

Reduction ring 150 mm
Article no. 81008070

Light.
For Generations.

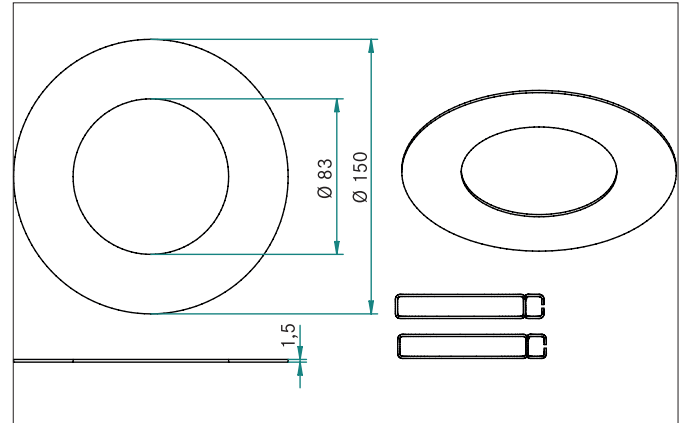
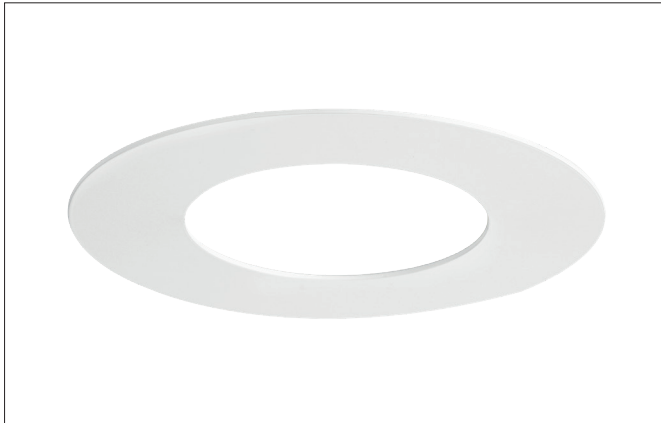

Tender

Reduction ring 150 mm, white, Round. Reduction ring is suitable for recessed spotlights with mounting springs. Outer diameter 150 mm (suitable for on-site ceiling cut-outs of up to 140 mm), inner diameter 83 mm, scope of delivery: 1 x reduction ring including 1 set of spring extension Material: Aluminium.

Article data	
Article no.	81008070
GTIN	4251433925071
Short description	Reduction ring 150 mm
Material	Aluminium
Colour	White
Type of surface	Matt
Shape	Round
Outer diameter	150 mm
Hight	1.5 mm
Weight	0.059 kg

Packing data	
Gross weight	0.063 kg
Length of packaging	155 mm
Packaging width	155 mm
Packaging hight	10 mm
Disposal at end of life	This product must not be disposed of with household waste. You are obliged, to dispose of such electrical waste separately. By disposing of electrical waste and other old or defective electronics separately, you support recycling or other forms of re-use. In that way you help to take care and to avoid that harmful substances get into the environment.

Reduction ring 150 mm
Article no. 81008070

Light.
For Generations.