

Reduction ring 180 mm
Article no. 81006150

Light.
For Generations.

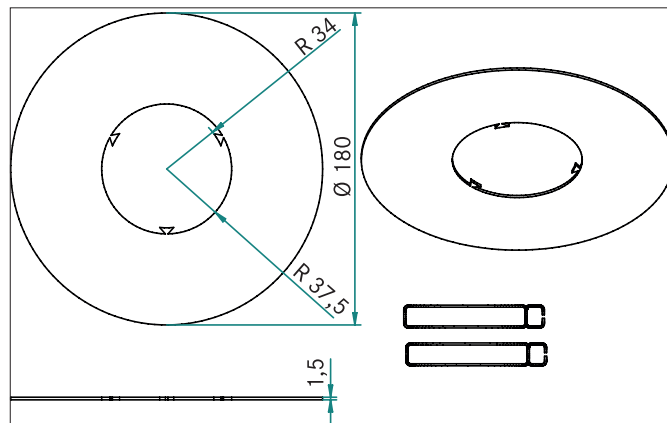
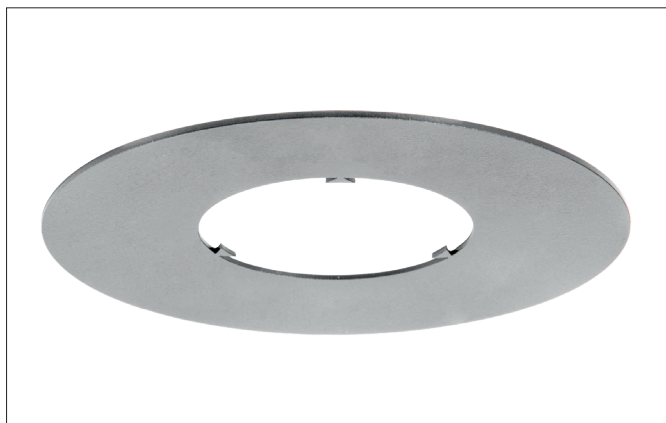

Tender
Reduction ring 180 mm, nickel satin, Round. Reduction ring is suitable for recessed spotlights with mounting springs. Outer diameter 180 mm (suitable for on-site ceiling cut-outs of up to 170 mm), inner diameter 68 or 74 mm (can be changed to 74 mm on the site), scope of delivery: 1 x reduction ring including 1 set of spring extension Material: Aluminium.

Article data	
Article no.	81006150
GTIN	4251433925002
Short description	Reduction ring 180 mm
Material	Aluminium
Colour	Nickel
Type of surface	Matt
Shape	Round
Outer diameter	180 mm
Hight	1.5 mm
Weight	0.095 kg

Packing data	
Gross weight	0.099 kg
Length of packaging	185 mm
Packaging width	185 mm
Packaging hight	10 mm
Disposal at end of life	This product must not be disposed of with household waste. You are obliged, to dispose of such electrical waste separately. By disposing of electrical waste and other old or defective electronics separately, you support recycling or other forms of re-use. In that way you help to take care and to avoid that harmful substances get into the environment.

Reduction ring 180 mm
Article no. 81006150

Light.
For Generations.