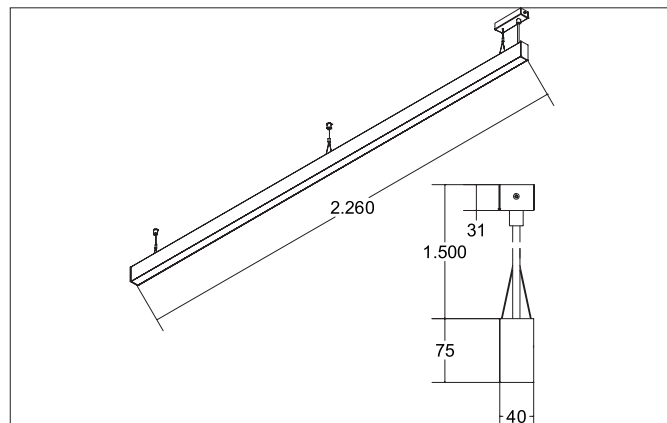

BIRO40 LED pendant profile luminaire direct

Article no. 77234694

Light.
For Generations.**Tender**

LED pendant profile luminaire direct, Rectangular. Luminaire length 2264.0 mm, Luminaire width 40.0 mm, Height 75.0 mm, for pendulum mounting. Pendulum length max. 1500.0 mm Weight 3.79 kg, with rotationssymmetrical, deep, wide distributed light intensity. optimal light distribution due to a plastic, microprismatic cover. Luminous flux 3.230 lm, UGR < 19, Power 35,8 W, Light colour neutral white, Correlated color temperature (CCT) 4.000 K, Colour rendering index CRI > 90, Rated life time L70/B50 at 25 °C: 60.000 h, Rated life time L80/B50 at 25 °C: 60.000 h, Housing material: Aluminium / Acrylic, Colour: Silver, Permissible ambient temperature (ta): -20 °C - +25 °C, Protection class (EN 61140): I, Degree of protection (DIN EN 60529): IP20, .With electronic driver, DALI dimmable.

Article data	
Article no.	77234694
GTIN	4251433934950
Series name	BIRO40
Short description	LED pendant profile luminaire direct
Material	Aluminium / Acrylic
Colour	Silver
Shape	Rectangular
Length	2,264 mm
Width	40 mm
Hight	75 mm
Weight	3.790 kg

BIRO40 LED pendant profile luminaire direct

Article no. 77234694

Light.
For Generations.

Lighting technology	
Colour temperature	4.000 K
Light colour	White
Light output	Direct
Luminous flux	3,230 lm
System efficiency	90 lm/W
McAdam-Step	McAdam-Step 3
Colour rendering	CRI > 90
Reflector	Without
Beam angle	80°
Glare evaluation	UGR < 19
Light sharing	Symmetric
Adjustable color temperature	No

Operating technology of the luminaire	
System output	35.8 W
Voltage type	AC
AC nominal voltage max	230 V
Frequenz max.	50 Hz
Lamp	LED
Lamp holder	Without fitting
Protection class	I
Degree of protection	IP20
Control	DALI
Rated life time L70/B50 at 25 °C	60,000 h
Rated life time L80/B50 at 25 °C	60.000 h

Mounting technology	
Mounting method	Suspended
Place of installation	Ceiling-mounted
Adjustability	Not adjustable
stamp	UKCA
Pendulum length max.	1,500 mm
Material cover	Plastic, microprismatic

Packing data	
Gross weight	4.58 kg
Length of packaging	2,300 mm
Packaging width	160 mm
Packaging height	135 mm
Disposal at end of life	This product must not be disposed of with household waste. You are obliged, to dispose of such electrical waste separately. By disposing of electrical waste and other old or defective electronics separately, you support recycling or other forms of re-use. In that way you help to take care and to avoid that harmful substances get into the environment.