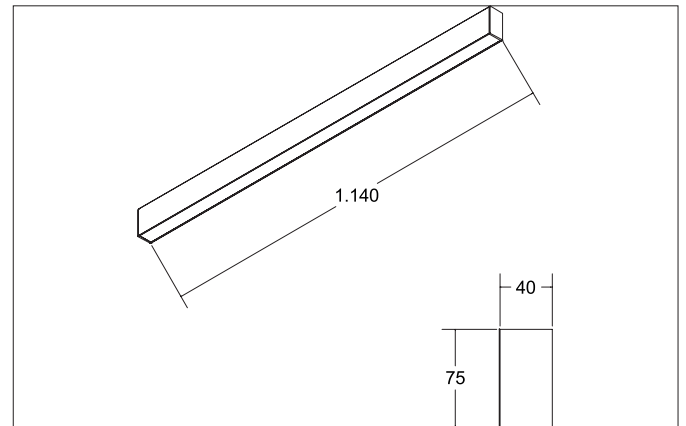
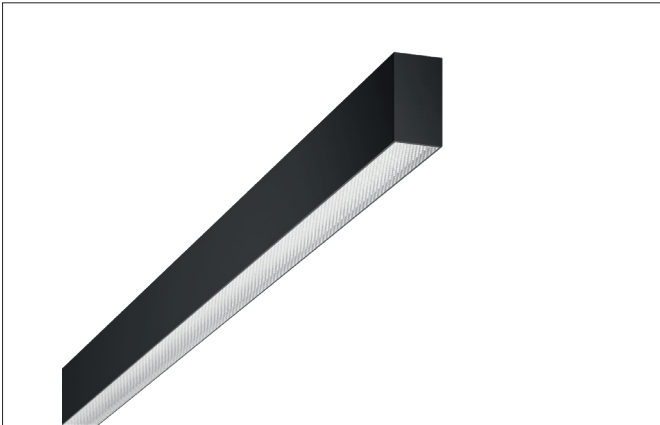

BIRO40 LED surface-mounted profile

Article no. 77133084

Light.
For Generations.**Tender**

LED surface-mounted profile, Rectangular. Luminaire length 1144.0 mm, Luminaire width 40.0 mm, Height 75.0 mm Weight 2.39 kg, with rotationssymmetrical, deep, wide distributed light intensity. optimal light distribution due to a plastic, microprismatic cover. Luminous flux 1.620 lm, UGR < 19, Power 17,9 W, Light colour neutral white, Correlated color temprature (CCT) 4.000 K, Colour rendering index CRI > 90, Rated life time L70/B50 at 25 °C: 60.000 h, Rated life time L80/B50 at 25 °C: 60.000 h, Housing material: Aluminium / Acrylic, Colour: Black, Permissible ambient temperature (ta): -20 °C - +25 °C, Protection class (EN 61140): I, Degree of protection (DIN EN 60529): IP20, .With electronic driver, DALI dimmable.

Article data	
Article no.	77133084
GTIN	4251433934479
Series name	BIRO40
Short description	LED surface-mounted profile
Material	Aluminium / Acrylic
Colour	Black
Shape	Rectangular
Length	1,144 mm
Width	40 mm
Hight	75 mm
Weight	2.390 kg

BIRO40 LED surface-mounted profile

Article no. 77133084

Light.
For Generations.

Lighting technology	
Colour temperature	4.000 K
Light colour	White
Light output	Direct
Luminous flux	1,620 lm
System efficiency	90 lm/W
McAdam-Step	McAdam-Step 3
Colour rendering	CRI > 90
Reflector	Without
Beam angle	80°
Glare evaluation	UGR < 19
Light sharing	Symmetric
Adjustable color temperature	No

Operating technology of the luminaire	
System output	17.9 W
Voltage type	AC
AC nominal voltage max	230 V
Frequency max	50 Hz
Lamp	LED
Lamp holder	Without fitting
Protection class	I
Degree of protection	IP20
Control	DALI
Rated life time L70/B50 at 25 °C	60,000 h
Rated life time L80/B50 at 25 °C	60.000 h

Mounting technology	
Mounting method	Surface mounting
Place of installation	Ceiling-mounted
Adjustability	Not adjustable
stamp	UKCA
Material cover	Plastic, microprismatic

Packing data	
Gross weight	2.84 kg
Length of packaging	1,250 mm
Packaging width	160 mm
Packaging height	135 mm
Disposal at end of life	This product must not be disposed of with household waste. You are obliged, to dispose of such electrical waste separately. By disposing of electrical waste and other old or defective electronics separately, you support recycling or other forms of re-use. In that way you help to take care and to avoid that harmful substances get into the environment.