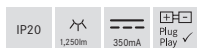
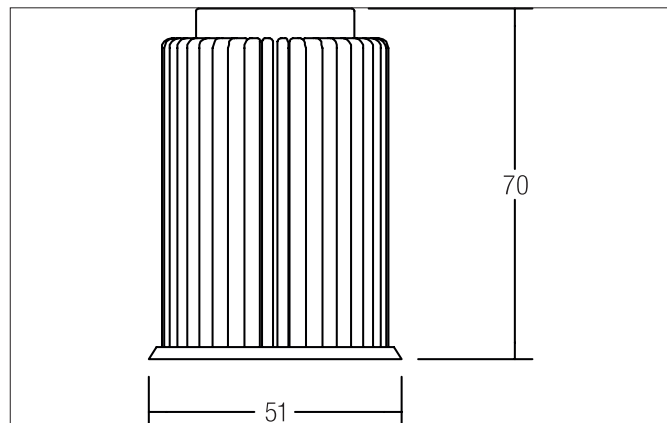

LED reflector insert MR16, 12 W

Artikel-Nr. 12953004

Licht.
Für Generationen.**Tender**

LED reflector insert MR16, 12 W, round. Lamp holder: Plug&Play, Material: Aluminium / Glass, Degree of protection: according to DIN EN 60529 IP20, Protection class: (EN 61140) III, Current: 350 mA, Power: 12W, Luminous flux: 1.250lm, Colour temperature: 4.000 K, Light colour : White, Beam angle: 38°, Control: Dimming depending on driver.

Article data

Artikel-Nr.	12953004
GTIN	4250047793168
Kurzbeschreibung	LED reflector insert MR16, 12 W
Material	Aluminium / Glass
Shape	Round
Outer diameter	50 mm
Hight	70 mm
weight	0.143 kg

Lighting technology









Colour temperature	4000 K
Light colour	White
Luminous flux	1,250 lm
System efficiency	104 lm/W
Colour rendering	CRI > 80
Reflector	High-gloss
Beam angle	38 °
Light sharing	Symmetric

LED reflector insert MR16, 12 W

Artikel-Nr. 12953004

Licht.
Für Generationen.

Packing data	
Gross weight	0.161 kg
Length of packaging	60 mm
Packaging width	60 mm
Packaging height	83 mm

Accessories	
	<p>Artikel-Nr.: 17613000 Kurzbeschreibung: LED converter 350 mA, on/off Leistung: 1 - 15 W Abmessung: 115 mm x 34 mm x 19 mm</p>
	<p>Artikel-Nr.: 17621020 Kurzbeschreibung: LED converter 350 mA, on/off Leistung: 1 - 21 W Abmessung: 128 mm x 50 mm x 13 mm</p>
	<p>Artikel-Nr.: 17664020 Kurzbeschreibung: LED converter 350 mA, trailing-edge phase dimmable Leistung: 10,2 - 14 W Abmessung: 125 mm x 51 mm x 20 mm</p>
	<p>Artikel-Nr.: 17643020 Kurzbeschreibung: LED converter 350 mA, trailing-edge phase dimmable Leistung: 8,8 - 18 W Abmessung: 110 mm x 52 mm x 22 mm</p>
	<p>Artikel-Nr.: 17657000 Kurzbeschreibung: LED converter 350 mA, 1-10 V dimmable (analog) Leistung: 5,2 - 18 W Abmessung: 110.5 mm x 52 mm x 22 mm</p>
	<p>Artikel-Nr.: 17683020 Kurzbeschreibung: LED converter 350 mA, DALI dimmable (digital) Leistung: 3,5 - 17 W Abmessung: 110.5 mm x 52 mm x 22 mm</p>
	<p>Artikel-Nr.: 17648020 Kurzbeschreibung: LED converter 350 mA, trailing-edge phase dimmable Leistung: 0,7 - 17 W Abmessung: 166 mm x 46 mm x 34 mm</p>
	<p>Artikel-Nr.: 17671020 Kurzbeschreibung: LED converter 350mA, ZigBee dimmable Leistung: 3,5 - 18,5 W Abmessung: 146.5 mm x 44 mm x 30 mm</p>
	<p>Artikel-Nr.: 17672020 Kurzbeschreibung: LED converter 350mA, Casambi dimmable Leistung: 3,5 - 18 W Abmessung: 146.5 mm x 44 mm x 30 mm</p>