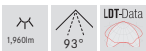
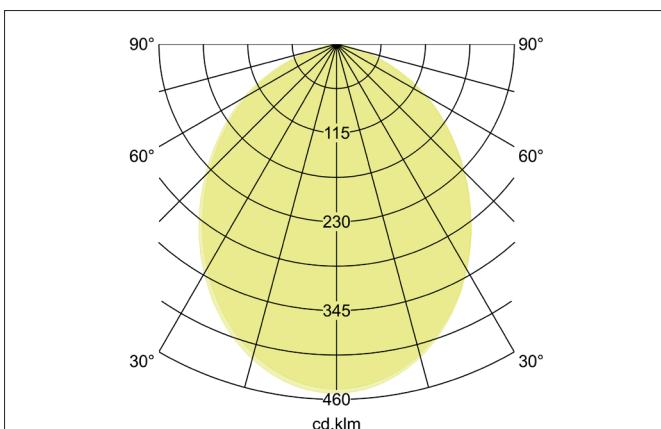
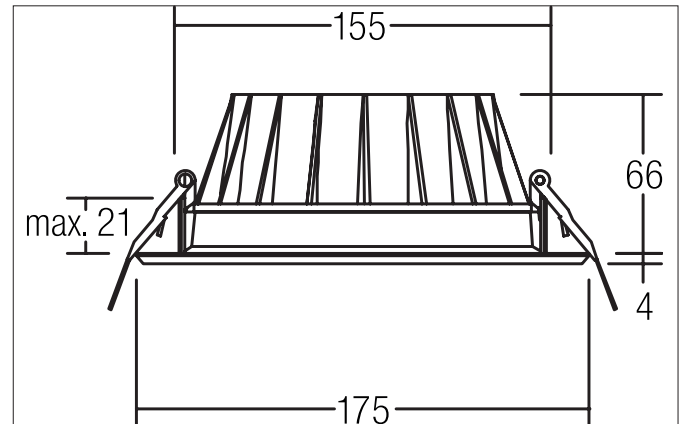

BOWL MIDI LED recessed downlight

Article no. 12528074

Light.
For Generations.**Tender**

LED recessed downlight, Round. Toolless ceiling installation by installation springs. Ceiling cut-out Ø 155 mm, Installation depth 66 mm, Outer diameter 175 mm, Weight 0,481 kg, with rotationssymmetrical, deep, wide distributed light intensity. optimal light distribution due to a plastic, opal cover. Luminous flux 1.960 lm, Power 1 x 20 W, System Efficiency 98 lm/W, Light colour neutral white, Correlated color temperature (CCT) 4.000 K, Colour rendering index CRI > 80, Rated life time L70/B50 at 25 °C: 50000 h, Housing material: Aluminium / PMMA, Colour: White, Permissible ambient temperature (ta): -20 °C - +25 °C, Protection class (EN 61140): III, Degree of protection (DIN EN 60529): IP20. For connection to an external driver, which is not included in the scope of delivery of the luminaire. Depending on driver dimmable.

Product Benefits

- Recessed downlight in round design made of solid aluminum with opal PMMA cover
- Ceiling cutout 155 mm, outer diameter 175 mm, installation depth 66 mm, luminous flux 1,330 / 1,960 lm, IP20.
- Recessed light emission.
- Dimmable when using a suitable converter.
- Alternatively available in two other sizes.

BOWL MIDI LED recessed downlight

Article no. 12528074

Light.
For Generations.

Article data	
Article no.	12528074
GTIN	4251433917823
Series name	BOWL MIDI
Short description	LED recessed downlight
Material	Aluminium / PMMA
Colour	White
Type of surface	Matt
Shape	Round
Outer diameter	175 mm
Built-in diameter	155 mm
Installation depth	66 mm
Hight	4 mm
Weight	0.481 kg

Lighting technology	
Colour temperature	4.000 K
Light colour	White
Light output	Direct
Luminous flux	1,960 lm
System efficiency	98 lm/W
Colour rendering	CRI > 80
Reflector	Without
Beam angle	93°
Light sharing	Symmetric

Operating technology of the luminaire	
Voltage type	DC
Current	500 mA
Lamp	LED
Protection class	III
Degree of protection	IP20
Dimmable	Depending on type of control gear
Control	Depending on driver
Bulb change possible	The light source of this luminaire may only be replaced by the manufacturer or a service technician commissioned by him or a similarly qualified person.
Rated life time L70/B50 at 25 °C	50,000 h





Mounting technology	
Mounting method	Recessed mounting
Place of installation	Ceiling-mounted
Adjustability	Not adjustable
Max. ceiling thickness	21 mm
Further references	No cover with thermal insulation material
Material cover	Plastic, opal

Packing data	
Gross weight	0.719 kg
Length of packaging	260 mm
Packaging width	195 mm
Packaging hight	105 mm
Disposal at end of life	This product must not be disposed of with household waste. You are obliged, to dispose of such electrical waste separately. By disposing of electrical waste and other old or defective electronics separately, you support recycling or other forms of re-use. In that way you help to take care and to avoid that harmful substances get into the environment.

BOWL MIDI LED recessed downlight

Article no. 12528074

Light.
For Generations.

Accessories	
	<p>Article no.: 17823010 LED converter 500 mA, on/off switchable Power: 1 - 22 W Dimensions: 146 mm x 43.5 mm x 30 mm</p>
	<p>Article no.: 17822010 LED converter 500 mA, trailing-edge phase dimmable Power: 8 - 20 W Dimensions: 110 mm x 52 mm x 22 mm</p>
	<p>Article no.: 17829010 LED converter 500 mA, trailing-edge phase dimmable Power: 1 - 24 W Dimensions: 166 mm x 46 mm x 34 mm</p>
	<p>Article no.: 17824010 LED converter 500 mA, 1-10V dimmable (analog) Power: 5 - 27 W Dimensions: 146 mm x 43.5 mm x 30 mm</p>
	<p>Article no.: 17826010 LED converter 500 mA, DALI dimmable (digital) Power: 5 - 27 W Dimensions: 146 mm x 44 mm x 30 mm</p>