

ALTERO-S LED recessed downlight, IP44
 Article no. 12036403

Light.
 For Generations.

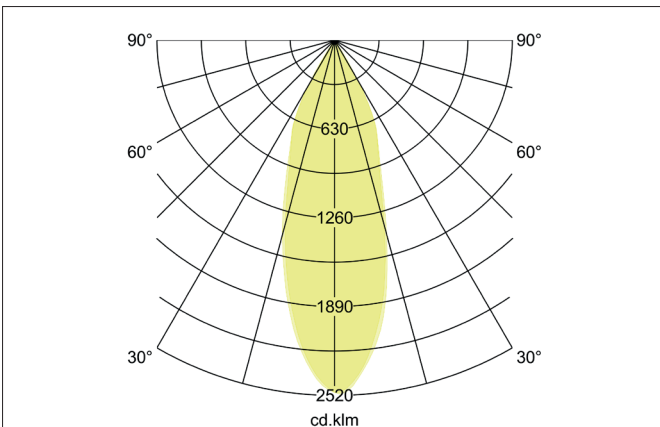
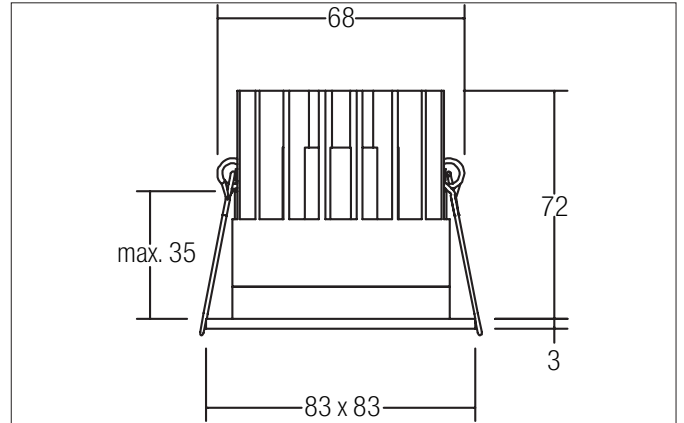

Tender
 LED recessed downlight, IP44, Square. Toolless ceiling installation by installation springs. Ceiling cut-out Ø 68 mm, Installation depth 72 mm, Length 83 mm, Width 83 mm, Weight 0,274 kg, Reflector silver with rotationssymmetrical, deep, wide distributed light intensity. optimal light distribution due to a glass transparent cover. Luminous flux 820 lm, Power 1 x 9,2 W, System Efficiency 89 lm/W, Light colour warm white, Correlated color temprature (CCT) 3.000 K, Colour rendering index CRI > 80, Housing material: Aluminium, Colour: White / Chrome structure, Permissible ambient temperature (ta): -20 °C - +25 °C, Protection class (EN 61140): III, Degree of protection (DIN EN 60529): IP44 when installing in closed ceilings. For connection to an external driver, which is not included in the scope of delivery of the luminaire. Depending on driver dimmable.

Article data	
Article no.	12036403
GTIN	4251433915928
Series name	ALTERO-S
Short description	LED recessed downlight, IP44
Material	Aluminium
Colour	White / Chrome
Type of surface	Structure
Shape	Square
Built-in diameter	68 mm
Installation depth	72 mm
Length	83 mm
Width	83 mm
Height	3 mm
Weight	0.274 kg

ALTERO-S LED recessed downlight, IP44

Article no. 12036403

Light.
For Generations.

Lighting technology	
Colour temperature	3.000 K
Light colour	White
Light output	Direct
Luminous flux	820 lm
System efficiency	89 lm/W
Colour rendering	CRI > 80
Reflector	High-gloss
Reflektorfarbe	silver
Beam angle	33°
Light sharing	Symmetric

Operating technology of the luminaire	
System output	9.2 W
Voltage type	DC
Current	500 mA
Lamp	LED
Protection class	III
Degree of protection	IP44
Schutzart deckenseitig	IP20
Dimmable	Depending on type of control gear
Control	Depending on driver
Bulb change possible	The light source of this luminaire may only be replaced by the manufacturer or a service technician commissioned by him or a similarly qualified person.





Mounting technology	
Mounting method	Recessed mounting
Place of installation	Ceiling-mounted
Adjustability	Not adjustable
Max. ceiling thickness	35 mm
Further references	No cover with thermal insulation material
Material cover	Glass transparent

Packing data	
Gross weight	0.324 kg
Length of packaging	100 mm
Packaging width	100 mm
Packaging height	100 mm
Disposal at end of life	This product must not be disposed of with household waste. You are obliged, to dispose of such electrical waste separately. By disposing of electrical waste and other old or defective electronics separately, you support recycling or other forms of re-use. In that way you help to take care and to avoid that harmful substances get into the environment.

ALTERO-S LED recessed downlight, IP44

Article no. 12036403

Light.
For Generations.

Accessories	
	<p>Article no.: 17823010 LED converter 500 mA, on/off switchable Power: 1 - 22 W Dimensions: 146 mm x 43.5 mm x 30 mm</p>
	<p>Article no.: 17822010 LED converter 500 mA, trailing-edge phase dimmable Power: 8 - 20 W Dimensions: 110 mm x 52 mm x 22 mm</p>
	<p>Article no.: 17829010 LED converter 500 mA, trailing-edge phase dimmable Power: 1 - 24 W Dimensions: 166 mm x 46 mm x 34 mm</p>
	<p>Article no.: 17824010 LED converter 500 mA, 1-10V dimmable (analog) Power: 5 - 27 W Dimensions: 146 mm x 43.5 mm x 30 mm</p>
	<p>Article no.: 17826010 LED converter 500 mA, DALI dimmable (digital) Power: 5 - 27 W Dimensions: 146 mm x 44 mm x 30 mm</p>