



BRUMBERG

Light. Since 1873.

B-LIGHT™

**The lighting trunking system
that simply works.
Smartly designed. Quickly installed.**

www.brumberg.com

B-LIGHT™.

The lighting trunking system that simply works.

Smartly designed. Quickly installed.

The BRUMBERG B-LIGHT™ quick-assembly lighting trunking system has a modular design. Each element fulfills a clear function - and all interlock precisely. The system remains consistent, logical and easy to install, from the mounting and power supply to the lighting technology and the end/feed-in boxes. Four components - for light that simply works.

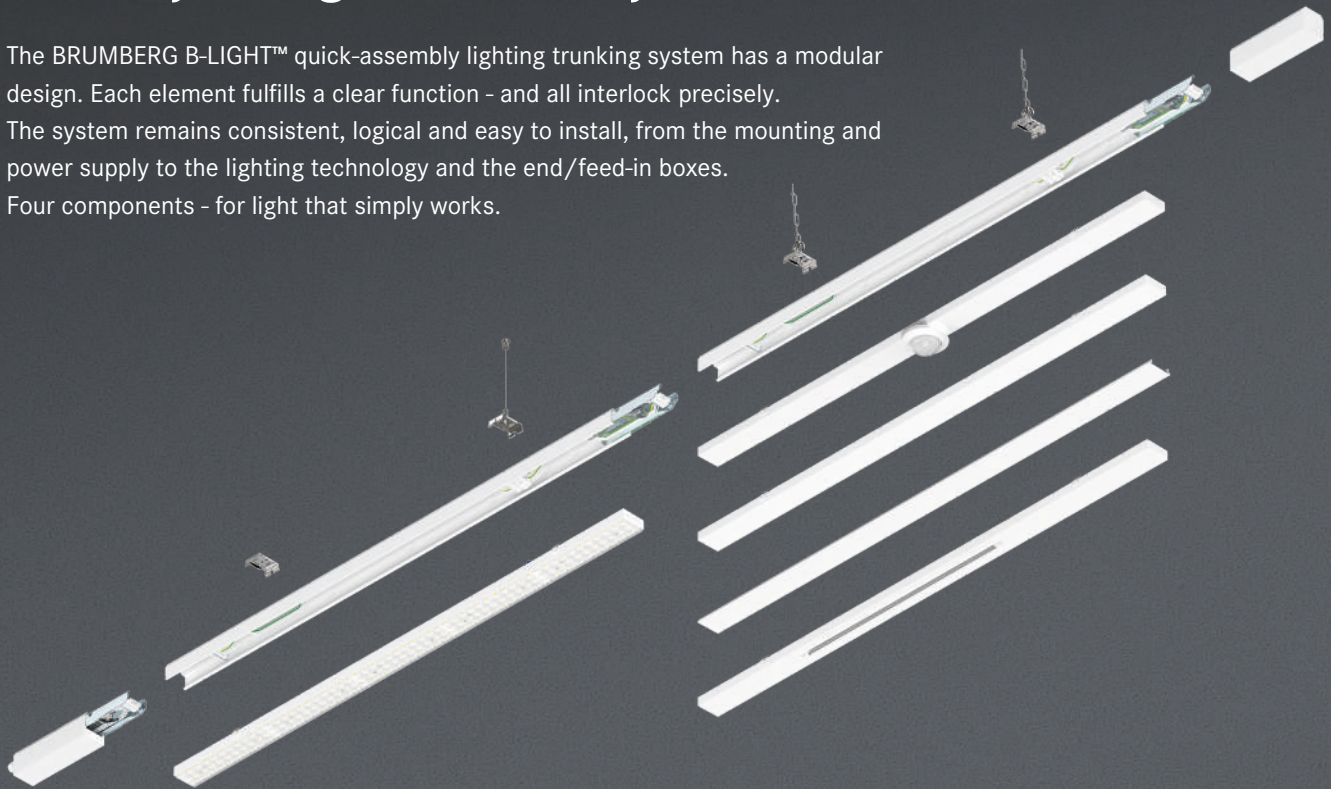

Cost-effective from installation to operation.

Reduced installation effort, efficient LED technology and high operational reliability.

- + Modular lighting trunking system with clearly defined system logic.** For simple expansion and adaptation to any building structure.
- + Four clearly structured system components.** interlock precisely - reliably from planning to implementation.
- + High system efficiency.** Up to 180 lm/W. Maximum luminous efficacy (up to 13,800 lm) with minimum consumption.
- + Flexible and scalable.** 3 lengths, 2 housing colors, 3 light colors, 7 beam angles and extension with sensors and spotlights.
- + Flexibly controllable and performance-efficient.** DALI control and multilumen technology offer maximum adaptability with minimum effort.
- + Lightweight, robust, durable.** Trunking rail and gear tray made of aluminum.
- + Quickly installed. Ready to operate immediately.** Pre-assembled trunking rails, integrated cable routing and a tool-free click system reduce installation time and sources of error.
- + Suitable for the workplace, glare-free and efficient.** Optional UGR < 19 for standard-compliant work and sales areas.
- + 5-year BRUMBERG lighting guarantee.** After registration on the Brumberg website. Reliable quality for every project size.



Areas of application.

Industry. Robust and efficient for production, warehouses, logistics and workshops. Uniform, glare-free light for precise work and maximum availability.

Shop & Retail. Precise, flexible light for product presentation and room staging. Combines efficiency with strong sales appeal.

Four system components.

Clearly structured. Safely designed.

1. Trunking rail



Trunking rail, 7- and 11-pole

2. Trunking rail accessories

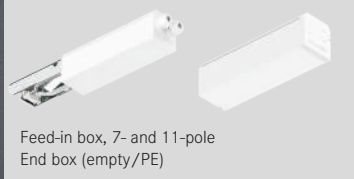

Feed-in box, 7- and 11-pole
End box (empty/PE)

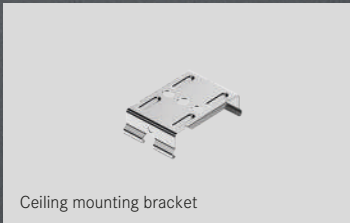

Ceiling mounting bracket



Steel wire suspension

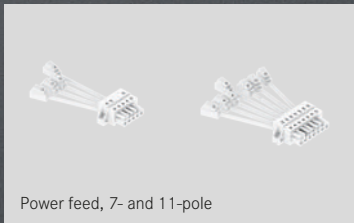

Power feed, 7- and 11-pole

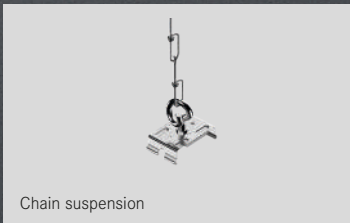

Chain suspension

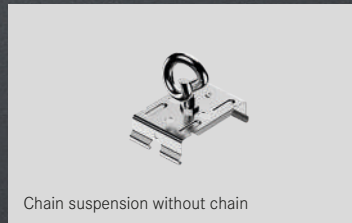

Chain suspension without chain

3. Gear tray / light module



Gear tray, 3- and 5-pole

4. System accessories

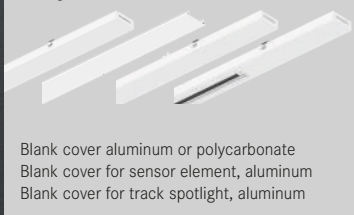

Blank cover aluminum or polycarbonate
Blank cover for sensor element, aluminum
Blank cover for track spotlight, aluminum



RETAIL ONE track spotlights

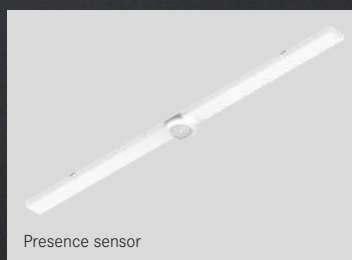

Presence sensor



Technical features & advantages.

[+] Stable basic structure. Robust aluminum profile with precise guidance - for secure installation and a long service life.

[+] Integrated cable routing. Pre-wired rails with continuous conductor tracks - for fast, error-free installation.

[+] Tool-free connection. Plug-in system with click mechanism—simple end-to-end linking without additional accessories.

[+] Variable feed. Optional power feed from the left, right or center via preconfigured connection points.

[+] Compatible system logic. All gear trays and accessory components fit exactly into the rail holder.

[+] Flexible installation options. Direct mounting, cable or chain suspension - the right solution for every room geometry.

[+] High operational reliability. Mechanically torsion-proof, electrically reliable - tested to current standards.

B-LIGHT™. Trunking rails.

The base – stable, precise, intelligent.

The trunking rail forms the backbone of the entire system. It contains the complete power and control cable infrastructure – pre-assembled, reverse polarity protected and ready for immediate use. Made of aluminum, it is lightweight, torsion-resistant and corrosion-resistant. The low weight makes transportation, handling and installation easier – especially for longer system distances or overhead installations. A secure electrical connection is automatically established between the trunking rails when they engage, which can be stabilized by a hinge. This saves time, reduces sources of error and ensures permanently stable connections.

Article no.	Designation	Color	Number of poles	Length	Description	Price in €
55001070	BTS 1438-7 ws	white	7-pole	1,438 mm	Halogen-free cable 2.5 mm ² (L1, L2, L3, N, PE, DIM+, DIM-)	64.90
55002070	BTS 2876-7 ws	white	7-pole	2,876 mm	Halogen-free cable 2.5 mm ² (L1, L2, L3, N, PE, DIM+, DIM-)	99.90
55003070	BTS 4314-7 ws	white	7-pole	4,314 mm	Halogen-free cable 2.5 mm ² (L1, L2, L3, N, PE, DIM+, DIM-)	154.90
55011070	BTS 1438-11 ws	white	11-pole	1,438 mm	Halogen-free cable 2.5 mm ² (L1, L2, L3, N, PE, DIM+, DIM-, EL1, EL2, EN1, EN2)	84.90
55012070	BTS 2876-11 ws	white	11-pole	2,876 mm	Halogen-free cable 2.5 mm ² (L1, L2, L3, N, PE, DIM+, DIM-, EL1, EL2, EN1, EN2)	149.90
55013070	BTS 4314-11 ws	white	11-pole	4,314 mm	Halogen-free cable 2.5 mm ² (L1, L2, L3, N, PE, DIM+, DIM-, EL1, EL2, EN1, EN2)	194.90
55001080	BTS 1438-7 sw	black	7-pole	1,438 mm	Halogen-free cable 2.5 mm ² (L1, L2, L3, N, PE, DIM+, DIM-)	64.90
55002080	BTS 2876-7 sw	black	7-pole	2,876 mm	Halogen-free cable 2.5 mm ² (L1, L2, L3, N, PE, DIM+, DIM-)	99.90
55003080	BTS 4314-7 sw	black	7-pole	4,314 mm	Halogen-free cable 2.5 mm ² (L1, L2, L3, N, PE, DIM+, DIM-)	154.90
55011080	BTS 1438-11 sw	black	11-pole	1,438 mm	Halogen-free cable 2.5 mm ² (L1, L2, L3, N, PE, DIM+, DIM-, EL1, EL2, EN1, EN2)	84.90
55012080	BTS 2876-11 sw	black	11-pole	2,876 mm	Halogen-free cable 2.5 mm ² (L1, L2, L3, N, PE, DIM+, DIM-, EL1, EL2, EN1, EN2)	149.90
55013080	BTS 4314-11 sw	black	11-pole	4,314 mm	Halogen-free cable 2.5 mm ² (L1, L2, L3, N, PE, DIM+, DIM-, EL1, EL2, EN1, EN2)	194.90

These articles are subject to discount group 3.

white = RAL 9016, black = RAL 9005

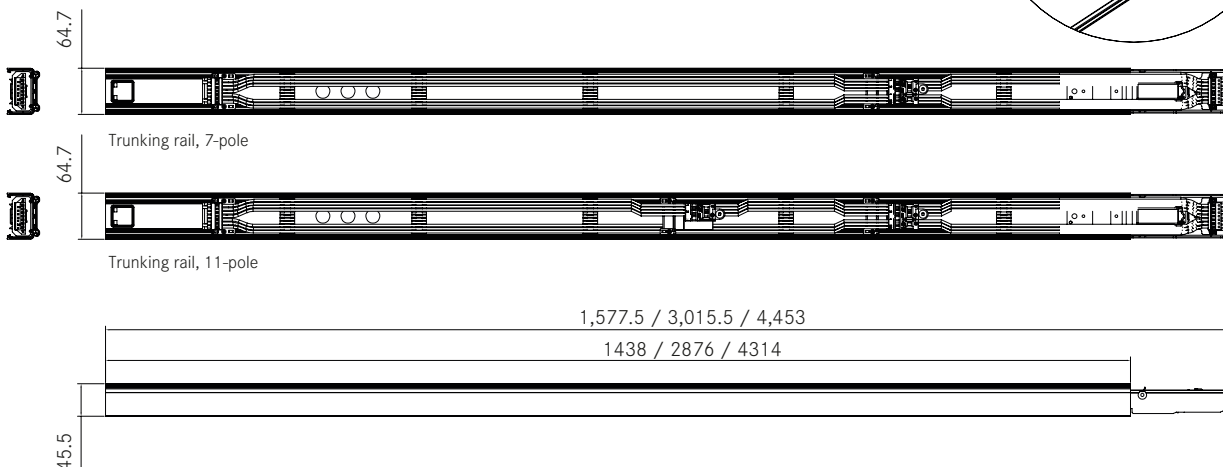
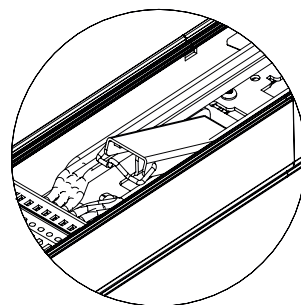

B-LIGHT™. Trunking rail accessories.

Power and installation—perfectly integrated.

The accessories of the BRUMBERG B-LIGHT™ combine intelligent energy supply and flexible mounting systems in a sophisticated concept. Lightweight, stable and easy to install, it ensures secure connections, clean installations and maximum efficiency - from the feed to the bracket.



Feed-in box, 7- and 11-pole

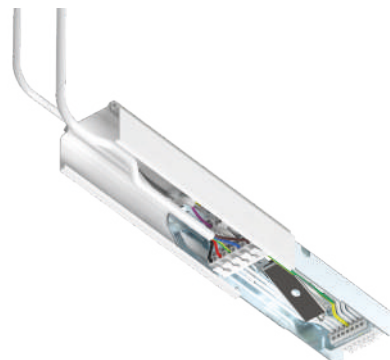

End box 237 mm (empty/PE)



Feed plug (socket), 7- and 11-pole

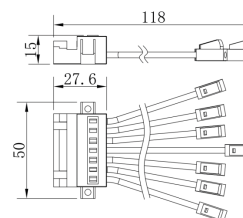

End feed plug, 7- and 11-pole

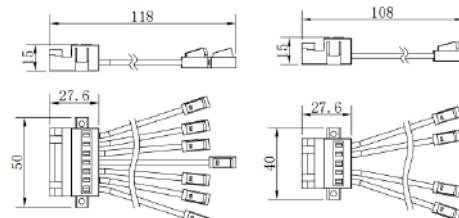
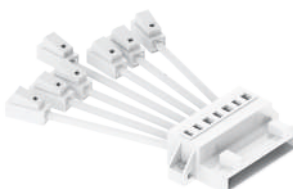

Ceiling fixture



Steel wire suspension



Chain suspension bracket (without chain)



Chain suspension

Feed-in box

Article no.	Designation	Color	Number of poles	Length	Description	Price in €
55090070	BESB-7 ws	white	7-pole	237 mm	Feed-in box halogen-free cable 2.5 mm ² (L1, L2, L3, N, PE, DIM+, DIM-)	61.00
55091070	BESB-11 ws	white	11-pole	237 mm	Feed-in box halogen-free cable 2.5 mm ² , (L1, L2, L3, N, PE, DIM+, DIM-, EL1, EL2, EN1, EN2)	79.00
55090080	BESB-7 sw	black	7-pole	237 mm	Feed-in box halogen-free cable 2.5 mm ² (L1, L2, L3, N, PE, DIM+, DIM-)	61.00
55091080	BESB-11 sw	black	11-pole	237 mm	Feed-in box halogen-free cable 2.5 mm ² , (L1, L2, L3, N, PE, DIM+, DIM-, EL1, EL2, EN1, EN2)	79.00
55095070	BESB-0 ws	white		237 mm	End box (empty/PE)	26.00
55095080	BESB-0 sw	black		237 mm	End box (empty/PE)	26.00

These articles are subject to discount group 3.

white = RAL 9016, black = RAL 9005

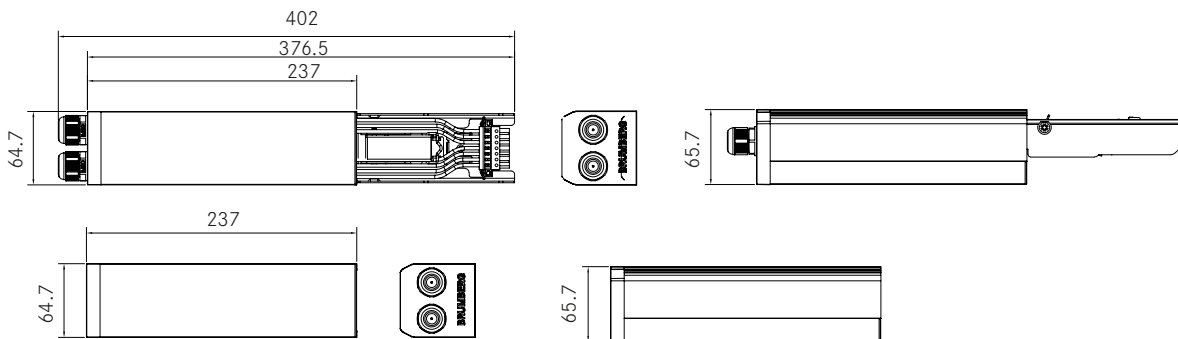

The feed-in box is attached to the end of the trunking rail. It provides the power and control feed for the entire lighting line. An end box is installed on the opposite side for electrical and mechanical protection.

The box features a clip for quick, tool-free installation, 2 PG cable glands and either a 7- or 11-pole connector for the track.

The result is a clean finish - functional and visually uniform.

Direct feed

Article no.	Designation	Number of poles	Description	Price in €
55070000	BESSB-7	7-pole	Feed plug (socket) , Halogen-free cable 2.5 mm ² (L1, L2, L3, N, PE, DIM+, DIM-), trunking rail	16.00
55080000	BESSB-11	11-pole	Feed plug (socket) , halogen-free cable 2.5 mm ² , (L1, L2, L3, N, PE, DIM+, DIM-, EL1, EL2, EN1, EN2), trunking rail	29.00
55071000	BEESB-7	7-pole	End-feed plug for end box with plug, halogen-free cable 2.5 mm ² , (L1, L2, L3, N, PE, DIM+, DIM-), trunking rail, compatible with 55095070, 55095080	16.00
55081000	BEESB-11	11-pole	End-feed plug for end box with plug, halogen-free cable 2.5 mm ² , (L1, L2, L3, N, PE, DIM+, DIM-, EL1, EL2, EN1, EN2), trunking rail, compatible with 55095070, 55095080	29.00

These articles are subject to discount group 3.

For projects with concealed wiring or multiple feed points, the lighting trunking system offers the option of routing the supply cable directly through pre-marked areas in the trunking rail - on the left, center or right.

After the routing, the cable is simply plugged into the feed adapter, which immediately establishes contact with the integrated conductor tracks of the rail.

No open wiring, no screws - Plug & Power.

Advantages:

- [+] Flexible positioning of the feed-in point
- [+] Ideal for concealed cable routes or connection via ceiling ducts
- [+] No additional components outside the light line
- [+] Tool-free installation
- [+] Marked phase and neutral conductors
- [+] Suitable for mains and control cables

Article no.	Designation	Description	Price in €
55006000	BHD M6	Ceiling mounting M6, trunking rail	3.50
55010000	BHD M10	Ceiling mounting M10, trunking rail	3.50
55032000	BHS 2.0	Steel wire suspension, length 2 m	15.90
55033000	BHS 3.0	Steel wire suspension, length 3 m	19.90
55034000	BHS 4.0	Steel wire suspension, length 4 m	23.90
55035000	BHS 5.0	Steel wire suspension, length 5 m	27.90

These articles are subject to discount group 3.

Article no.	Designation	Description	Price in €
55052000	BHK 2.0	Chain suspension 2 m, trunking rail	27.90
55055000	BHK 5.0	Chain suspension 5 m, trunking rail	39.90
55060000	BHK	Chain suspension bracket without chain, trunking rail	5.50

These articles are subject to discount group 3.

LED LIGHTING
FUNDING

BEG

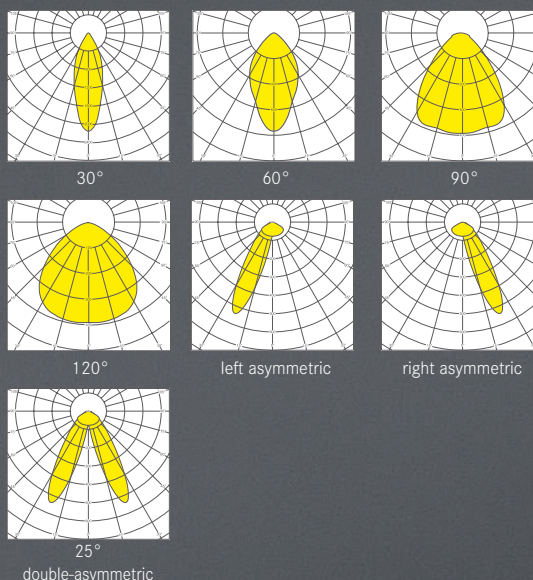

Technical features & advantages.

- [+] Efficient LED technology and optimized thermal management** for consistently high light quality.
- [+] Multilumen function.** Variable lumen packages with simple adjustment – one luminaire insert for multiple output levels.
- [+] Glare-free light.** $UGR \leq 19$ - for pleasant lighting conditions in work and recreation areas.
- [+] Optical variety for every application.** 30°, 60°, 90°, 120°, asymmetric and double-asymmetric - from accentuated light to homogeneous area illumination.
- [+] DALI-compatible.** For smart, individual lighting control in modern buildings and system installations.
- [+] Quickly installed, precisely positioned.** The click mechanism ensures tool-free installation, while the coded plug-in guide guarantees precise and error-proof installation.
- [+] Expandable with sensors & spotlights.** Prepared for light management, presence detectors and track spotlights.
- [+] Reliable light output.** Constantly high output, flicker-free and color-stable - for standard-compliant lighting in all applications.

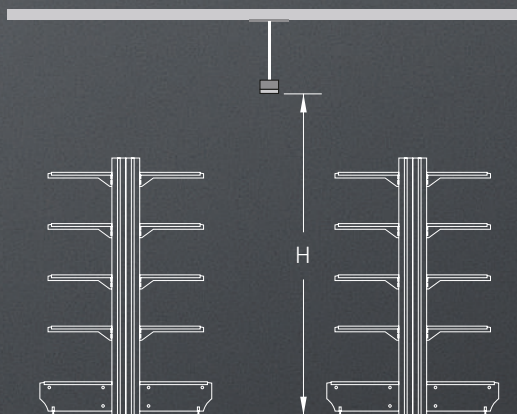

Beam angle and recommended installation height:

- [1] Narrow beam (30°) - targeted accentuation, H = 6 - 12 m
- [2] Medium beam (60°) - balanced ambient light, H = 5 - 10 m
- [3] Wide beam (90°) - planar illumination, H = 3 - 5 m
- [4] Extra Wide Beam (120°) - for low ceilings, H = 2 - 5 m
- [5] Asymmetric left/right - directional area lighting, H = 4 - 10 m
- [6] Double-asymmetric 25° - surface illumination on both sides, H = 4 - 12 m

B-LIGHT™. Gear tray.

Efficient light modules for surface-mounting.

The trunking rail carries power and control, while the gear tray delivers the light. Fitted with a click, automatically locked and immediately ready for use - no wiring, no tools required. Integrated LED modules, precise lenses and intelligent driver electronics ensure efficient, glare-free light exactly where it is needed.

Article no.	Designation	Color	Color temperature	Beam angle	UGR	Lumen max.	System efficiency min.	CRI	Length	Number of poles	Control	Price in €
55101074	BGT 13800 ET K4000 ws	white	4,000 K	30°	< 22	13,800 lm	180 lm/W	> 80	1,438 mm	3-pole	switchable	189.90
55102074	BGT 13800 T K4000 ws	white	4,000 K	60°	< 22	13,800 lm	180 lm/W	> 80	1,438 mm	3-pole	switchable	189.90
55103074	BGT 13800 B K4000 ws	white	4,000 K	90°	< 22	13,800 lm	180 lm/W	> 80	1,438 mm	3-pole	switchable	189.90
55105074	BGT 13800 EB K4000 ws	white	4,000 K	120°	< 22	13,800 lm	180 lm/W	> 80	1,438 mm	3-pole	switchable	189.90
55106074	BGT 13800 LAS K4000 ws	white	4,000 K	1 x 25° asym. L	< 22	13,800 lm	180 lm/W	> 80	1,438 mm	3-pole	switchable	189.90
55107074	BGT 13800 DAS K4000 ws	white	4,000 K	2 x 25° asym.	< 22	13,800 lm	180 lm/W	> 80	1,438 mm	3-pole	switchable	189.90
55101074DA	BGT 13500 ET K 4000 DA ws	white	4,000 K	30°	< 22	13,500 lm	180 lm/W	> 80	1,438 mm	5-pole	DALI	229.90
55102074DA	BGT 13500 T K4000 DA ws	white	4,000 K	60°	< 22	13,500 lm	180 lm/W	> 80	1,438 mm	5-pole	DALI	229.90
55103074DA	BGT 13500 B K4000 DA ws	white	4,000 K	90°	< 22	13,500 lm	180 lm/W	> 80	1,438 mm	5-pole	DALI	229.90
55104074DA	BGT 4500 UGR K4000 DA ws	white	4,000 K	90°	< 19	4,500 lm	180 lm/W	> 80	1,438 mm	5-pole	DALI	239.90
55105074DA	BGT 13500 EB K4000 DA ws	white	4,000 K	120°	< 22	13,500 lm	180 lm/W	> 80	1,438 mm	5-pole	DALI	229.90
55106074DA	BGT 13500 LAS K4000 DA ws	white	4,000 K	1 x 25° asym. L	< 22	13,500 lm	180 lm/W	> 80	1,438 mm	5-pole	DALI	229.90
55107074DA	BGT 13500 DAS K4000 DA ws	white	4,000 K	2 x 25° asym.	< 22	13,500 lm	180 lm/W	> 80	1,438 mm	5-pole	DALI	229.90
55101084	BGT 13800 ET K4000 sw	black	4,000 K	30°	< 22	13,800 lm	180 lm/W	> 80	1,438 mm	3-pole	switchable	189.90
55102084	BGT 13800 T K4000 sw	black	4,000 K	60°	< 22	13,800 lm	180 lm/W	> 80	1,438 mm	3-pole	switchable	189.90
55103084	BGT 13800 B K4000 sw	black	4,000 K	90°	< 22	13,800 lm	180 lm/W	> 80	1,438 mm	3-pole	switchable	189.90
55105084	BGT 13800 EB K4000 sw	black	4,000 K	120°	< 22	13,800 lm	180 lm/W	> 80	1,438 mm	3-pole	switchable	189.90
55106084	BGT 13800 LAS K4000 sw	black	4,000 K	1 x 25° asym. L	< 22	13,800 lm	180 lm/W	> 80	1,438 mm	3-pole	switchable	189.90
55106084	BGT 13800 DAS K4000 sw	black	4,000 K	2 x 25° asym.	< 22	13,800 lm	180 lm/W	> 80	1,438 mm	3-pole	switchable	189.90
55101084DA	BGT 13500 ET K4000 DA sw	black	4,000 K	30°	< 22	13,500 lm	180 lm/W	> 80	1,438 mm	5-pole	DALI	229.90
55102084DA	BGT 13500 T K4000 DA sw	black	4,000 K	60°	< 22	13,500 lm	180 lm/W	> 80	1,438 mm	5-pole	DALI	229.90
55103084DA	BGT 13500 B K4000 DA sw	black	4,000 K	90°	< 22	13,500 lm	180 lm/W	> 80	1,438 mm	5-pole	DALI	229.90
55104084DA	BGT 4500 UGR K4000 DA sw	black	4,000 K	90°	< 19	4,500 lm	180 lm/W	> 80	1,438 mm	5-pole	DALI	239.90
55105084DA	BGT 13500 EB K4000 DA sw	black	4,000 K	120°	< 22	13,500 lm	180 lm/W	> 80	1,438 mm	5-pole	DALI	229.90
55106084DA	BGT 13500 LAS K4000 DA sw	black	4,000 K	1 x 25° asym. L	< 22	13,500 lm	180 lm/W	> 80	1,438 mm	5-pole	DALI	229.90
55107084DA	BGT 13500 DAS K4000 DA sw	black	4,000 K	2x 25° asym.	< 22	13,500 lm	180 lm/W	> 80	1,438 mm	5-pole	DALI	229.90

These articles are subject to discount group 3.

white = RAL 9016, black = RAL 9005

Asymmetric right and other color temperatures on request.

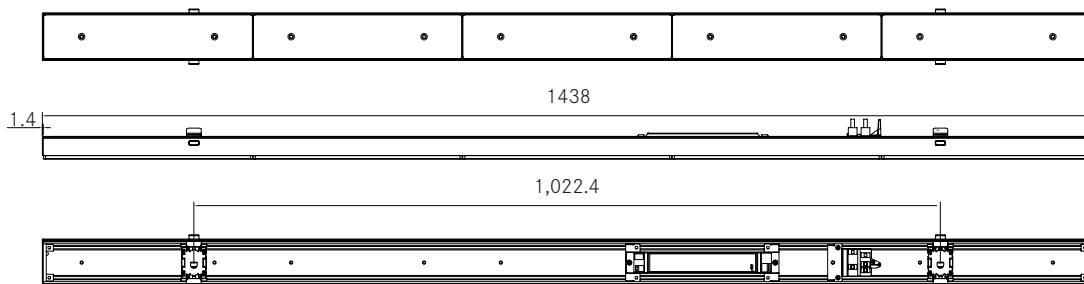
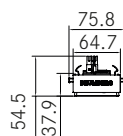

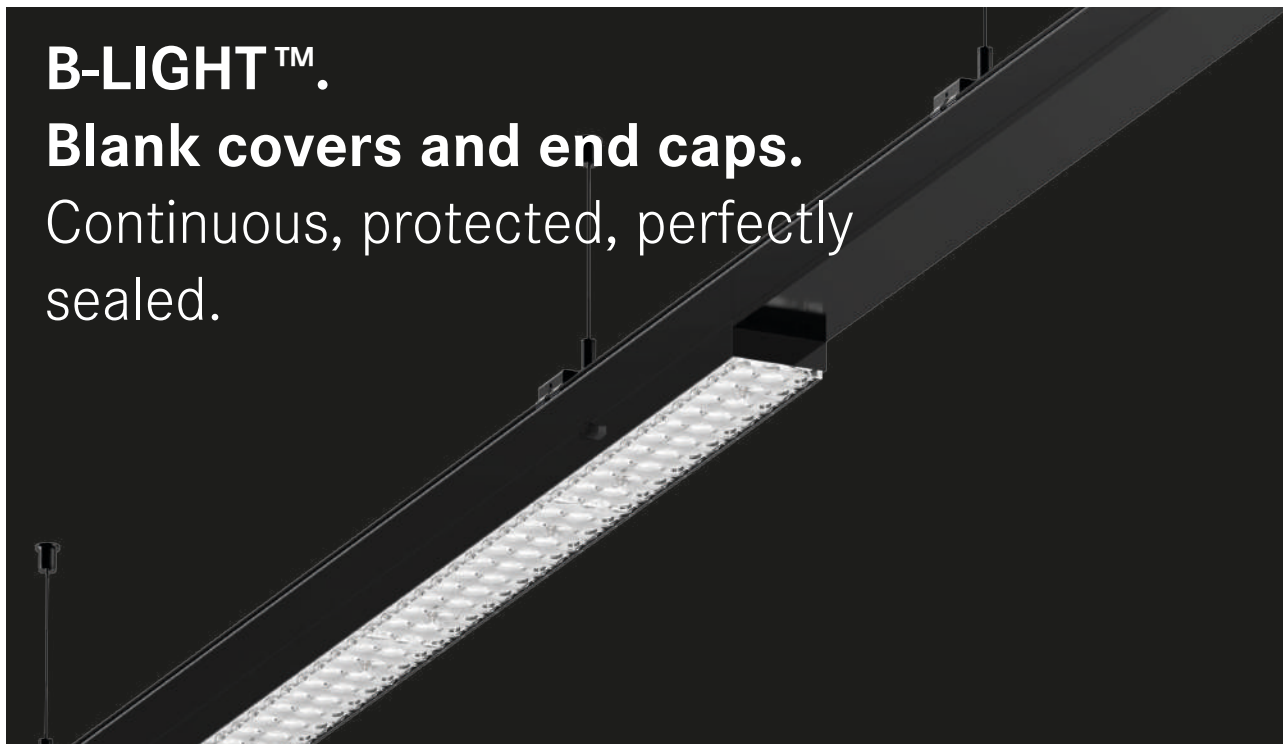

Blank cover, aluminum

Article no.	Designation	Color	Material	Length	Price in €
55170070	BBA 1438 ws AL	white	Aluminum	1,438 mm	37.00
55170080	BBA 1438 sw AL	black	Aluminum	1,438 mm	37.00

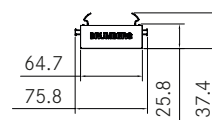

Module for sensor element, aluminum

Developed in cooperation with ESYLUX and optimally matched to models **EP1042759** and **EP10055386**. Also compatible with products from other manufacturers.

Article no.	Designation	Color	Material	Length	Price in €
55171070	BSM 1438 ws	white	Aluminum	1,438 mm	49.00
55171080	BSM 1438 sw	black	Aluminum	1,438 mm	49.00

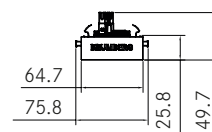

Module for track spotlights, aluminum Incl. 3-phase conductor rail, 230 V AC

Article no.	Designation	Color	Material	Length	Price in €
55172070	BST 690 ws AL	white	Aluminum	1,438 mm	139.00
55172080	BST 690 sw AL	black	Aluminum	1,438 mm	139.00

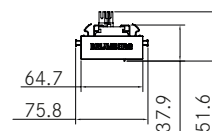

Blank cover, polycarbonate

Article no.	Designation	Color	Material	Length	Price in €
55173070	BBA 1438 ws PC	white	Polycarbonate	1,438 mm	13.00
55173080	BBA 1438 sw PC	black	Polycarbonate	1,438 mm	13.00

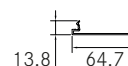

These articles are subject to discount group 3.

white = RAL 9016, black = RAL 9005

End cap, 1 pc.

Article no.	Designation	Color	Price in €
55180070	BTE ws	white	3.50
55180080	BTE sw	black	3.50

These articles are subject to discount group 3.

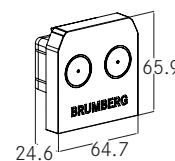

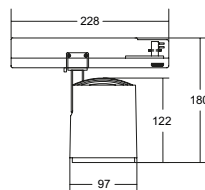

RETAIL ONE LED track spotlights

Lamp: LED, input voltage: 220-240 V AC, 50-60 Hz, output: 33.5 W, material: aluminum, delivery: incl. control gear, switchable

Service life:

L80/B50, 50,000 hours (ta: +25 °C)

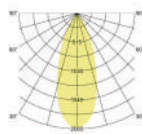

Article no. textured white	Article no. textured black	Beam angle	Color temperature	Luminous flux	Color rendering	Control	System efficiency	Price in €
88182173	88182183	20°	3,000 K	4,332 lm	CRI>90	switchable	129 lm / W	129.90
88182175	88182185	20°	3,500 K	4,319 lm	CRI>90	switchable	129 lm / W	129.90
88182174	88182184	20°	4,000 K	4,269 lm	CRI>90	switchable	127 lm / W	129.90
88183173	88183183	30°	3,000 K	4,332 lm	CRI>90	switchable	129 lm / W	129.90
88183175	88183185	30°	3,500 K	4,319 lm	CRI>90	switchable	129 lm / W	129.90
88183174	88183184	30°	4,000 K	4,269 lm	CRI>90	switchable	127 lm / W	129.90
88184173	88184183	40°	3,000 K	4,332 lm	CRI>90	switchable	129 lm / W	129.90
88184175	88184185	40°	3,500 K	4,319 lm	CRI>90	switchable	129 lm / W	129.90
88184174	88184184	40°	4,000 K	4,269 lm	CRI>90	switchable	127 lm / W	129.90
88186173	88186183	60°	3,000 K	4,332 lm	CRI>90	switchable	129 lm / W	129.90
88186175	88186185	60°	3,500 K	4,319 lm	CRI>90	switchable	129 lm / W	129.90
88186174	88186184	60°	4,000 K	4,269 lm	CRI>90	switchable	127 lm / W	129.90



These articles are subject to discount group 1.





5-year lighting guarantee

The BRUMBERG quality promise.

5-year lighting guarantee.

Brumberg luminaires fulfill the highest standards of material and manufacturing quality. That is something we guarantee with the Brumberg quality promise. The lighting guarantee represents an upgrade to the statutory two-year warranty period.

Unrestricted product confidence in our luminaire systems and control gear forms the basis for the lighting guarantee. Whenever you buy a Brumberg product we guarantee, within the framework of the warranty conditions, its perfect quality and function over the period of 5 years.

The lighting guarantee is completely free of charge and applies to our trade partners.

The five-year guarantee is only valid after registration on our website.

www.brumberg.com/de/5-jahre-garantie



BRUMBERG

BRUMBERG Leuchten GmbH & Co. KG
Hellefelder Str. 63 | 59846 Sundern (Germany)
Phone: +49 (0) 29 34 / 96 11 0 | Fax: +49 (0) 29 34 / 96 11 96
info@brumberg.com | www.brumberg.com

PREMIUM | **MARKEN** Partner 

BRUMBERG products are available exclusively from your electrical subcontractor. According to DIN VDE 0100 electrical equipment may only be installed by a qualified electrician.



Resource-efficient management. We're in.



ÖKOPROFIT
Soest-Sauerland