

BRUMBERG

Light.
For generations.

Light | 2022



Light 2022. Connecting people and spaces.

With a strong focus on projects and the range of luminaires required for them, we are your partner for every construction project, from private properties and shops, stores to office or hotel complexes. For this purpose, we have included important new products in our range of services. For example, our moisture-proof luminaires of the HUMID series, the SOL Highbay LED downlights or our escape sign luminaires are entirely new additions. With this expansion of our product range, we are sustainably increasing our project compatibility. We are also developing individually configurable luminaires and luminaire systems. After all, light is always also a design element, emphasizing and setting the stage for architecture, supporting various activities, and connecting people and spaces.

Optimized layout and simplified product range structure.

We are also constantly developing the presentation of our products. For example, we have recategorized our product range structure so that you can find what you are looking for as quickly as possible. Thanks to a simplified sorting, the catalog is clearer and easier to handle. With various helpful QR codes that lead you to in-depth information on our website, we are building a bridge between analog and digital. This is how we ensure optimal information transfer.

Brumberg in transition.

Two turbulent, challenging years lie behind us since the last Brumberg main catalog. The historic coronavirus pandemic has presented us with unprecedented challenges. We rolled up our sleeves, broke new ground, and innovated: From

the Brumberg Media Library with product videos and on-demand training, to digital trade shows and the relaunch of our website, we have primarily expanded our online services. We have maintained close personal contact with our customers and partners despite restrictions with the patented Brumberg trunk training courses. This cooperative collaboration is what makes our network so special – we are proud of this and we thank you for your loyalty.

We are Brumberg.

Despite all the change, one thing remains the same: In our company, people make the difference. Our employees as well as our cooperation partners in the market are like one big family to us. Their commitment is our most important building block for entrepreneurial success. "We are Brumberg" is more than just a claim, it is our attitude and our firm standpoint, because together we master every challenge. We would like to thank our team for their outstanding performance and their special commitment to our company – this is certainly unique in the industry.

Enjoy the new Brumberg main catalog "LIGHT 2022".

Johannes Brumberg

Benedikt Brumberg

1

Interior lighting

Light. That connects people and spaces.

Thanks to our well thought-out luminaires and lighting concepts, we create living and working spaces in which people feel comfortable. In doing so, we attach great importance to functional diversity, state-of-the-art technology and energy efficiency. With this approach, we provide the right lighting solution for every room.



01 Recessed luminaires (ceiling)

02 Surface-mounted luminaires (ceiling)

03 Pendant luminaires

04 Wall-mounted luminaires

05 Track spotlights

06 Light channel systems

07 LED flex boards

08 Table lamps, floor lamps and floor luminaires

09 Moisture-proof luminaires

10 Downlights

11 Fiber technology

12 Rescue sign luminaires

2 Exterior lighting

Light.

To accompany people through the night.

We offer versatile, adaptable lighting tools for outdoor areas to adapt outdoor spaces to people's specific requirements. Buildings become focal points, rows of trees take on a guiding function – thus creating feel-good zones.

3 LED modules and accessories

Always the right complementary parts.

With our LED modules, you can retrofit existing luminaires or put together numerous luminaire series such as Steam or the M1 module system to suit the customers' requirements. In our product range, you will find the appropriate power supplies for each luminaire. We also offer the right control units for every requirement, so that the illumination can always be adapted to individual customer needs. If you need further accessories, we have numerous supplements and accessories for you, such as reducing rings.



446
Recessed
luminaires

460
Surface-mounted
luminaires

13 Ceiling-mounted luminaires

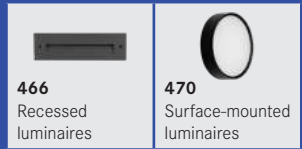

466
Recessed
luminaires

470
Surface-mounted
luminaires

14 Wall-mounted luminaires



480
Ground recessed
luminaires

492
Ground
spikes

15 Floor luminaires



496
Bollards

16 Bollard luminaires

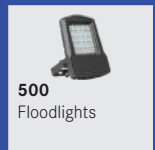

500
Floodlights

17 Floodlights



504
MR16
LED modules

18 LED modules



512
Converter

530
Power supplies

536
Controllers

19 Operating technology



554
Holders /
accessories

556
Reduction
rings

561
Mounting
springs / circlips

20 Mounting technology

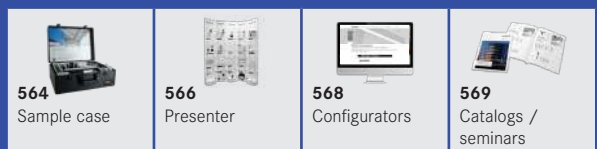

564
Sample case

566
Presenter

568
Configurators

569
Catalogs /
seminars

21 Sales support

<p>BRUMBERG</p> <p>570 About Brumberg</p>	 <p>574 Index</p>	 <p>592 General Business Conditions</p>	 <p>594 M1 matrix</p>	 <p>596 Color codes</p>	 <p>597 Pictograms / Pro- tection classes</p>
---	---	---	---	---	--

Appendix

1 Interior lighting



01 Ceiling-mounted recessed luminaires. Illumination for every field of application.

Downlights (rigid)	Page 10	Luminaires with higher protection class	Page 112
Spotlights (LED + LV + HV)	Page 24	Panels	Page 140
Recessed spotlights and Wallwasher	Page 80	Light points	Page 148
COUPLED module system	Page 90	Luminaires with low installation depth	Page 152
Module system M1	Page 94		



Private house, Coesfeld

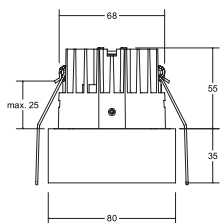

IMPLEMENT LED recessed downlight

Illuminants: LED, color rendering: CRI > 90, power: 8.9 W, beam angle: 37°, material: Aluminum / Plastic

You will find the corresponding 500-mA converter on page 522.

You will find the surface-mounted versions on page 169.

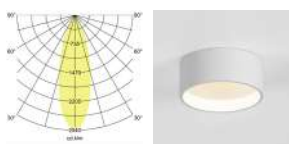

Accessories: Mounting ring for recessed installation DA = 88 mm, item no. 81091170, price: € 14.40

Item no.	Color	Luminous flux	Color temperature	Price €
12391173	Structural white	730 lm	3000 K	83.70

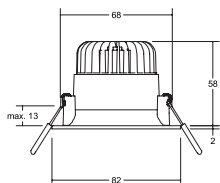

LED recessed downlight

Illuminants: LED, model: Plug&Play, color rendering: CRI > 80, power: 7 W, beam angle: 40°, material: Aluminum / Plastic

You will find the corresponding 350-mA converters from page 516 onwards.

You will find suitable recessed spotlights on page 33.

Item no.	Color	Luminous flux	Color temperature	Price €
12384173	Structural white	600 lm	3000 K	38.60
12384683	Structural silver	600 lm	3000 K	38.60



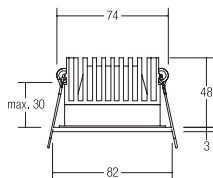

LED recessed downlight, dim2warm

If the luminaire is dimmed, the color temperature reduces.
 Illuminants: LED, model: Plug&Play, color rendering: CRI > 90, power: 12 W, beam angle: 24°, material: Aluminum / Plastic

You will find the corresponding 350-mA converters from page 516 onwards.

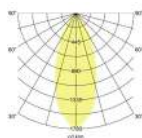

Item no.	Color	Luminous flux	Color temperature	Price €
12116073	White	930 lm	3000 K - 1800 K	102.10

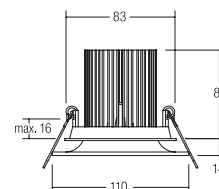
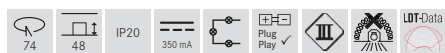

LED recessed downlight, with indirect component

Luminaire with direct and indirect light component.
 Illuminants: LED, model: Plug&Play, color rendering: CRI > 80, power: 10.5 W, beam angle: 34°, material: Aluminum / Glass

You will find the corresponding 350-mA converters from page 516 onwards.

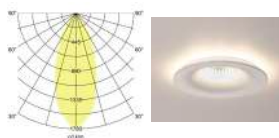

Item no.	Color	Luminous flux	Color temperature	Price €
12406073	White	887 lm	3000 K	137.80



LED recessed downlight set, dim2warm, dimmable phase section

If the luminaire is dimmed, the color temperature reduces.
 Set including converter for 230 V mains voltage, dimmable phase section, dimensions of converter: L 125 x W 51 x H 20 mm
 Illuminants: LED, color rendering: CRI > 90, power: 12 W, beam angle: 24°, material: Aluminum / Plastic

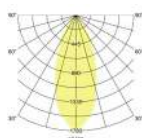

Item no.	Color	Luminous flux	Color temperature	Price €
39116073	White	930 lm	3000 K - 1800 K	142.20

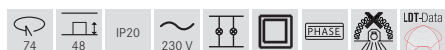

NEW

LED recessed downlight set, with indirect component, dimmable phase section

Luminaire with direct and indirect light component.
 Set including converter for 230 V mains voltage, dimmable phase section, dimensions of converter: L 125 x W 51 x H 20 mm.
 Illuminants: LED, color rendering: CRI > 80, power: 10.5 W, beam angle: 34°, material: Aluminum / Glass / Plastic

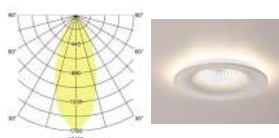

Item no.	Color	Luminous flux	Color temperature	Price €
39406073	NEW White	887 lm	3000 K	177.90



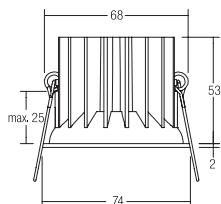

CIRCLE LED recessed downlight, with circumferential light joint

Illuminants: LED, model: Plug&Play, color rendering: CRI > 90, power: 6.1 W, beam angle: 50°, material: Aluminum / Plastic

You will find the corresponding 350-mA converters from page 516 onwards.

You will find suitable surface-mounted luminaires on page 178.



Item no.	Color	Luminous flux	Color temperature	Price €
12415173	Structural white	680 lm	3000 K	53.00

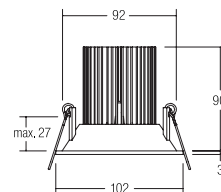

CIRCLE LED recessed downlight, with circumferential light joint

Illuminants: LED, model: Plug&Play, color rendering: CRI > 80, power: 13.6 W, beam angle: 45°, material: Aluminum

You will find the corresponding 700-mA converters from page 524 onwards.

You will find suitable surface-mounted luminaires on page 178.



Item no.	Color	Luminous flux	Color temperature	Price €
12407073	White	950 lm	3000 K	97.80

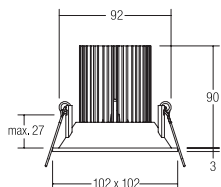

CIRCLE LED recessed downlight, with circumferential light joint

Illuminants: LED, model: Plug&Play, color rendering: CRI > 80, power: 13.6 W, beam angle: 45°, material: Aluminum

You will find the corresponding 700-mA converters from page 524 onwards.

You will find suitable surface-mounted luminaires on page 178.



Item no.	Color	Luminous flux	Color temperature	Price €
12408073	White	950 lm	3000 K	97.80

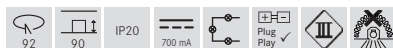

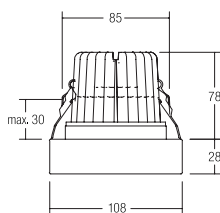

KEGON LED recessed downlight

Illuminants: LED, model: Plug&Play, color rendering: CRI > 90, power: 13 W, beam angle: 36°, material: Aluminum / Acrylic

You will find the corresponding 350-mA converters from page 516 onwards.

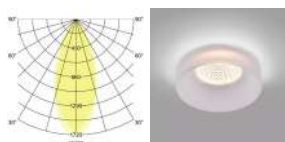

Item no.	Color	Luminous flux	Color temperature	Price €
12225003	Satined	950 lm	3000 K	103.70

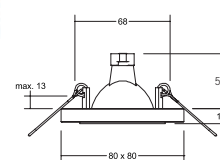
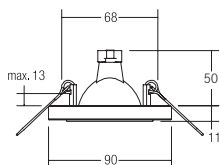
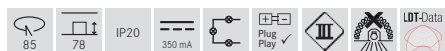

Recessed downlight, GX5.3

Illuminants: For LED retrofit lamp, model: GX5.3, power: maximum 50 W, material: Aluminum cast / glass

Recessed downlight, GX5.3

Illuminants: For LED retrofit lamp, model: GX5.3, power: maximum 50 W, material: Aluminum cast / glass

Item no.	Color	Price €
0282.00	Chromium	21.50



Item no.	Color	Price €
0283.00	Chromium	27.20



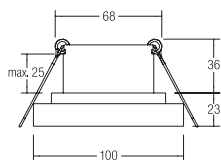

reddot award 2019
winner

TUBIC LED recessed downlight, with indirect component

LED recessed ceiling downlight with indirect light component. Direct luminous flux 830 lm, indirect luminous flux 130 lm.

Illuminants: LED, model: Plug&Play, color rendering: CRI > 90, power: direct 9.5 W / indirect 1.5 W, beam angle: 40°, material: Aluminum / Plastic

You will find the corresponding 350-mA converters from page 516 onwards.

You will find suitable ceiling and wall-mounted luminaires on pages 39, 165 and 224.

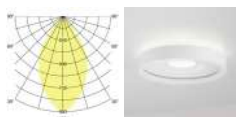

Item no.	Color	Luminous flux	Color temperature	Price €
12226173	Structural white	858 lm	3000 K	91,20

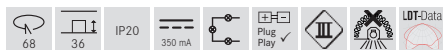

Design: Alexander Grimm (Lounge Design)
Idea: Michael Ruschmann (Lichtraum Ruschmann Stein GmbH)

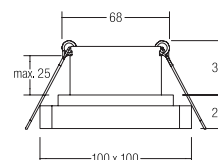

QUBIC LED recessed downlight, with indirect component

LED recessed ceiling downlight with indirect light component. Direct luminous flux 830 lm, indirect luminous flux 130 lm.

Illuminants: LED, model: Plug&Play, color rendering: CRI > 90, power: direct 9.5 W / indirect 1.5 W, beam angle: 40°, material: Aluminum / Plastic

You will find the corresponding 350-mA converters from page 516 onwards.

You will find suitable ceiling and wall-mounted luminaires on pages 39, 165 and 224.

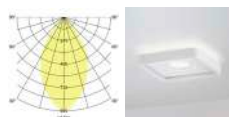

Item no.	Color	Luminous flux	Color temperature	Price €
12227173	Structural white	858 lm	3000 K	95,60

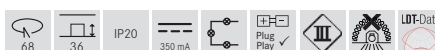

Design: Lounge Design (Alexander Grimm and Ronny Eysser)
Idea: Lichtraum Ruschmann Stein GmbH (Michael Ruschmann)

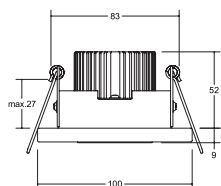

KONKRET LED recessed downlight

Illuminants: LED, model: Plug&Play, color rendering: CRI > 90, power: 6.8 W, beam angle: 40°, material: Concrete / aluminum / plastic

You will find the corresponding 350-mA converters from page 516 onwards.

You will find suitable pendant and wall-mounted luminaires on pages 201 and 227.

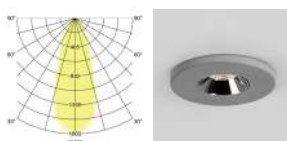

Item no.	Color	Luminous flux	Color temperature	Price €
12114733	Concrete / Chromium	520 lm	3000 K	84.50

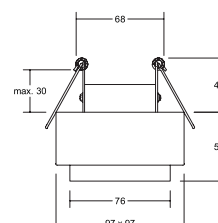

KONKRET LED recessed downlight

Illuminants: LED, model: Plug&Play, color rendering: CRI > 90, power: 6.8 W, beam angle: 40°, material: Concrete / Aluminum / Plastic

You will find the corresponding 350-mA converters from page 516 onwards.

You will find suitable pendant and wall-mounted luminaires on pages 201 and 227.

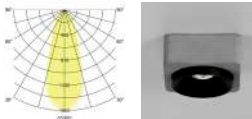

Item no.	Color	Luminous flux	Color temperature	Price €
12219733	Concrete / structural black	520 lm	3000 K	111.00



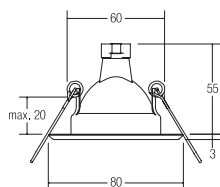

Recessed downlight, GX5.3

Illuminants: For LED retrofit lamp, model: GX5.3, power: maximum 50 W, material: Stainless steel

Item no.	Color	Price €
2190.07	White	23.80
2190.20	Clear powder-coated stainless steel	23.80
2190.22	Stainless steel	21.40

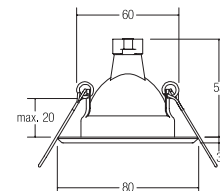
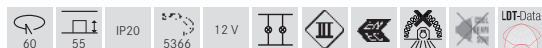

Recessed downlight, GX5.3

Illuminants: For LED retrofit lamp, model: GX5.3, power: maximum 50 W, material: Steel

Item no.	Color	Price €
2017.02	Chromium	12.50
2017.03	Chromium matte	17.90
2017.07	White	11.50

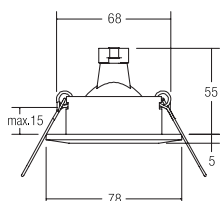
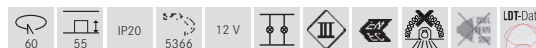

Recessed downlight, GX5.3

Illuminants: For LED retrofit lamp, model: GX5.3, power: maximum 50 W, material: Aluminum cast

Item no.	Color	Price €
2117.02	Chromium	11.00
2117.03	Chromium matte	13.40
2117.07	White	9.70

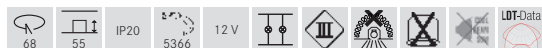

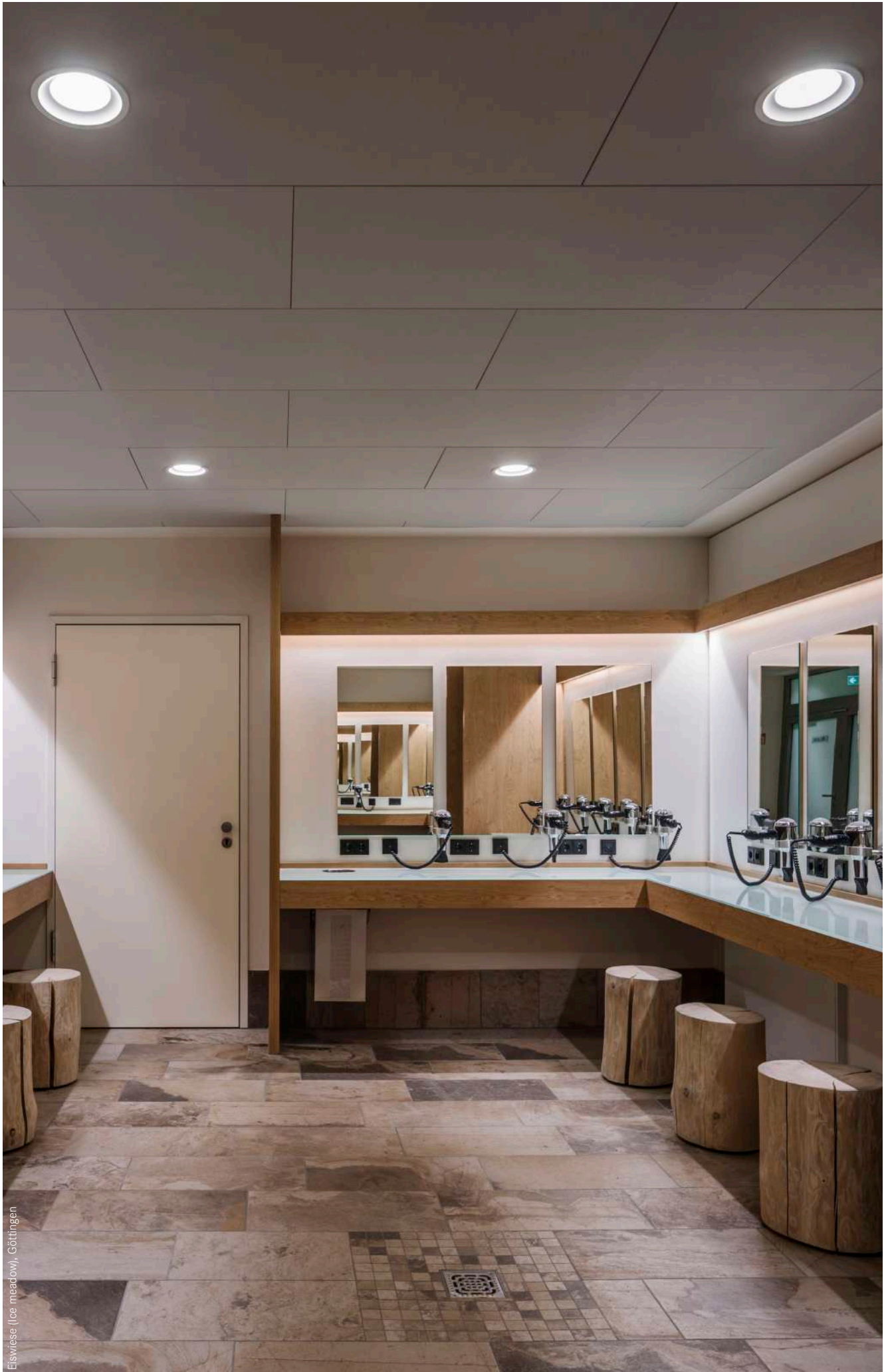

Eiswiese (lee meadow), Göttingen



LED recessed downlight, TunableWhite

Illuminants: LED, color rendering: CRI > 80, power: 7 W, beam angle: 120°, material: Aluminum / Plastic

You will find corresponding 24 V power supplies from page 532 onwards and corresponding controllers from page 536 onwards.

Item no.	Color	Luminous flux	Color temperature	Price €
12423074	White	460 lm (4000 K)	2700 K - 6000 K	96.60

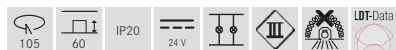

* The specified power of 7 W is per control channel, the specified luminous flux for the complete luminaire.



LED recessed downlight, TunableWhite

Illuminants: LED, color rendering: CRI > 80, power: 11 * W, beam angle: 120°, material: Aluminum / Plastic

You will find corresponding 24 V power supplies from page 532 onwards and corresponding controllers from page 536 onwards.

Item no.	Color	Luminous flux	Color temperature	Price €
12424074	White	730 lm (4000 K)	2700 K - 6000 K	122.50



* The specified power of 11 W is per control channel, the specified luminous flux for the complete luminaire.



LED recessed downlight, TunableWhite

Illuminants: LED, color rendering: CRI > 80, power: 15* W, beam angle: 120°, material: Aluminum / Plastic

You will find corresponding 24 V power supplies from page 532 onwards and corresponding controllers from page 536 onwards.

Item no.	Color	Luminous flux	Color temperature	Price €
12425074	White	980 lm (4000 K)	2700 K - 6000 K	160.90

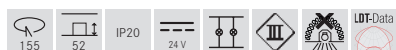

* The specified power of 15 W is per control channel, the specified luminous flux for the complete luminaire.

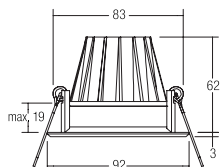

BOWL LED recessed downlight

Illuminants: LED, model: Plug&Play, color rendering: CRI > 80, power: 7 W, beam angle: 30°, material: Aluminum / Glass

You will find the corresponding 700-mA converters from page 524 onwards.

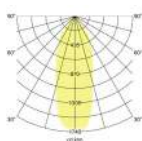

Item no.	Color	Luminous flux	Color temperature	Price €
12520073	White	630 lm	3000 K	47.50
12520074	White	660 lm	4000 K	47.50

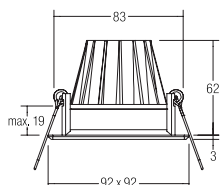
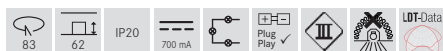

BOWL LED recessed downlight

Illuminants: LED, model: Plug&Play, color rendering: CRI > 80, power: 7 W, beam angle: 30°, material: Aluminum / Glass

You will find the corresponding 700-mA converters from page 524 onwards.

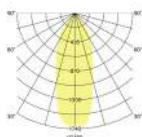

Item no.	Color	Luminous flux	Color temperature	Price €
12530073	White	630 lm	3000 K	48.50
12530074	White	660 lm	4000 K	48.50

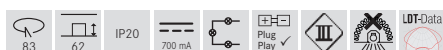

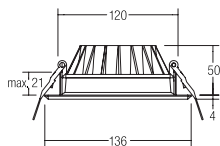

BOWL LED recessed downlight

Illuminants: LED, model: Plug&Play, color rendering: CRI > 80, power: 12 W, beam angle: 95°, material: Aluminum / PMMA

You will find the corresponding 350-mA converters from page 516 onwards.

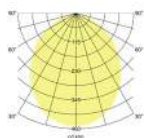

Item no.	Color	Luminous flux	Color temperature	Price €
12527073	White	960 lm	3000 K	49.60
12527074	White	1,010 lm	4000 K	49.60

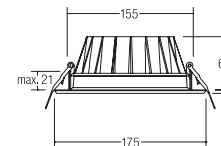
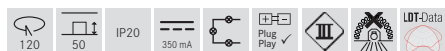

BOWL LED recessed downlight

Illuminants: LED, color rendering: CRI > 80, power: 20 W, beam angle: 93°, material: Aluminum / PMMA

You will find the corresponding 500-mA converter on page 522.

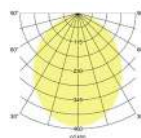

Item no.	Color	Luminous flux	Color temperature	Price €
12528073	White	1,630 lm	3000 K	67.90
12528074	White	1,720 lm	4000 K	67.90

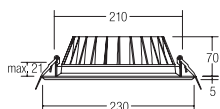

BOWL LED recessed downlight

Illuminants: LED, model: Plug&Play, color rendering: CRI > 80, power: 30 W, beam angle: 97°, material: Aluminum / PMMA

You will find the corresponding 700-mA converters from page 524 onwards.

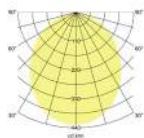

Item no.	Color	Luminous flux	Color temperature	Price €
12529073	White	2,500 lm	3000 K	98.40
12529074	White	2,620 lm	4000 K	98.40

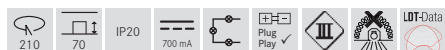



LED recessed downlight

NEU

Illuminants: LED, glare rating: UGR < 22, power: 11 W, beam angle: 65°, material: Aluminum / Plastic/ Steel, including converter for connection with 230 V mains voltage

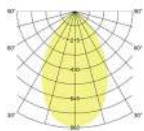

Item no.	Color	Color rendering	Color temperature	Luminous flux	Control	Price €
12560173	NEW Structural white	CRI > 90	3000 K	801 lm	Switchable	79.00
12560174	NEW Structural white	CRI > 90	4000 K	850 lm	Switchable	79.00
12562173	NEW Structural white	CRI > 90	3000 K	801 lm	DALI	129.00
12562174	NEW Structural white	CRI > 90	4000 K	850 lm	DALI	129.00
12560183	NEW Structural black	CRI > 90	3000 K	801 lm	Switchable	79.00
12560184	NEW Structural black	CRI > 90	4000 K	850 lm	Switchable	79.00
12562183	NEW Structural black	CRI > 90	3000 K	801 lm	DALI	129.00
12562184	NEW Structural black	CRI > 90	4000 K	850 lm	DALI	129.00

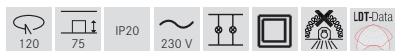

These items are subject to discount group 2.



LED recessed downlight

NEU

Illuminants: LED, glare rating: UGR < 22, power: 19 W, beam angle: 68°, material: Aluminum / Plastic/ Steel, including converter for connection with 230 V mains voltage

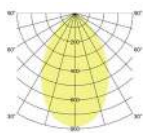

Item no.	Color	Color rendering	Color temperature	Luminous flux	Control	Price €
12570173	NEW Structural white	CRI > 90	3000 K	1,235 lm	Switchable	99.00
12570174	NEW Structural white	CRI > 90	4000 K	1,310 lm	Switchable	99.00
12572173	NEW Structural white	CRI > 90	3000 K	1,235 lm	DALI	139.00
12572174	NEW Structural white	CRI > 90	4000 K	1,310 lm	DALI	139.00
12570183	NEW Structural black	CRI > 90	3000 K	1,235 lm	Switchable	99.00
12570184	NEW Structural black	CRI > 90	4000 K	1,310 lm	Switchable	99.00
12572183	NEW Structural black	CRI > 90	3000 K	1,235 lm	DALI	139.00
12572184	NEW Structural black	CRI > 90	4000 K	1,310 lm	DALI	139.00



These items are subject to discount group 2.

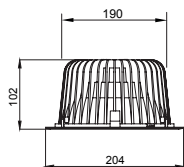

LED recessed downlight



Illuminants: LED, glare rating: UGR < 22, power: 25 W, beam angle: 74°, material: Aluminum / Plastic/ Steel, including converter for connection with 230 V mains voltage

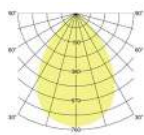

Item no.	Color	Color rendering	Color temperature	Luminous flux	Control	Price €
12550173	NEW Structural white	CRI > 90	3000 K	1,877 lm	Switchable	129.00
12550174	NEW Structural white	CRI > 90	4000 K	1,962 lm	Switchable	129.00
12552173	NEW Structural white	CRI > 90	3000 K	1,877 lm	DALI	199.00
12552174	NEW Structural white	CRI > 90	4000 K	1,962 lm	DALI	199.00
12550183	NEW Structural black	CRI > 90	3000 K	1,877 lm	Switchable	129.00
12550184	NEW Structural black	CRI > 90	4000 K	1,962 lm	Switchable	129.00
12552183	NEW Structural black	CRI > 90	3000 K	1,877 lm	DALI	199.00
12552184	NEW Structural black	CRI > 90	4000 K	1,962 lm	DALI	199.00



These items are subject to discount group 2.

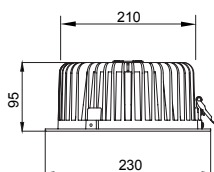

LED recessed downlight



Illuminants: LED, glare rating: UGR < 22, power: 32.5 W, beam angle: 70°, material: Aluminum / Plastic/ Steel, including converter for connection with 230 V mains voltage

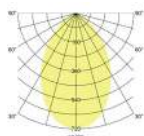

Item no.	Color	Color rendering	Color temperature	Luminous flux	Control	Price €
12551173	NEW Structural white	CRI > 90	3000 K	2,600 lm	Switchable	169.00
12551174	NEW Structural white	CRI > 90	4000 K	2,720 lm	Switchable	169.00
12553173	NEW Structural white	CRI > 90	3000 K	2,600 lm	DALI	239.00
12553174	NEW Structural white	CRI > 90	4000 K	2,720 lm	DALI	239.00
12551183	NEW Structural black	CRI > 90	3000 K	2,600 lm	Switchable	169.00
12551184	NEW Structural black	CRI > 90	4000 K	2,720 lm	Switchable	169.00
12553183	NEW Structural black	CRI > 90	3000 K	2,600 lm	DALI	239.00
12553184	NEW Structural black	CRI > 90	4000 K	2,720 lm	DALI	239.00



These items are subject to discount group 2.

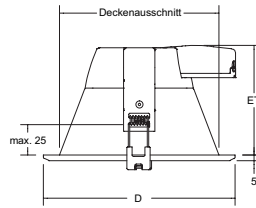

LED recessed downlight, IP44

NEW

Simple and tool-free mounting. Through-wiring is possible by using a plug-in terminal. Installation in various types of ceilings with thicknesses from 2 to 20 mm is possible.

Illuminants: LED, Color rendering: CRI > 80, beam angle: 100°, material: Aluminum / Plastic/ Steel, including converter for connection with 230 V mains voltage

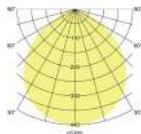

Item no.	Color	Power	Color temperature	Luminous flux	UGR	Ceiling cut-outs	Diameter x installation depth	Price €
12540073	NEW White	12 W	3000 K	1,200 lm	< 22	150 mm	167 x 100 mm	77.00
12540074	NEW White	12 W	4000 K	1,200 lm	< 22	150 mm	167 x 100 mm	77.00
12541073	NEW White	21 W	3000 K	2,100 lm	< 26	200 mm	217 x 110 mm	89.00
12541074	NEW White	21 W	4000 K	2,100 lm	< 26	200 mm	217 x 110 mm	89.00

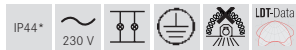

* IP44 when installed in closed ceilings

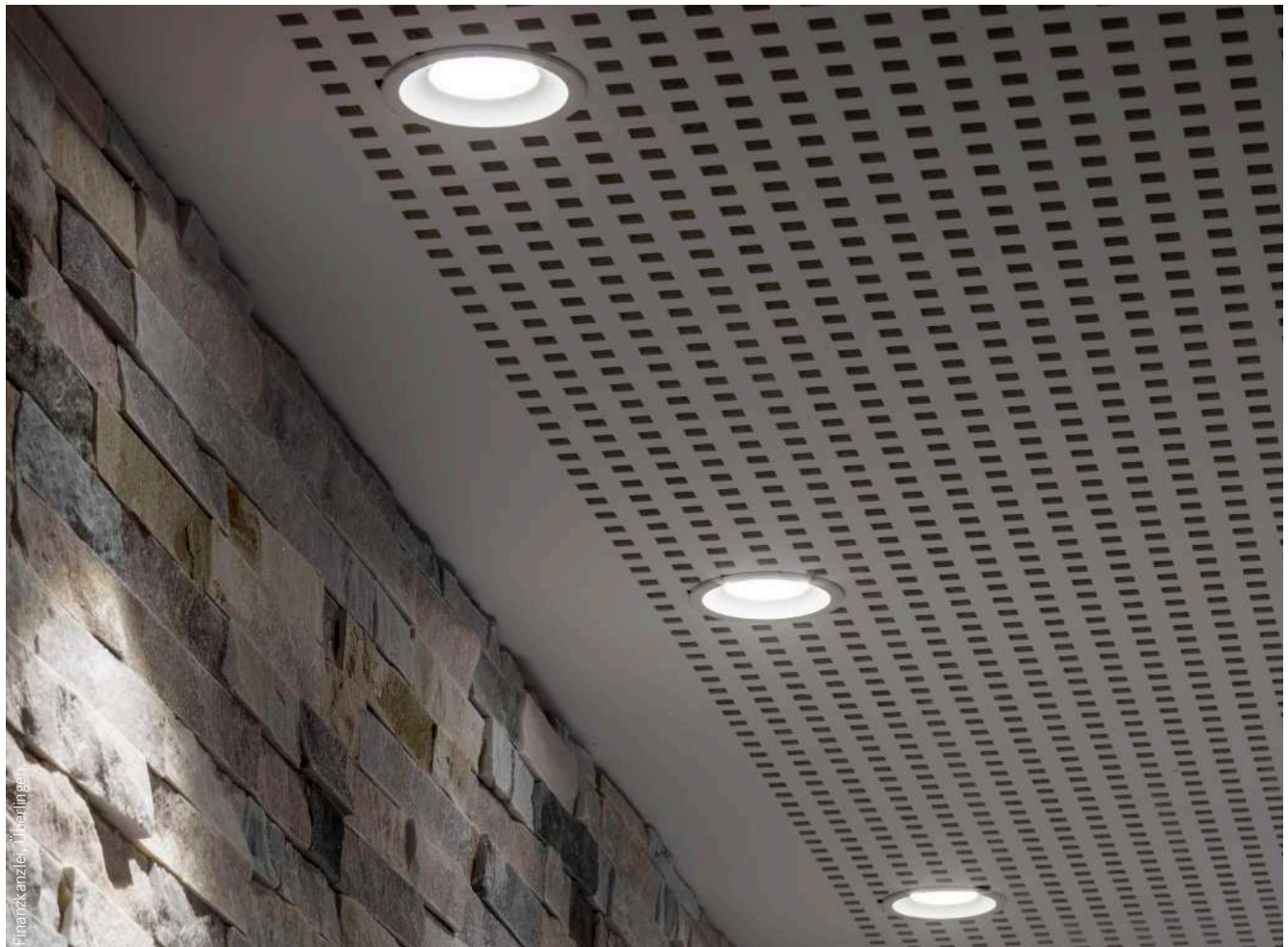

Finanzkanzlei, Überlingen

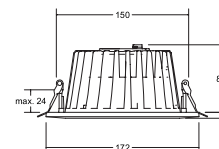
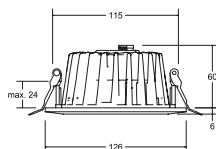

LED recessed downlight

NEW

Illuminants: LED, color rendering: CRI > 80, glare rating: UGR < 19, power: 20 W, beam angle: 40°, material: Aluminum / Glass / Plastic, delivery: including converter for connection with 230 V mains voltage and connection box

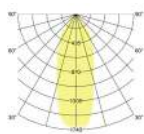

Item no.	Color	Luminous flux	Color temperature	Control	Price €
41542073	NEW White	1,380 lm	3000 K	Switchable	83.70
41542074	NEW White	1,470 lm	4000 K	Switchable	83.70
41552073	NEW White	1,380 lm	3000 K	DALI	103.20
41552074	NEW White	1,470 lm	4000 K	DALI	103.20

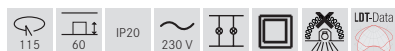

These items are subject to discount group 2.

LED recessed downlight

NEW

Illuminants: LED, color rendering: CRI > 80, glare rating: UGR < 19, power: 30 W, beam angle: 40°, material: Aluminum / Glass / Plastic, delivery: including converter for connection with 230 V mains voltage and connection box

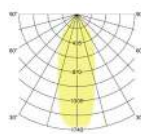

Item no.	Color	Luminous flux	Color temperature	Control	Price €
41543073	NEW White	2,300 lm	3000 K	Switchable	102.20
41543074	NEW White	2,400 lm	4000 K	Switchable	102.20
41553073	NEW White	2,300 lm	3000 K	DALI	121.70
41553074	NEW White	2,400 lm	4000 K	DALI	121.70



These items are subject to discount group 2.

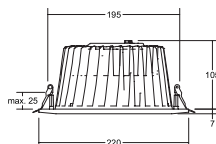

LED recessed downlight

NEW

Illuminants: LED, color rendering: CRI > 80, glare rating: UGR < 19, power: 36.3 W, beam angle: 45°, material: Aluminum / Glass / Plastic, delivery: including converter for connection with 230 V mains voltage and connection box

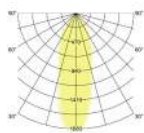

Item no.	Color	Luminous flux	Color temperature	Control	Price €
41544073	NEW White	3,650 lm	3000 K	Switchable	134.30
41544074	NEW White	4,000 lm	4000 K	Switchable	134.30
41554073	NEW White	3,650 lm	3000 K	DALI	153.60
41554074	NEW White	4,000 lm	4000 K	DALI	153.60



These items are subject to discount group 2.

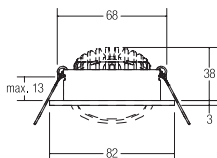

Color variants.

Numerous options for different furnishing highlights: Set the accents.

LED recessed spotlight

Illuminants: LED, model: Plug&Play, color rendering: CRI > 80, power: 7 W, beam angle: 38°, material: Aluminum / Polycarbonate

You will find the corresponding 350-mA converters from page 516 onwards.

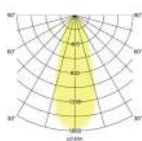

Item no.	Color	Luminous flux	Color temperature	Price €
12261023	Chromium	740 lm	2700 K	50.80
12361023	Chromium	740 lm	3000 K	50.80
12261073	White	740 lm	2700 K	49.80
12361073	White	740 lm	3000 K	49.80
12361074	White	770 lm	4000 K	49.80
12261083	Black	740 lm	2700 K	49.80
12361083	Black	740 lm	3000 K	49.80
12361084	Black	770 lm	4000 K	49.80
12261253	Aluminum matte	740 lm	2700 K	54.00
12361253	Aluminum matte	740 lm	3000 K	54.00
12361254	Aluminum matte	770 lm	4000 K	54.00
12261633	Champagne matte	740 lm	2700 K	59.30
12361633	Champagne matte	740 lm	3000 K	59.30
12261643	Titanium matte	740 lm	2700 K	59.30
12361643	Titanium matte	740 lm	3000 K	59.30

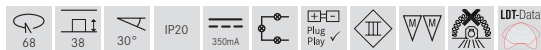

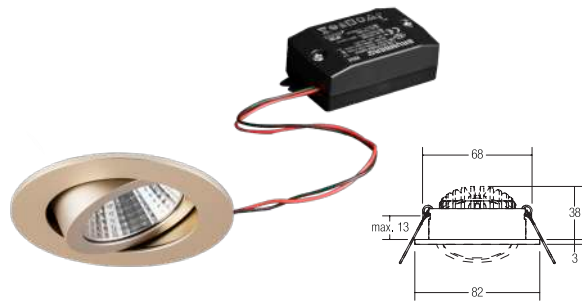

LED recessed spotlight set, switchable

Set including converter for 230 V mains voltage, switchable, dimensions of converter: L 68 x W 35 x H 21 mm

Illuminants: LED, color rendering: CRI > 80, power: 7 W, beam angle: 38°, material: Aluminum / Polycarbonate

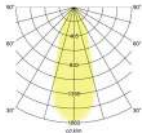

Item no.	Color	Luminous flux	Color temperature	Price €
38261023	Chromium	740 lm	2700 K	74.30
38361023	Chromium	740 lm	3000 K	74.30
38261073	White	740 lm	2700 K	73.30
38361073	White	740 lm	3000 K	73.30
38361074	White	770 lm	4000 K	73.30
38261083	Black	740 lm	2700 K	73.30
38361083	Black	740 lm	3000 K	73.30
38361084	Black	770 lm	4000 K	73.30
38261253	Aluminum matte	740 lm	2700 K	77.50
38361253	Aluminum matte	740 lm	3000 K	77.50
38361254	Aluminum matte	770 lm	4000 K	77.50
38261633	Champagne matte	740 lm	2700 K	82.80
38361633	Champagne matte	740 lm	3000 K	82.80
38261643	Titanium matte	740 lm	2700 K	82.80
38361643	Titanium matte	740 lm	3000 K	82.80

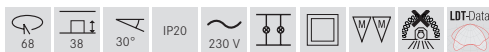

MM sign of the luminaire included in the set.

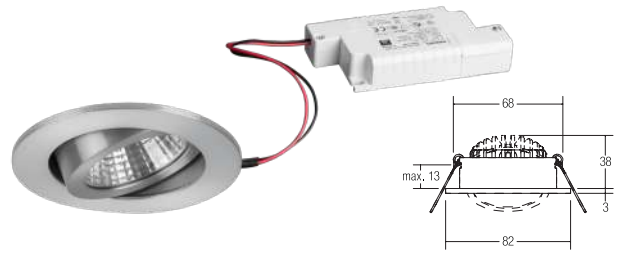

LED recessed spotlight set, dimmable phase section

Set including converter for 230 V mains voltage, dimmable phase section, dimensions of converter: L 110 x W 50 x H 19 mm

Illuminants: LED, color rendering: CRI > 80, power: 7 W, beam angle: 38°, material: Aluminum / Polycarbonate

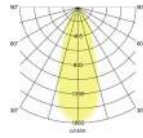

Item no.	Color	Luminous flux	Color temperature	Price €
39261023	Chromium	740 lm	2700 K	78.20
39361023	Chromium	740 lm	3000 K	78.20
39261073	White	740 lm	2700 K	77.20
39361073	White	740 lm	3000 K	77.20
39361074	White	770 lm	4000 K	77.20
39261083	Black	740 lm	2700 K	77.20
39361083	Black	740 lm	3000 K	77.20
39361084	Black	770 lm	4000 K	77.20
39261253	Aluminum matte	740 lm	2700 K	81.40
39361253	Aluminum matte	740 lm	3000 K	81.40
39361254	Aluminum matte	770 lm	4000 K	81.40
39261633	Champagne matte	740 lm	2700 K	86.70
39361633	Champagne matte	740 lm	3000 K	86.70
39261643	Titanium matte	740 lm	2700 K	86.70
39361643	Titanium matte	740 lm	3000 K	86.70

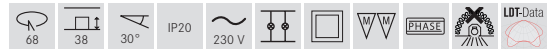

MM sign of the luminaire included in the set.

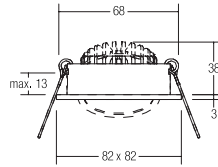

Color variants.

Numerous options for different furnishing highlights: Set the accents.

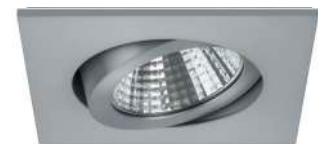
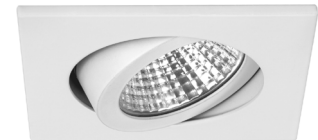

LED recessed spotlight

NEW

Illuminants: LED, model: Plug&Play, color rendering: CRI > 80, power: 7 W, beam angle: 38°, material: Aluminum / Polycarbonate

You will find the corresponding 350-mA converters from page 516 onwards.

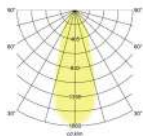

Item no.	Color	Luminous flux	Color temperature	Price €
12262023	Chromium	740 lm	2700 K	54.00
12362023	Chromium	740 lm	3000 K	54.00
12262073	White	740 lm	2700 K	53.00
12362073	White	740 lm	3000 K	53.00
12262083	NEW Black	740 lm	2700 K	53.00
12362083	NEW Black	740 lm	3000 K	53.00
12262253	Aluminum matte	740 lm	2700 K	57.20
12362253	Aluminum matte	740 lm	3000 K	57.20
12262633	Champagne matte	740 lm	2700 K	62.50
12362633	Champagne matte	740 lm	3000 K	62.50
12262643	Titanium matte	740 lm	2700 K	62.50
12362643	Titanium matte	740 lm	3000 K	62.50

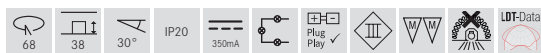

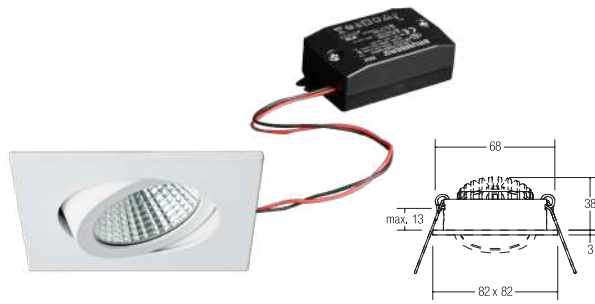

LED recessed spotlight set, switchable

NEW

Set including converter for 230 V mains voltage, switchable, dimensions of converter: L 68 x W 35 x H 21 mm

Illuminants: LED, color rendering: CRI > 80, power: 7 W, beam angle: 38°, material: Aluminum / Polycarbonate

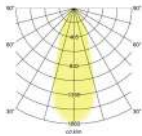

Item no.	Color	Luminous flux	Color temperature	Price €
38262023	Chromium	740 lm	2700 K	77.50
38364023	Chromium	740 lm	3000 K	77.50
38262073	White	740 lm	2700 K	76.50
38364073	White	740 lm	3000 K	76.50
38262083	NEW Black	740 lm	2700 K	76.50
38364083	NEW Black	740 lm	3000 K	76.50
38262253	Aluminum matte	740 lm	2700 K	80.70
38364253	Aluminum matte	740 lm	3000 K	80.70
38262633	Champagne matte	740 lm	2700 K	86.00
38364633	Champagne matte	740 lm	3000 K	86.00
38262643	Titanium matte	740 lm	2700 K	86.00
38364643	Titanium matte	740 lm	3000 K	86.00

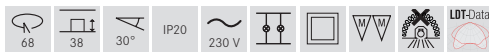

MM sign of the luminaire included in the set.

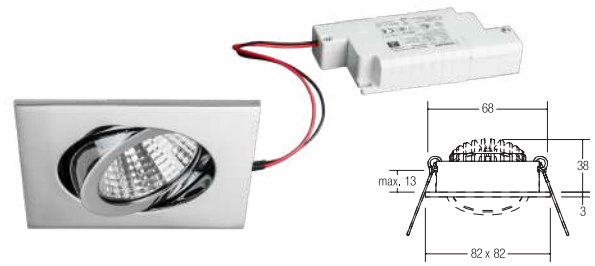

LED recessed spotlight set, dimmable phase section

NEW

Set including converter for 230 V mains voltage, dimmable phase section, dimensions of converter: L 110 x W 50 x H 19 mm

Illuminants: LED, color rendering: CRI > 80, power: 7 W, beam angle: 38°, material: Aluminum / Polycarbonate

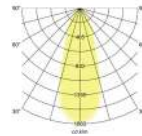

Item no.	Color	Luminous flux	Color temperature	Price €
39262023	Chromium	740 lm	2700 K	81.40
39364023	Chromium	740 lm	3000 K	81.40
39262073	White	740 lm	2700 K	80.40
39364073	White	740 lm	3000 K	80.40
39262083	NEW Black	740 lm	2700 K	80.40
39364083	NEW Black	740 lm	3000 K	80.40
39262253	Aluminum matte	740 lm	2700 K	84.60
39364253	Aluminum matte	740 lm	3000 K	84.60
39262633	Champagne matte	740 lm	2700 K	89.90
39364633	Champagne matte	740 lm	3000 K	89.90
39262643	Titanium matte	740 lm	2700 K	89.90
39364643	Titanium matte	740 lm	3000 K	89.90

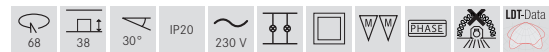

MM sign of the luminaire included in the set.

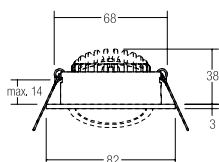

LED recessed spotlight, dim2warm

If the luminaire is dimmed, the color temperature reduces.

Illuminants: LED, model: Plug&Play, color rendering: CRI > 80, power: 6 W, beam angle: 38°, material: Aluminum / Plastic

You will find the corresponding 350-mA converters from page 516 onwards.

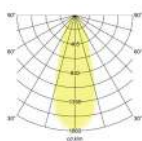

Item no.	Color	Luminous flux	Color temperature	Price €
12461073	White	460 lm	3000 K - 1800 K	64.60
12461253	Aluminum matte	460 lm	3000 K - 1800 K	69.10

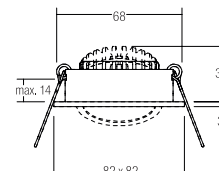

LED recessed spotlight, dim2warm

If the luminaire is dimmed, the color temperature reduces.

Illuminants: LED, model: Plug&Play, color rendering: CRI > 80, power: 6 W, beam angle: 38°, material: Aluminum / Plastic

You will find the corresponding 350-mA converters from page 516 onwards.

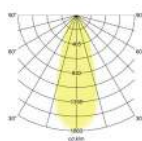

Item no.	Color	Luminous flux	Color temperature	Price €
12462073	White	460 lm	3000 K - 1800 K	67.90
12462253	Aluminum matte	460 lm	3000 K - 1800 K	72.40

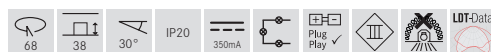

LED recessed spotlight set, dim2warm, dimmable phase section

If the luminaire is dimmed, the color temperature reduces.

Set including converter for 230 V mains voltage, dimmable phase section, dimensions of converter: L 110 x W 50 x H 19 mm

Illuminants: LED, color rendering: CRI > 80, power: 6 W, beam angle: 38°, material: Aluminum / Plastic

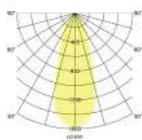

Item no.	Color	Luminous flux	Color temperature	Price €
39461073	White	460 lm	3000 K - 1800 K	92.00
39461253	Aluminum matte	460 lm	3000 K - 1800 K	96.50



LED recessed spotlight set, dim2warm, dimmable phase section

If the luminaire is dimmed, the color temperature reduces.

Set including converter for 230 V mains voltage, dimmable phase section, dimensions of converter: L 110 x W 50 x H 19 mm

Illuminants: LED, color rendering: CRI > 80, power: 6 W, beam angle: 38°, material: Aluminum / Plastic

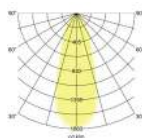

Item no.	Color	Luminous flux	Color temperature	Price €
39462073	White	460 lm	3000 K - 1800 K	95.30
39462253	Aluminum matte	460 lm	3000 K - 1800 K	99.80

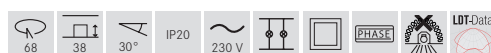

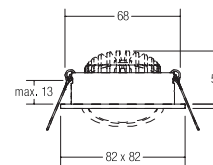
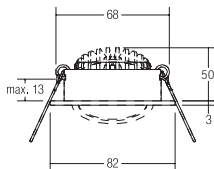

LED recessed spotlight

NEW

Illuminants: LED, model: Plug&Play, color rendering: CRI > 80, power: 3 W, beam angle: 38°, material: Aluminum / Glass

You will find the corresponding 350-mA converters from page 516 onwards.

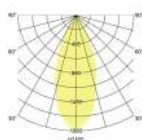

Item no.	Color	Luminous flux	Color temperature	Price €
12371023	NEW Chromium	290 lm	2700 K	43.20
12373023	NEW Chromium	310 lm	3000 K	43.20
12373024	NEW Chromium	340 lm	4000 K	43.20
12371073	NEW White	290 lm	2700 K	39.90
12373073	NEW White	310 lm	3000 K	39.90
12373074	NEW White	340 lm	4000 K	39.90
12371083	NEW Black	290 lm	2700 K	39.90
12373083	NEW Black	310 lm	3000 K	39.90
12373084	NEW Black	340 lm	4000 K	39.90
12371253	NEW Aluminum matte	290 lm	2700 K	42.30
12373253	NEW Aluminum matte	310 lm	3000 K	42.30
12373254	NEW Aluminum matte	340 lm	4000 K	42.30
12371633	NEW Champagne matte	290 lm	2700 K	45.50
12373633	NEW Champagne matte	310 lm	3000 K	45.50
12373634	NEW Champagne matte	340 lm	4000 K	45.50
12371643	NEW Titanium matte	290 lm	2700 K	45.50
12373643	NEW Titanium matte	310 lm	3000 K	45.50
12373644	NEW Titanium matte	340 lm	4000 K	45.50

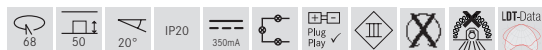

LED recessed spotlight

NEW

Illuminants: LED, model: Plug&Play, color rendering: CRI > 80, power: 3 W, beam angle: 38°, material: Aluminum / Glass

You will find the corresponding 350-mA converters from page 516 onwards.

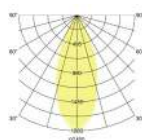

Item no.	Color	Luminous flux	Color temperature	Price €
12374023	NEW Chromium	290 lm	2700 K	45.50
12376023	NEW Chromium	310 lm	3000 K	45.50
12376024	NEW Chromium	340 lm	4000 K	45.50
12374073	NEW White	290 lm	2700 K	42.30
12376073	NEW White	310 lm	3000 K	42.30
12376074	NEW White	340 lm	4000 K	42.30
12374083	NEW Black	290 lm	2700 K	42.30
12376083	NEW Black	310 lm	3000 K	42.30
12376084	NEW Black	340 lm	4000 K	42.30
12374253	NEW Aluminum matte	290 lm	2700 K	44.80
12376253	NEW Aluminum matte	310 lm	3000 K	44.80
12376254	NEW Aluminum matte	340 lm	4000 K	44.80
12374633	NEW Champagne matte	290 lm	2700 K	48.00
12376633	NEW Champagne matte	310 lm	3000 K	48.00
12376634	NEW Champagne matte	340 lm	4000 K	48.00
12374643	NEW Titanium matte	290 lm	2700 K	48.00
12376643	NEW Titanium matte	310 lm	3000 K	48.00
12376644	NEW Titanium matte	340 lm	4000 K	48.00

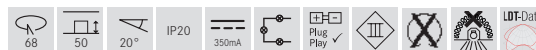

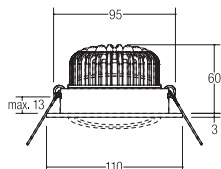

LED recessed spotlight

NEW

Illuminants: LED, model: Plug&Play, color rendering: CRI > 80, power: 12 W, beam angle: 38°, material: Aluminum / Glass

You will find the corresponding 350-mA converters from page 516 onwards.

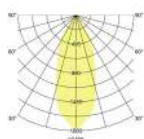

Item no.	Color	Luminous flux	Color temperature	Price €
12395073	NEW White	1,230 lm	3000 K	104.10
12395074	NEW White	1,280 lm	4000 K	104.10
12395083	NEW Black	1,230 lm	3000 K	104.10
12395084	NEW Black	1,280 lm	4000 K	104.10
12395253	NEW Aluminum matte	1,230 lm	3000 K	112.80
12395254	NEW Aluminum matte	1,280 lm	4000 K	112.80

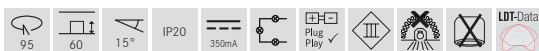

LED recessed spotlight set, dimmable phase section

NEW

Set including converter for 230 V mains voltage, dimmable phase section, dimensions of converter: L 110.5 x W 52 x H 22 mm

Illuminants: LED, color rendering: CRI > 80, power: 12 W, beam angle: 38°, material: Aluminum / Glass

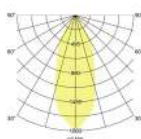

Item no.	Color	Luminous flux	Color temperature	Price €
39395073	NEW White	1,230 lm	3000 K	141.60
39395074	NEW White	1,280 lm	4000 K	141.60
39395083	NEW Black	1,230 lm	3000 K	141.60
39395084	NEW Black	1,280 lm	4000 K	141.60
39395253	NEW Aluminum matte	1,230 lm	3000 K	150.30
39395254	NEW Aluminum matte	1,280 lm	4000 K	150.30

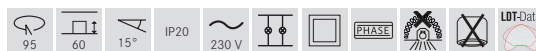

LED recessed spotlight, dim2warm

NEW

If the luminaire is dimmed, the color temperature reduces.

Illuminants: LED, model: Plug&Play, color rendering: CRI > 80, power: 12 W, beam angle: 38°, material: Aluminum / Glass

You will find the corresponding 350-mA converters from page 516 onwards.

Item no.	Color	Luminous flux	Color temperature	Price €
12491073	White	880 lm	3000 K - 1800 K	107.40
12491083	NEW Black	880 lm	3000 K - 1800 K	107.40
12491253	NEW Aluminum matte	880 lm	3000 K - 1800 K	116.20



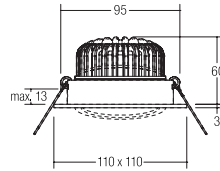

LED recessed spotlight

NEW

Illuminants: LED, model: Plug&Play, color rendering: CRI > 80, power: 12 W, beam angle: 38°, material: Aluminum / Glass

You will find the corresponding 350-mA converters from page 516 onwards.

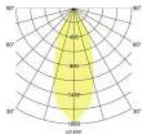

Item no.	Color	Luminous flux	Color temperature	Price €
12396073	NEW White	1,230 lm	3000 K	109.50
12396074	NEW White	1,280 lm	4000 K	109.50
12396083	NEW Black	1,230 lm	3000 K	109.50
12396084	NEW Black	1,280 lm	4000 K	109.50

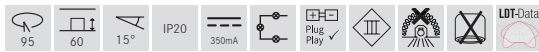

LED recessed spotlight set, dimmable phase section

NEW

Set including converter for 230 V mains voltage, dimmable phase section, dimensions of converter: L 110.5 x W 52 x H 22 mm

Illuminants: LED, color rendering: CRI > 80, power: 12 W, beam angle: 38°, material: Aluminum / Glass

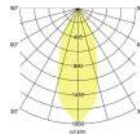

Item no.	Color	Luminous flux	Color temperature	Price €
39396073	NEW White	1,230 lm	3000 K	144.90
39396074	NEW White	1,280 lm	4000 K	144.90
39396083	NEW Black	1,230 lm	3000 K	144.90
39396084	NEW Black	1,280 lm	4000 K	144.90

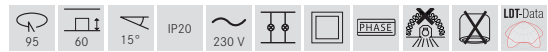

LED recessed spotlight, dim2warm

NEW

If the luminaire is dimmed, the color temperature reduces.

Illuminants: LED, model: Plug&Play, color rendering: CRI > 80, power: 12 W, beam angle: 38°, material: Aluminum / Glass

You will find the corresponding 350-mA converters from page 516 onwards.

Item no.	Color	Luminous flux	Color temperature	Price €
12492073	White	880 lm	3000 K - 1800 K	112.80
12492083	NEW Black	880 lm	3000 K - 1800 K	112.80





Eiswiese (lee meadow), Göttingen

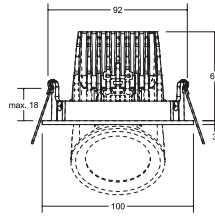

LED recessed spotlight

Illuminants: LED, model: Plug&Play, color rendering: CRI > 80, power: 15 W, beam angle: 36°, material: Aluminum / Plastic

You will find the corresponding 350-mA converters from page 516 onwards.

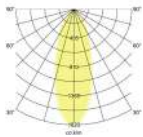

Item no.	Color	Luminous flux	Color temperature	Price €
12401073	White	1,320 lm	3000 K	85.40

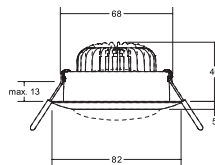

LED recessed spotlight

Illuminants: LED, model: Plug&Play, color rendering: CRI > 80, power: 7 W, beam angle: 40°, material: Aluminum / Plastic

You will find the corresponding 350-mA converters from page 516 onwards.

You will find suitable recessed downlights on page 10.

Item no.	Color	Luminous flux	Color temperature	Price €
12383173	Structural white	600 lm	3000 K	42.30
12383683	Structural silver	600 lm	3000 K	42.30

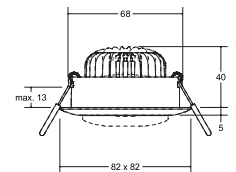

LED recessed spotlight

Illuminants: LED, model: Plug&Play, color rendering: CRI > 80, power: 7 W, beam angle: 40°, material: Aluminum / Plastic

You will find the corresponding 350-mA converters from page 516 onwards.

You will find suitable recessed downlights on page 10.

Item no.	Color	Luminous flux	Color temperature	Price €
12385173	Structural white	600 lm	3000 K	42.30
12385683	Structural silver	600 lm	3000 K	42.30



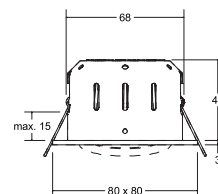
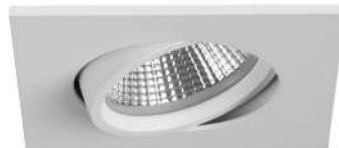
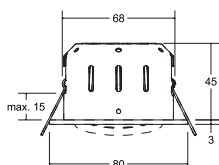

INDIWO68 LED recessed spotlight, swiveling

Recessed spotlights are suitable for direct mounting on normally flammable building materials. Thermal insulation is permissible.

Illuminants: LED, model: Plug&Play, color rendering: CRI > 80, power: 6 W, beam angle: 36°, material: Aluminum / Steel / Plastic

You will find the corresponding 350-mA converters from page 516 onwards.

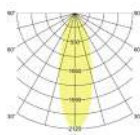

Item no.	Color	Luminous flux	Color temperature	Price €
12293153	Nickel matte	530 lm	3000 K	56.70
12293173	Structural white	530 lm	3000 K	51.90
12293643	Titanium matte	530 lm	3000 K	62.20



INDIWO68 LED recessed spotlight, swiveling

Recessed spotlights are suitable for direct mounting on normally flammable building materials. Thermal insulation is permissible.

Illuminants: LED, model: Plug&Play, color rendering: CRI > 80, power: 6 W, beam angle: 36°, material: Aluminum / Steel / Plastic

You will find the corresponding 350-mA converters from page 516 onwards.

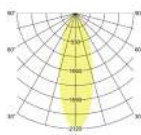

Item no.	Color	Luminous flux	Color temperature	Price €
12295153	Nickel matte	540 lm	3000 K	60.60
12295173	Structural white	540 lm	3000 K	55.80
12295643	Titanium matte	540 lm	3000 K	66.20



INDIWO68 LED recessed spotlight, swiveling, dim2warm

If the luminaire is dimmed, the color temperature reduces.

Recessed spotlights are suitable for direct mounting on normally flammable building materials. Thermal insulation is permissible.

Illuminants: LED, model: Plug&Play, color rendering: CRI > 80, power: 6 W, beam angle: 36°, material: Aluminum / Steel / Plastic

You will find the corresponding 350-mA converters from page 516 onwards.

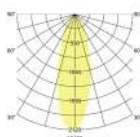

Item no.	Color	Luminous flux	Color temperature	Price €
12463153	Nickel matte	430 lm	3000 K - 1800 K	67.00
12463173	Structural white	430 lm	3000 K - 1800 K	62.10
12463643	Titanium matte	430 lm	3000 K - 1800 K	73.10



INDIWO68 LED recessed spotlight, swiveling, dim2warm

If the luminaire is dimmed, the color temperature reduces.

Recessed spotlights are suitable for direct mounting on normally flammable building materials. Thermal insulation is permissible.

Illuminants: LED, model: Plug&Play, color rendering: CRI > 80, power: 6 W, beam angle: 36°, material: Aluminum / Steel / Plastic

You will find the corresponding 350-mA converters from page 516 onwards.

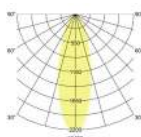

Item no.	Color	Luminous flux	Color temperature	Price €
12465153	Nickel matte	420 lm	3000 K - 1800 K	71.00
12465173	Structural white	420 lm	3000 K - 1800 K	66.10
12465643	Titanium matte	420 lm	3000 K - 1800 K	77.00



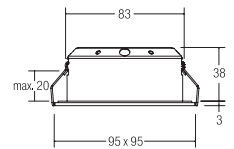
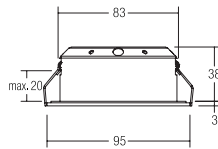

INDIWO83 LED recessed spotlight, swiveling

Recessed spotlights are suitable for direct mounting on normally flammable building materials. Thermal insulation is permissible.

Illuminants: LED, model: Plug&Play, color rendering: CRI > 80, power: 6 W, beam angle: 36°, material: Aluminum / Steel / Plastic

You will find the corresponding 350-mA converters from page 516 onwards.

You will find suitable IP variants on page 115.

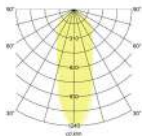

Item no.	Color	Luminous flux	Color temperature	Price €
12276153	Nickel matte	520 lm	3000 K	59.30
12276173	Structural white	520 lm	3000 K	52.70



INDIWO83 LED recessed spotlight, swiveling

Recessed spotlights are suitable for direct mounting on normally flammable building materials. Thermal insulation is permissible.

Illuminants: LED, model: Plug&Play, color rendering: CRI > 80, power: 6 W, beam angle: 36°, material: Aluminum / Steel / Plastic

You will find the corresponding 350-mA converters from page 516 onwards.

You will find suitable IP variants on page 115.

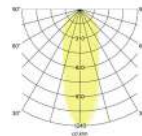

Item no.	Color	Luminous flux	Color temperature	Price €
12286153	Nickel matte	530 lm	3000 K	63.80
12286173	Structural white	530 lm	3000 K	57.20



INDIWO83 LED recessed spotlight, swiveling, dim2warm

If the luminaire is dimmed, the color temperature reduces.

Recessed spotlights are suitable for direct mounting on normally flammable building materials. Thermal insulation is permissible.

Illuminants: LED, model: Plug&Play, color rendering: CRI > 80, power: 6 W, beam angle: 36°, material: Aluminum / Steel / Plastic

You will find the corresponding 350-mA converters from page 516 onwards.

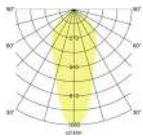

Item no.	Color	Luminous flux	Color temperature	Price €
12476153	Nickel matte	400 lm	3000 K - 1800 K	72.40
12476173	Structural white	400 lm	3000 K - 1800 K	65.50



INDIWO83 LED recessed spotlight, swiveling, dim2warm

If the luminaire is dimmed, the color temperature reduces.

Recessed spotlights are suitable for direct mounting on normally flammable building materials. Thermal insulation is permissible.

Illuminants: LED, model: Plug&Play, color rendering: CRI > 80, power: 6 W, beam angle: 36°, material: Aluminum / Steel / Plastic

You will find the corresponding 350-mA converters from page 516 onwards.

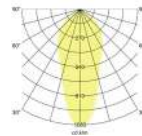

Item no.	Color	Luminous flux	Color temperature	Price €
12486153	Nickel matte	400 lm	3000 K - 1800 K	77.70
12486173	Structural white	400 lm	3000 K - 1800 K	71.00



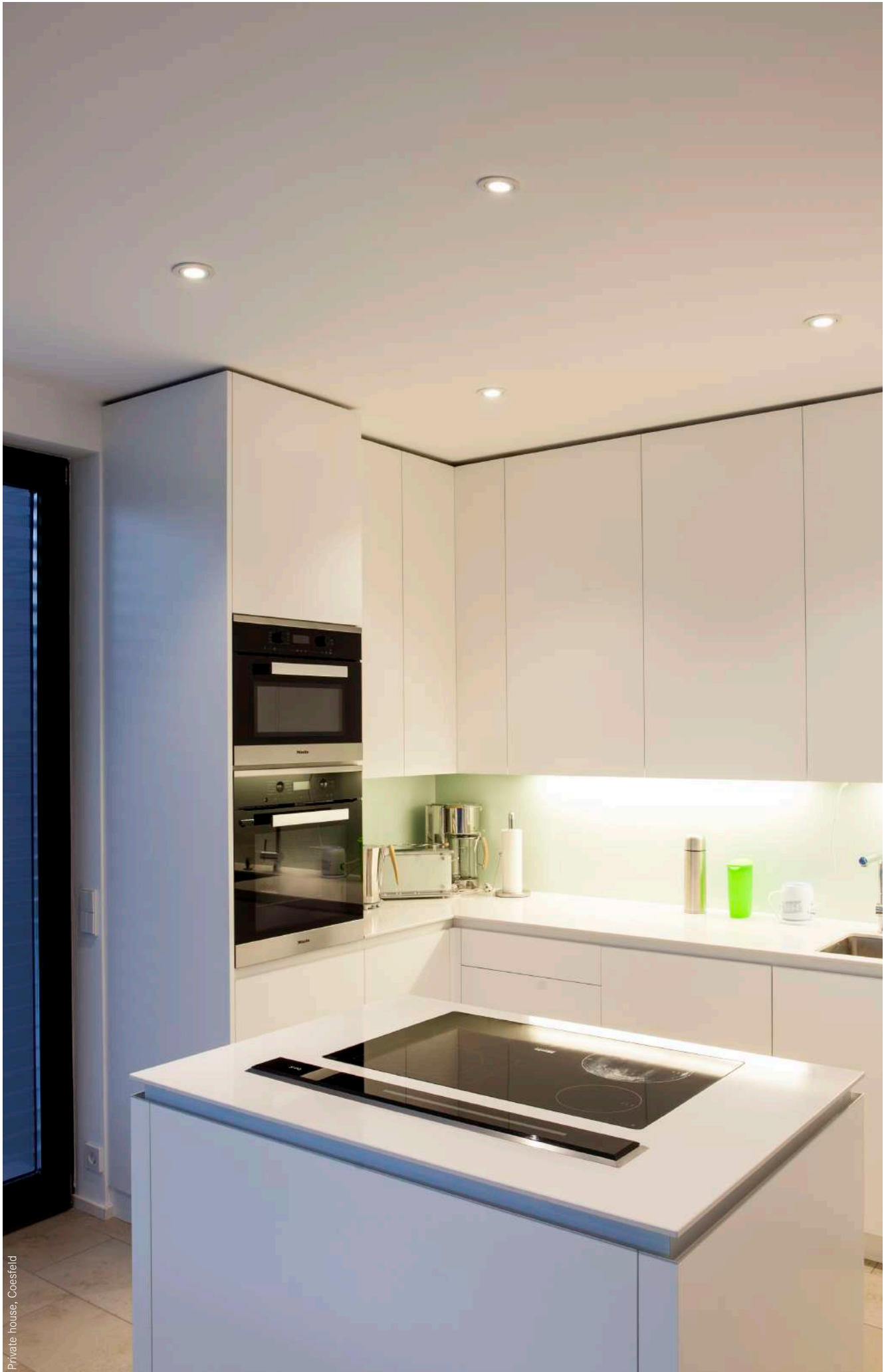

Private house, Coesfeld



ARUN LED recessed spotlight

Illuminants: LED, color rendering: CRI > 80, power: 12.2 W, beam angle: 29°, material: Aluminum / Plastic

You will find the corresponding 350-mA converters from page 516 onwards.

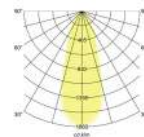
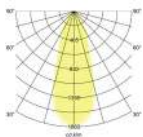

Item no.	Color	Luminous flux	Color temperature	Price €
12603173	Structural white	1,300 lm	3000 K	107.60

Item no.	Color	Luminous flux	Color temperature	Price €
12608173	Structural white	1,300 lm	3000 K	107.60



ARUN LED recessed spotlight, 2x

Illuminants: LED, color rendering: CRI > 80, power: 2 x 12.2 W, beam angle: 29°, luminous flux: 2 x 1,300 lm, material: Aluminum / Plastic

You will find the corresponding 350-mA converters from page 516 onwards.

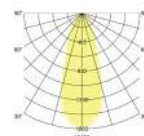
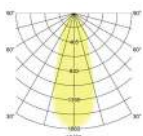

Item no.	Color	Luminous flux	Color temperature	Price €
12613173	Structural white	2,600 lm	3000 K	207.50

Item no.	Color	Luminous flux	Color temperature	Price €
12618173	Structural white	2,600 lm	3000 K	207.50



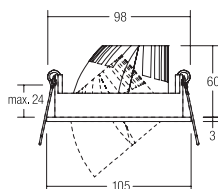

CIRCLE LED recessed spotlight, with circumferential light joint

Illuminants: LED, color rendering: CRI > 90, power: 9.3 W, beam angle: 32°, material: Aluminum / Plastic

You will find the corresponding 500-mA converter on page 522.

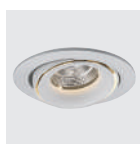

Item no.	Color	Luminous flux	Color temperature	Price €
12417173	Structural white	700 lm	3000 K	93.20

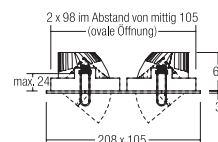

CIRCLE LED recessed spotlight, 2x, with circumferential light joint

Illuminants: LED, color rendering: CRI > 90, power: 2 x 9.3 W, beam angle: 32°, luminous flux: 2 x 700 lm, material: Aluminum / Plastic

You will find the corresponding 500-mA converter on page 522.



Item no.	Color	Luminous flux	Color temperature	Price €
12420173	Structural white	1,400 lm	3000 K	188.60

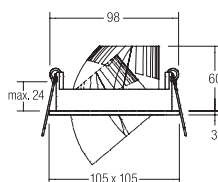
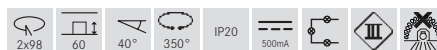

CIRCLE LED recessed spotlight, with circumferential light joint

Illuminants: LED, color rendering: CRI > 90, power: 9.3 W, beam angle: 32°, material: Aluminum / Plastic

You will find the corresponding 500-mA converter on page 522.



Item no.	Color	Luminous flux	Color temperature	Price €
12418173	Structural white	700 lm	3000 K	93.20

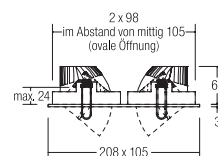
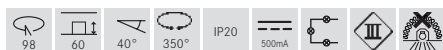

CIRCLE LED recessed spotlight, 2x, with circumferential light joint

Illuminants: LED, color rendering: CRI > 90, power: 2 x 9.3 W, beam angle: 32°, luminous flux: 2 x 700 lm, material: Aluminum / Plastic

You will find the corresponding 500-mA converter on page 522.

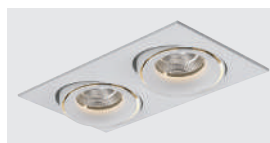

Item no.	Color	Luminous flux	Color temperature	Price €
12419173	Structural white	1,400 lm	3000 K	188.60

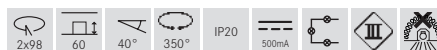

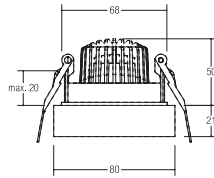

TUBIC LED recessed spotlight

Illuminants: LED, model: Plug&Play, color rendering: CRI > 80, power: 6 W, beam angle: 38°, material: Aluminum / Glass

You will find the corresponding 350-mA converters from page 516 onwards.

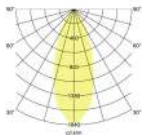

Item no.	Color	Luminous flux	Color temperature	Price €
13126173	Structural white	680 lm	3000 K	80.20

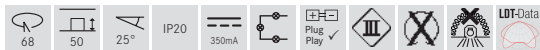

Design: Alexander Grimm (Lounge Design)
Idea: Michael Ruschmann (Lichtraum Ruschmann Stein GmbH)

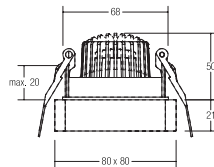

QUBIC LED recessed spotlight

Illuminants: LED, model: Plug&Play, color rendering: CRI > 80, power: 6 W, beam angle: 38°, material: Aluminum / Glass

You will find the corresponding 350-mA converters from page 516 onwards.

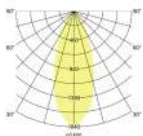

Item no.	Color	Luminous flux	Color temperature	Price €
13127173	Structural white	680 lm	3000 K	84.50

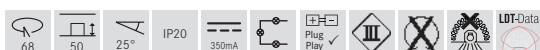

Design: Lounge Design (Alexander Grimm and Ronny Eysser)
Idea: Lichtraum Ruschmann Stein GmbH (Michael Ruschmann)

TUBIC product family



TUBIC LED recessed ceiling luminaire, with indirect component

Item no. 12226173
See page 14



TUBIC LED ceiling-mounted luminaire, with indirect component

Item no. 12042173
See page 165



TUBIC LED wall surface-mounted luminaire, with indirect component

Item no. 10042173
See page 224

QUBIC product family



QUBIC LED recessed ceiling luminaire, with indirect component

Item no. 12227173
See page 14



QUBIC LED ceiling-mounted luminaire, with indirect component

Item no. 12040173
See page 165



QUBIC LED wall surface-mounted luminaire, with indirect component

Item no. 10040173
See page 224



Recessed spotlight, GX5.3

Illuminants: For LED retrofit lamp, model: GX5.3, power: maximum 50 W, material: Aluminum

Item no.	Color	Price €
0063.02	Chromium	21.00
0063.07	White	19.90
0063.08	Black	19.90
0063.25	Aluminum matte	19.90
0063.63	Champagne matte	24.50
0063.64	Titanium matte	24.50



Recessed spotlight, GU10

Including bracket with GU10 holder for standard-compliant strain relief.

Illuminants: For LED retrofit lamp, model: GU10, power: maximum 50 W, material: Aluminum

Item no.	Color	Price €
36143020	Chromium	32.00
36143070	White	30.90
36143080	Black	30.90
36143250	Aluminum matte	30.90
36143630	Champagne matte	35.50
36143640	Titanium matte	35.50



LED recessed spotlight set, switchable

Set including converter for 230 V mains voltage, switchable, dimensions of converter: L 68 x W 35 x H 21 mm

Illuminants: LED, color rendering: CRI > 80, power: 6 W, beam angle: 38°, material: Aluminum / Glass / Plastic

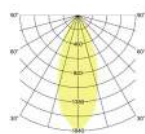

Item no.	Color	Luminous flux	Color temperature	Price €
38143023	Chromium	680 lm	3000 K	96.30
38143073	White	680 lm	3000 K	95.20
38143083	Black	680 lm	3000 K	95.20
38143253	Aluminum matte	680 lm	3000 K	95.20
38143633	Champagne matte	680 lm	3000 K	99.80
38143643	Titanium matte	680 lm	3000 K	99.80



LED recessed spotlight set, dimmable phase section

NEW

Set including converter for 230 V mains voltage, dimmable phase section, dimensions of converter: L 110 x W 50 x H 19 mm

Illuminants: LED, color rendering: CRI > 80, power: 6 W, beam angle: 38°, material: Aluminum / Glass / Plastic

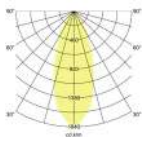

Item no.	Color	Luminous flux	Color temperature	Price €
39143023	NEW Chromium	680 lm	3000 K	100.20
39143073	NEW White	680 lm	3000 K	99.10
39143083	NEW Black	680 lm	3000 K	99.10
39143253	NEW Aluminum matte	680 lm	3000 K	99.10
39143633	NEW Champagne matte	680 lm	3000 K	103.70
39143643	NEW Titanium matte	680 lm	3000 K	103.70

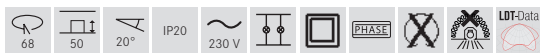

LED recessed spotlight set, dimmable phase section (Round converter)

NEW

Set including converter for 230 V mains voltage, dimmable phase section, dimensions of converter: D 51 x H 24 mm

Illuminants: LED, color rendering: CRI > 80, power: 6 W, beam angle: 38°, material: Aluminum / Glass / Plastic

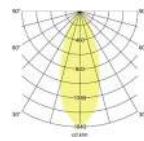

Item no.	Color	Luminous flux	Color temperature	Price €
40143023	NEW Chromium	680 lm	3000 K	110.70
40143073	NEW White	680 lm	3000 K	109.60
40143083	NEW Black	680 lm	3000 K	109.60
40143253	NEW Aluminum matte	680 lm	3000 K	109.60
40143633	NEW Champagne matte	680 lm	3000 K	114.20
40143643	NEW Titanium matte	680 lm	3000 K	114.20

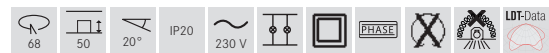

LED recessed spotlight set, dimmable DALI, with connection box

NEW

Set including converter for 230 V mains voltage, dimmable DALI-2, dimensions of converter: L 130 x W 42 x H 22 mm

Illuminants: LED, color rendering: CRI > 80, power: 6 W, beam angle: 38°, material: Aluminum / Glass / Plastic, delivery: including connection box, 5-pin

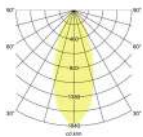

Item no.	Color	Luminous flux	Color temperature	Price €
41443023	NEW Chromium	680 lm	3000 K	142.70
41443073	NEW White	680 lm	3000 K	141.60
41443083	NEW Black	680 lm	3000 K	141.60
41443253	NEW Aluminum matte	680 lm	3000 K	141.60
41443633	NEW Champagne matte	680 lm	3000 K	146.20
41443643	NEW Titanium matte	680 lm	3000 K	146.20

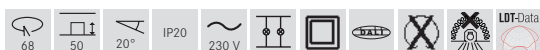

Loudspeaker variant



Recessed ceiling loudspeaker

Item no.: 43003...

See page 89

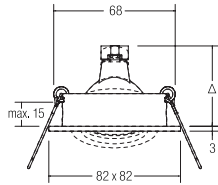

Recessed spotlight, GX5.3

Illuminants: For LED retrofit lamp, model: GX5.3, power: maximum 50 W, material: Aluminum

Item no.	Color	Price €
0065.02	Chromium	23.50
0065.07	White	22.00
0065.08	Black	22.00
0065.25	Aluminum matte	22.00
0065.63	Champagne matte	27.00
0065.64	Titanium matte	27.00



Recessed spotlight, GU10

Including bracket with GU10 holder for standard-compliant strain relief.

Illuminants: For LED retrofit lamp, model: GU10, power: maximum 50 W, material: Aluminum

Item no.	Color	Price €
36144020	Chromium	34.50
36144070	White	33.00
36144080	Black	33.00
36144250	Aluminum matte	33.00
36144630	Champagne matte	38.00
36144640	Titanium matte	38.00



LED recessed spotlight set, switchable

Set including converter for 230 V mains voltage, switchable, dimensions of converter: L 68 x W 35 x H 21 mm

Illuminants: LED, color rendering: CRI > 80, power: 6 W, beam angle: 38°, material: Aluminum / Glass / Plastic

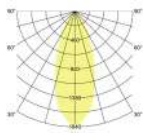

Item no.	Color	Luminous flux	Color temperature	Price €
38144023	Chromium	680 lm	3000 K	98.90
38144073	White	680 lm	3000 K	97.30
38144083	Black	680 lm	3000 K	97.30
38144253	Aluminum matte	680 lm	3000 K	97.30
38144633	Champagne matte	680 lm	3000 K	102.30
38144643	Titanium matte	680 lm	3000 K	102.30



LED recessed spotlight set, dimmable phase section

NEW

Set including converter for 230 V mains voltage, dimmable phase section, dimensions of converter: L 110 x W 50 x H 19 mm

Illuminants: LED, color rendering: CRI > 80, power: 6 W, beam angle: 38°, material: Aluminum / Glass / Plastic

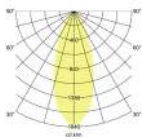

Item no.	Color	Luminous flux	Color temperature	Price €
39144023	NEW Chromium	680 lm	3000 K	102.70
39144073	NEW White	680 lm	3000 K	101.20
39144083	NEW Black	680 lm	3000 K	101.20
39144253	NEW Aluminum matte	680 lm	3000 K	101.20
39144633	NEW Champagne matte	680 lm	3000 K	106.20
39144643	NEW Titanium matte	680 lm	3000 K	106.20

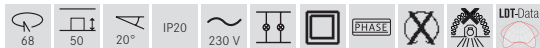

LED recessed spotlight set, dimmable phase section (Round converter)

NEW

Set including converter for 230 V mains voltage, dimmable phase section, dimensions of converter: D 51 x H 24 mm

Illuminants: LED, color rendering: CRI > 80, power: 6 W, beam angle: 38°, material: Aluminum / Glass / Plastic

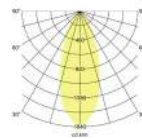

Item no.	Color	Luminous flux	Color temperature	Price €
40144023	NEW Chromium	680 lm	3000 K	113.20
40144073	NEW White	680 lm	3000 K	111.70
40144083	NEW Black	680 lm	3000 K	111.70
40144253	NEW Aluminum matte	680 lm	3000 K	111.70
40144633	NEW Champagne matte	680 lm	3000 K	116.70
40144643	NEW Titanium matte	680 lm	3000 K	116.70

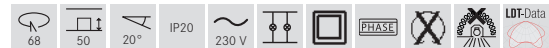

LED recessed spotlight set, dimmable DALI, with connection box

NEW

Set including converter for 230 V mains voltage, dimmable DALI-2, dimensions of converter: L 130 x W 42 x H 22 mm

Illuminants: LED, color rendering: CRI > 80, power: 6 W, beam angle: 38°, material: Aluminum / Glass / Plastic, delivery: including connection box, 5-pin

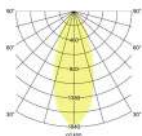

Item no.	Color	Luminous flux	Color temperature	Price €
41444023	NEW Chromium	680 lm	3000 K	145.20
41444073	NEW White	680 lm	3000 K	143.70
41444083	NEW Black	680 lm	3000 K	143.70
41444253	NEW Aluminum matte	680 lm	3000 K	143.70
41444633	NEW Champagne matte	680 lm	3000 K	148.70
41444643	NEW Titanium matte	680 lm	3000 K	148.70

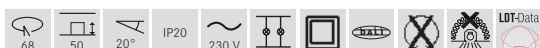

Loudspeaker variant



Recessed ceiling loudspeaker

Item no.: 43004...

See page 89

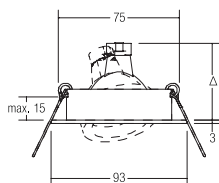

Recessed spotlight, GX5.3

Illuminants: For LED retrofit lamp, model: GX5.3, power: maximum 50 W, material: Aluminum

Item no.	Color	Price €
0069.25	Aluminum matte	25.50



Recessed spotlight, GU10

Including bracket with GU10 holder for standard-compliant strain relief.

Illuminants: For LED retrofit lamp, model: GU10, power: maximum 50 W, material: Aluminum

Item no.	Color	Price €
36309250	Aluminum matte	36.50



LED recessed spotlight set, switchable

Set including converter for 230 V mains voltage, switchable, dimensions of converter: L 68 x W 35 x H 21 mm

Illuminants: LED, color rendering: CRI > 80, power: 6 W, beam angle: 38°, material: Aluminum / Glass / Plastic

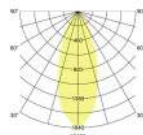

Item no.	Color	Luminous flux	Color temperature	Price €
38309253	Aluminum matte	680 lm	3000 K	100.80



LED recessed spotlight set, dimmable phase section

NEW

Set including converter for 230 V mains voltage, dimmable phase section, dimensions of converter: L 110 x W 50 x H 19 mm

Illuminants: LED, color rendering: CRI > 80, power: 6 W, beam angle: 38°, material: Aluminum / Glass / Plastic

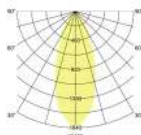

Item no.	Color	Luminous flux	Color temperature	Price €
39309253	NEW Aluminum matte	680 lm	3000 K	104.70

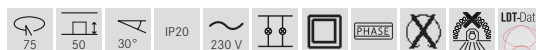

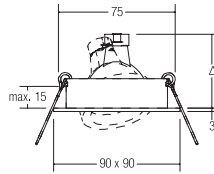

Recessed spotlight, GX5.3

Illuminants: For LED retrofit lamp, model: GX5.3, power: maximum 50 W, material: Aluminum

Item no.	Color	Price €
0070.25	Aluminum matte	28.00

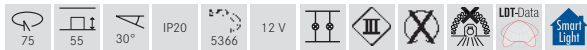

Recessed spotlight, GU10

Including bracket with GU10 holder for standard-compliant strain relief.

Illuminants: For LED retrofit lamp, model: GU10, power: maximum 50 W, material: Aluminum

Item no.	Color	Price €
36310250	Aluminum matte	39.00



LED recessed spotlight set, switchable

Set including converter for 230 V mains voltage, switchable, dimensions of converter: L 68 x W 35 x H 21 mm

Illuminants: LED, color rendering: CRI > 80, power: 6 W, beam angle: 38°, material: Aluminum / Glass / Plastic

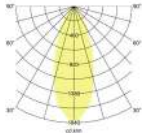

Item no.	Color	Luminous flux	Color temperature	Price €
38310253	Aluminum matte	680 lm	3000 K	103.30



LED recessed spotlight set, dimmable phase section

NEW

Set including converter for 230 V mains voltage, dimmable phase section, dimensions of converter: L 110 x W 50 x H 19 mm

Illuminants: LED, color rendering: CRI > 80, power: 6 W, beam angle: 38°, material: Aluminum / Glass / Plastic

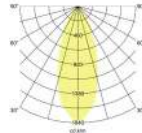

Item no.	Color	Luminous flux	Color temperature	Price €
39310253	NEW Aluminum matte	680 lm	3000 K	107.20

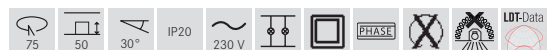

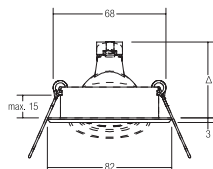

Recessed spotlight, GX5.3

Illuminants: For LED retrofit lamp, model: GX5.3, power: maximum 50 W, material: Aluminum

Item no.	Color	Price €
0064.00	Black / aluminum matte	22.00



Recessed spotlight, GU10

Including bracket with GU10 holder for standard-compliant strain relief.

Illuminants: For LED retrofit lamp, model: GU10, power: maximum 50 W, material: Aluminum

Item no.	Color	Price €
36187250	Black / aluminum matte	33.00



LED recessed spotlight set, switchable

Set including converter for 230 V mains voltage, switchable, dimensions of converter: L 68 x W 35 x H 21 mm

Illuminants: LED, color rendering: CRI > 80, power: 6 W, beam angle: 38°, material: Aluminum / Glass / Plastic

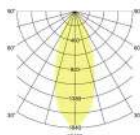

Item no.	Color	Luminous flux	Color temperature	Price €
38187253	Black / aluminum matte	680 lm	3000 K	97.30



LED recessed spotlight set, dimmable phase section

NEW

Set including converter for 230 V mains voltage, dimmable phase section, dimensions of converter: L 110 x W 50 x H 19 mm

Illuminants: LED, color rendering: CRI > 80, power: 6 W, beam angle: 38°, material: Aluminum / Glass / Plastic

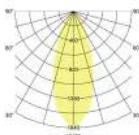

Item no.	Color	Luminous flux	Color temperature	Price €
39187253	NEW Black / aluminum matte	680 lm	3000 K	101.20

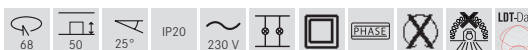

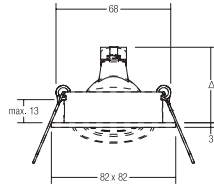

Recessed spotlight, GX5.3

Illuminants: For LED retrofit lamp, model: GX5.3, power: maximum 50 W, material: Aluminum

Item no.	Color	Price €
0066.00	Black / aluminum matte	27.00

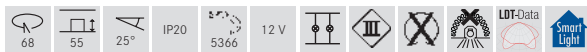

Recessed spotlight, GU10

Including bracket with GU10 holder for standard-compliant strain relief.

Illuminants: For LED retrofit lamp, model: GU10, power: maximum 50 W, material: Aluminum

Item no.	Color	Price €
36188250	Black / aluminum matte	38.00



LED recessed spotlight set, switchable

Set including converter for 230 V mains voltage, switchable, dimensions of converter: L 68 x W 35 x H 21 mm

Illuminants: LED, color rendering: CRI > 80, power: 6 W, beam angle: 38°, material: Aluminum / Glass / Plastic

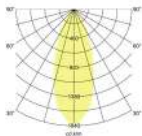

Item no.	Color	Luminous flux	Color temperature	Price €
38188253	Black / aluminum matte	680 lm	3000 K	102.30



LED recessed spotlight set, dimmable phase section

NEW

Set including converter for 230 V mains voltage, dimmable phase section, dimensions of converter: L 110 x W 50 x H 19 mm

Illuminants: LED, color rendering: CRI > 80, power: 6 W, beam angle: 38°, material: Aluminum / Glass / Plastic

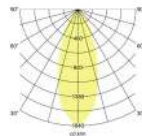

Item no.	Color	Luminous flux	Color temperature	Price €
39188253	NEW Black / aluminum matte	680 lm	3000 K	106.20

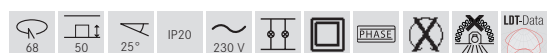



Recessed spotlight, GX5.3

Illuminants: For LED retrofit lamp, model: GX5.3, power: maximum 50 W, material: Aluminum

Item no.	Color	Price €
0063.60	White	31.50
0063.62	Aluminum matte	31.50



Recessed spotlight, GU10

NEW

Including bracket with GU10 holder for standard-compliant strain relief.

Illuminants: For LED retrofit lamp, model: GU10, power: maximum 50 W, material: Aluminum

Item no.	Color	Price €
36063070	NEW White	42.50
36063250	NEW Aluminum matte	42.50



LED recessed spotlight set, switchable

NEW

Set including converter for 230 V mains voltage, switchable, dimensions of converter: L 68 x W 35 x H 21 mm

Illuminants: LED, color rendering: CRI > 80, power: 6 W, beam angle: 38°, material: Aluminum / Glass / Plastic

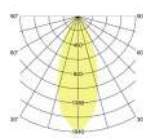

Item no.	Color	Luminous flux	Color temperature	Price €
38063073	NEW White	680 lm	3000 K	106.80
38063253	NEW Aluminum matte	680 lm	3000 K	106.80



LED recessed spotlight set, dimmable phase section

NEW

Set including converter for 230 V mains voltage, dimmable phase section, dimensions of converter: L 110 x W 50 x H 19 mm

Illuminants: LED, color rendering: CRI > 80, power: 6 W, beam angle: 38°, material: Aluminum / Glass / Plastic

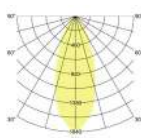

Item no.	Color	Luminous flux	Color temperature	Price €
39063073	NEW White	680 lm	3000 K	110.70
39063253	NEW Aluminum matte	680 lm	3000 K	110.70

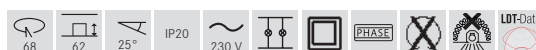



DISC LED recessed spotlight, with lens optics

Illuminants: LED, model: Plug&Play, color rendering: CRI > 80, power: 6 W, beam angle: 38°, material: Aluminum / Plastic

You will find the corresponding 350-mA converters from page 516 onwards.

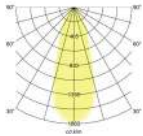

Item no.	Color	Luminous flux	Color temperature	Price €
12321023	Chromium	660 lm	3000 K	52.70
12321024	Chromium	700 lm	4000 K	52.70
12321073	White	660 lm	3000 K	42.90
12321074	White	700 lm	4000 K	42.90
12321253	Aluminum matte	660 lm	3000 K	49.40
12321254	Aluminum matte	700 lm	4000 K	49.40

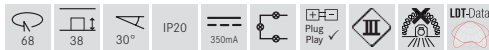

DISC LED recessed spotlight set, with lens optics, switchable

NEW

Set including converter for 230 V mains voltage, switchable, dimensions of converter: L 68 x W 35 x H 21 mm

Illuminants: LED, color rendering: CRI > 80, power: 6 W, beam angle: 38°, material: Aluminum / Plastic

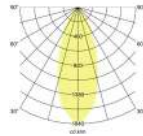

Item no.	Color	Luminous flux	Color temperature	Price €
38421023	NEW Chromium	660 lm	3000 K	76.20
38421024	NEW Chromium	700 lm	4000 K	76.20
38421073	NEW White	660 lm	3000 K	66.40
38421074	NEW White	700 lm	4000 K	66.40
38421253	NEW Aluminum matte	660 lm	3000 K	72.90
38421254	NEW Aluminum matte	700 lm	4000 K	72.90



DISC LED recessed spotlight set, with lens optic, dimmable phase section

NEW

Set including converter for 230 V mains voltage, dimmable phase section, dimensions of converter: L 110 x W 50 x H 19 mm

Illuminants: LED, color rendering: CRI > 80, power: 6 W, beam angle: 38°, material: Aluminum / Plastic

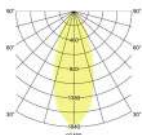

Item no.	Color	Luminous flux	Color temperature	Price €
39421023	NEW Chromium	660 lm	3000 K	80.10
39421024	NEW Chromium	700 lm	4000 K	80.10
39421073	NEW White	660 lm	3000 K	70.30
39421074	NEW White	700 lm	4000 K	70.30
39421253	NEW Aluminum matte	660 lm	3000 K	76.80
39421254	NEW Aluminum matte	700 lm	4000 K	76.80

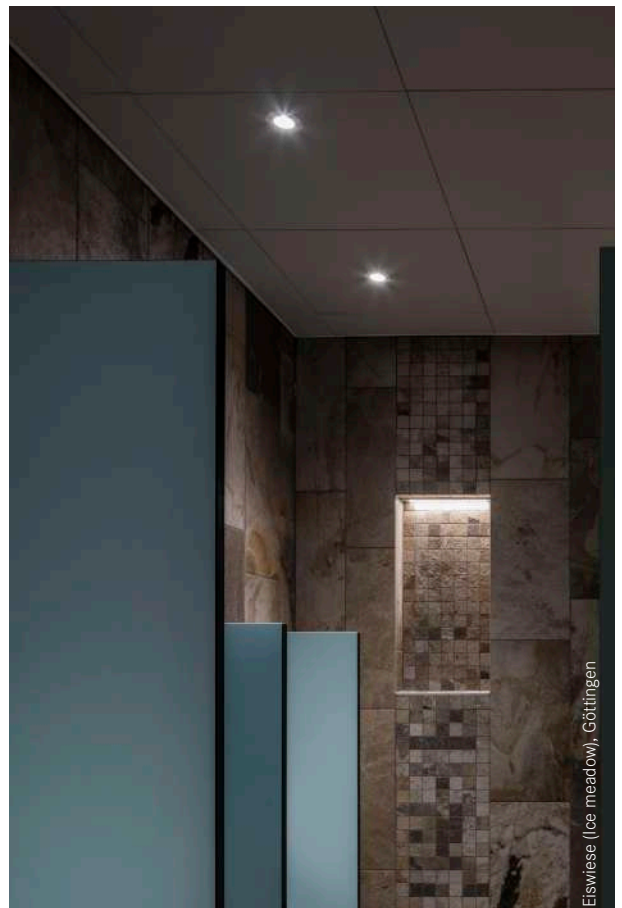

Eiswiese (Ice meadow), Göttingen

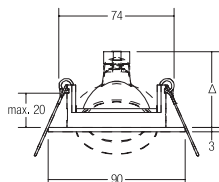

Recessed spotlight, GX5.3

Illuminants: For LED retrofit lamp, model: GX5.3, power: maximum 50 W, material: Aluminum

You will find the IPG65 downlight version on page 123.

Item no.	Color	Price €
20353070	White	23.40
20353150	Nickel matte	25.60
20353680	Silver	23.40



Recessed spotlight, GU10

NEW

Including bracket with GU10 holder for standard-compliant strain relief.

Illuminants: For LED retrofit lamp, model: GU10, power: maximum 50 W, material: Aluminum

Item no.	Color	Price €
36453070	NEW White	34.40
36453150	NEW Nickel matte	36.60
36453680	NEW Silver	34.40



LED recessed spotlight set, switchable

NEW

Set including converter for 230 V mains voltage, switchable, dimensions of converter: L 68 x W 35 x H 21 mm

Illuminants: LED, color rendering: CRI > 80, power: 6 W, beam angle: 38°, material: Aluminum / Glass / Plastic

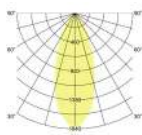

Item no.	Color	Luminous flux	Color temperature	Price €
38453073	NEW White	680 lm	3000 K	98.70
38453153	NEW Nickel matte	680 lm	3000 K	100.90
38453683	NEW Silver	680 lm	3000 K	98.70



LED recessed spotlight set, dimmable phase section

NEW

Set including converter for 230 V mains voltage, dimmable phase section, dimensions of converter: L 110 x W 50 x H 19 mm

Illuminants: LED, color rendering: CRI > 80, power: 6 W, beam angle: 38°, material: Aluminum / Glass / Plastic

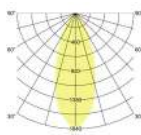

Item no.	Color	Luminous flux	Color temperature	Price €
39453073	NEW White	680 lm	3000 K	102.60
39453153	NEW Nickel matte	680 lm	3000 K	104.80
39453683	NEW Silver	680 lm	3000 K	102.60

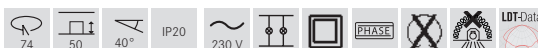

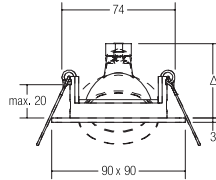

Recessed spotlight, GX5.3

Illuminants: For LED retrofit lamp, model: GX5.3, power: maximum 50 W, material: Aluminum

Item no.	Color	Price €
20355070	White	24.40
20355150	Nickel matte	27.40
20355680	Silver	24.40

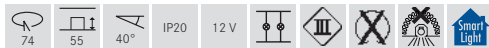

Recessed spotlight, GU10

NEW

Including bracket with GU10 holder for standard-compliant strain relief.

Illuminants: For LED retrofit lamp, model: GU10, power: maximum 50 W, material: Aluminum

Item no.	Color	Price €
36455070	NEW White	35.40
36455150	NEW Nickel matte	38.40
36455680	NEW Silver	35.40



LED recessed spotlight set, switchable

NEW

Set including converter for 230 V mains voltage, switchable, dimensions of converter: L 68 x W 35 x H 21 mm

Illuminants: LED, color rendering: CRI > 80, power: 6 W, beam angle: 38°, material: Aluminum / Glass / Plastic

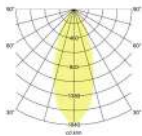

Item no.	Color	Luminous flux	Color temperature	Price €
38455073	NEW White	680 lm	3000 K	99.70
38455153	NEW Nickel matte	680 lm	3000 K	102.70
38455683	NEW Silver	680 lm	3000 K	99.70

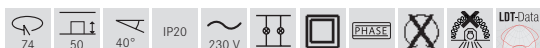

LED recessed spotlight set, dimmable phase section

NEW

Set including converter for 230 V mains voltage, dimmable phase section, dimensions of converter: L 110 x W 50 x H 19 mm

Illuminants: LED, color rendering: CRI > 80, power: 6 W, beam angle: 38°, material: Aluminum / Glass / Plastic

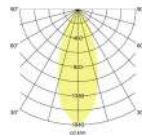

Item no.	Color	Luminous flux	Color temperature	Price €
39455073	NEW White	680 lm	3000 K	103.60
39455153	NEW Nickel matte	680 lm	3000 K	106.60
39455683	NEW Silver	680 lm	3000 K	103.60

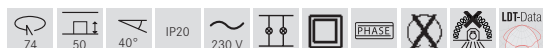

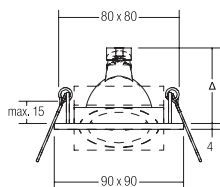

Recessed spotlight, GX5.3

Illuminants: For LED retrofit lamp, model: GX5.3, power: maximum 50 W, material: Aluminum

Recessed spotlight, GU10

NEW

Including bracket with GU10 holder for standard-compliant strain relief.

Illuminants: For LED retrofit lamp, model: GU10, power: maximum 50 W, material: Aluminum

Item no.	Color	Price €
512811	Aluminum matte	43.80

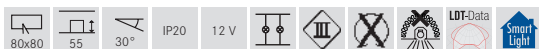

Item no.	Color	Price €
36323250	NEW Aluminum matte	54.80



LED recessed spotlight set, switchable

Set including converter for 230 V mains voltage, switchable, dimensions of converter: L 68 x W 35 x H 21 mm

Illuminants: LED, color rendering: CRI > 80, power: 6 W, beam angle: 38°, material: Aluminum / Glass / Plastic

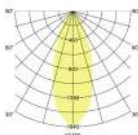

LED recessed spotlight set, dimmable phase section

NEW

Set including converter for 230 V mains voltage, dimmable phase section, dimensions of converter: L 110 x W 50 x H 19 mm

Illuminants: LED, color rendering: CRI > 80, power: 6 W, beam angle: 38°, material: Aluminum / Glass / Plastic

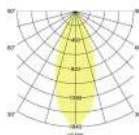

Item no.	Color	Luminous flux	Color temperature	Price €
38323253	Aluminum matte	680 lm	3000 K	119.10



Item no.	Color	Luminous flux	Color temperature	Price €
39323253	NEW Aluminum matte	680 lm	3000 K	123.00

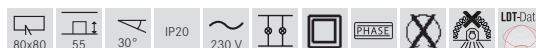

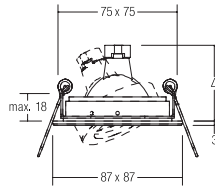

Recessed spotlight, GX5.3

Illuminants: For LED retrofit lamp, model: GX5.3, power: maximum 50 W, material: Aluminum

Item no.	Color	Price €
20001070	White	47.50
20001250	Aluminum matte	47.50



Recessed spotlight, GU10

NEW

Including bracket with GU10 holder for standard-compliant strain relief.

Illuminants: For LED retrofit lamp, model: GU10, power: maximum 50 W, material: Aluminum

Item no.	Color	Price €
36357070	NEW White	58.50
36357250	NEW Aluminum matte	58.50

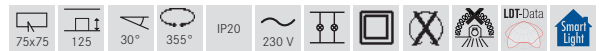

LED recessed spotlight set, switchable

Set including converter for 230 V mains voltage, switchable, dimensions of converter: L 68 x W 35 x H 21 mm

Illuminants: LED, color rendering: CRI > 80, power: 6 W, beam angle: 38°, material: Aluminum / Glass / Plastic

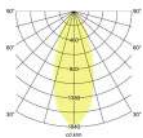

Item no.	Color	Luminous flux	Color temperature	Price €
38357073	White	680 lm	3000 K	122.80
38357253	Aluminum matte	680 lm	3000 K	122.80



LED recessed spotlight set, dimmable phase section

NEW

Set including converter for 230 V mains voltage, dimmable phase section, dimensions of converter: L 110 x W 50 x H 19 mm

Illuminants: LED, color rendering: CRI > 80, power: 6 W, beam angle: 38°, material: Aluminum / Glass / Plastic

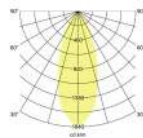

Item no.	Color	Luminous flux	Color temperature	Price €
39357073	NEW White	680 lm	3000 K	126.70
39357253	NEW Aluminum matte	680 lm	3000 K	126.70





Recessed spotlight, GX5.3

Illuminants: For LED retrofit lamp, model: without holder, power: maximum 50 W, material: Aluminum cast

Item no.	Color	Price €
2110.02	Chromium	29.10
2110.07	White	27.40
2110.15	Nickel matte	37.00

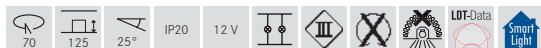

LED recessed spotlight set, switchable

Set including converter for 230 V mains voltage, switchable, dimensions of converter: L 68 x W 35 x H 21 mm

Illuminants: LED, color rendering: CRI > 80, power: 6 W, beam angle: 38°, material: Aluminum cast / Aluminum / Glass / Plastic

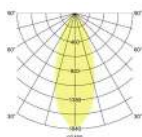

Item no.	Color	Luminous flux	Color temperature	Price €
38326023	Chromium	680 lm	3000 K	104.40
38326073	White	680 lm	3000 K	102.70
38326153	Nickel matte	680 lm	3000 K	112.30



Separate bracket for illuminants

Bracket for recessed spotlights

Suitable brackets must be ordered separately for LED retrofit lamps.

The corresponding holder and the connection plug for the constant current are included in the scope of delivery of the respective bracket.



5387 5397 5388

Item no.	Description	Price €
5387	Bracket for 12 V AC, maximum 50 W	6.20
5397	Bracket for 230 V AC, maximum 50 W	9.20
5388	Bracket for LED 350 mA	9.90

Using the brackets results in a luminaire recess depth of 125 mm.

LED recessed spotlight set, dimmable phase section

NEW

Set including converter for 230 V mains voltage, dimmable phase section, dimensions of converter: L 110 x W 50 x H 19 mm

Illuminants: LED, color rendering: CRI > 80, power: 6 W, beam angle: 38°, material: Aluminum cast / Aluminum / Glass / Plastic

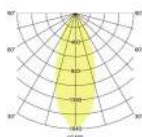

Item no.	Color	Luminous flux	Color temperature	Price €
39326023	NEW Chromium	680 lm	3000 K	108.30
39326073	NEW White	680 lm	3000 K	106.60
39326153	NEW Nickel matte	680 lm	3000 K	116.20

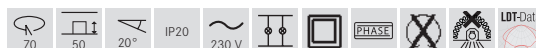

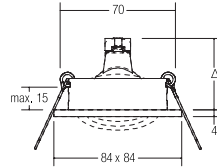

Recessed spotlight, GX5.3

Illuminants: For LED retrofit lamp, model: without holder, power: maximum 50 W, material: Aluminum cast

Item no.	Color	Price €
2111.02	Chromium	30.50
2111.07	White	28.90
2111.15	Nickel matte	38.60

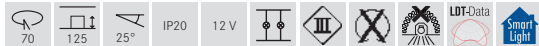

LED recessed spotlight set, switchable

Set including converter for 230 V mains voltage, switchable, dimensions of converter: L 68 x W 35 x H 21 mm

Illuminants: LED, color rendering: CRI > 80, power: 6 W, beam angle: 38°, material: Aluminum cast / Aluminum / Glass / Plastic

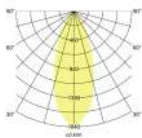

Item no.	Color	Luminous flux	Color temperature	Price €
38327023	Chromium	680 lm	3000 K	105.80
38327073	White	680 lm	3000 K	104.20
38327153	Nickel matte	680 lm	3000 K	113.90



Separate bracket for illuminants

Bracket for recessed spotlights

Suitable brackets must be ordered separately for LED retrofit lamps.

The corresponding holder and the connection plug for the constant current are included in the scope of delivery of the respective bracket.



5387



5397



5388

Item no.	Description	Price €
5387	Bracket for 12 V AC, maximum 50 W	6.20
5397	Bracket for 230 V AC, maximum 50 W	9.20
5388	Bracket for LED 350 mA	9.90

Using the brackets results in a luminaire recess depth of 125 mm.

LED recessed spotlight set, dimmable phase section

NEW

Set including converter for 230 V mains voltage, dimmable phase section, dimensions of converter: L 110 x W 50 x H 19 mm

Illuminants: LED, color rendering: CRI > 80, power: 6 W, beam angle: 38°, material: Aluminum cast / Aluminum / Glass / Plastic

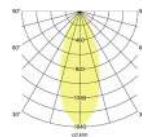

Item no.	Color	Luminous flux	Color temperature	Price €
39327023	NEW Chromium	680 lm	3000 K	109.70
39327073	NEW White	680 lm	3000 K	108.10
39327153	NEW Nickel matte	680 lm	3000 K	117.80

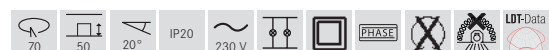

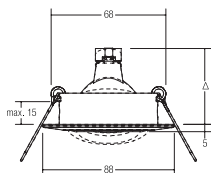

Recessed spotlight, GX5.3

Illuminants: For LED retrofit lamp, model: GX5.3, power: maximum 50 W, material: Cast, delivery: including holder with 300 mm feed line, without circlip

Item no.	Color	Price €
1963.02	Chromium	22.00
1963.03	Chromium matte	28.00
1963.05	Gold	25.00
1963.07	White	19.90
1963.15	Nickel matte	28.00



Recessed spotlight, GU10

Including bracket with GU10 holder for standard-compliant strain relief.

Illuminants: For LED retrofit lamp, model: GU10, Power: maximum 50 W, material: Cast

Item no.	Color	Price €
36141020	Chromium	33.00
36141030	Chromium matte	39.00
36141050	Gold	36.00
36141070	White	30.90
36141150	Nickel matte	39.00



LED recessed spotlight set, switchable

Set including converter for 230 V mains voltage, switchable, dimensions of converter: L 68 x W 35 x H 21 mm

Illuminants: LED, color rendering: CRI > 80, power: 6 W, beam angle: 38°, material: Cast / Aluminum / Glass / Plastic

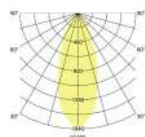

Item no.	Color	Luminous flux	Color temperature	Price €
38141023	Chromium	680 lm	3000 K	97.60
38141033	Chromium matte	680 lm	3000 K	103.30
38141053	Gold	680 lm	3000 K	100.30
38141073	White	680 lm	3000 K	95.20
38141153	Nickel matte	680 lm	3000 K	103.30



LED recessed spotlight set, dimmable phase section

NEW

Set including converter for 230 V mains voltage, dimmable phase section, dimensions of converter: L 110 x W 50 x H 19 mm

Illuminants: LED, color rendering: CRI > 80, power: 6 W, beam angle: 38°, material: Cast / Aluminum / Glass / Plastic

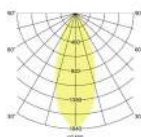

Item no.	Color	Luminous flux	Color temperature	Price €
39141023	NEW Chromium	680 lm	3000 K	101.20
39141033	NEW Chromium matte	680 lm	3000 K	107.20
39141053	NEW Gold	680 lm	3000 K	104.20
39141073	NEW White	680 lm	3000 K	99.10
39141153	NEW Nickel matte	680 lm	3000 K	107.20

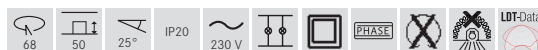

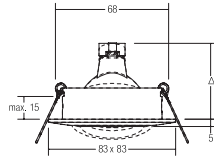

Recessed spotlight, GX5.3

Illuminants: For LED retrofit lamp, model: GX5.3, power: maximum 50 W, material: Cast, delivery: including holder with 300 mm feed line, without circlip

Item no.	Color	Price €
1964.02	Chromium	25.50
1964.03	Chromium matte	29.90
1964.05	Gold	27.50
1964.07	White	23.90
1964.15	Nickel matte	29.50



Recessed spotlight, GU10

Including bracket with GU10 holder for standard-compliant strain relief.

Illuminants: For LED retrofit lamp, model: GU10, Power: maximum 50 W, material: Cast

Item no.	Color	Price €
36142020	Chromium	36.50
36142030	Chromium matte	41.90
36142050	Gold	38.50
36142070	White	34.90
36142150	Nickel matte	40.50



LED recessed spotlight set, switchable

Set including converter for 230 V mains voltage, switchable, dimensions of converter: L 68 x W 35 x H 21 mm

Illuminants: LED, color rendering: CRI > 80, power: 6 W, beam angle: 38°, material: Cast / Aluminum / Glass / Plastic

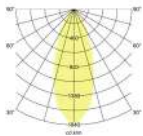

Item no.	Color	Luminous flux	Color temperature	Price €
38142023	Chromium	680 lm	3000 K	100.80
38142033	Chromium matte	680 lm	3000 K	105.20
38142053	Gold	680 lm	3000 K	102.80
38142073	White	680 lm	3000 K	99.20
38142153	Nickel matte	680 lm	3000 K	104.80



LED recessed spotlight set, dimmable phase section

NEW

Set including converter for 230 V mains voltage, dimmable phase section, dimensions of converter: L 110 x W 50 x H 19 mm

Illuminants: LED, color rendering: CRI > 80, power: 6 W, beam angle: 38°, material: Cast / Aluminum / Glass / Plastic

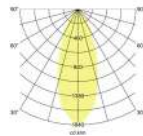

Item no.	Color	Luminous flux	Color temperature	Price €
39142023	NEW Chromium	680 lm	3000 K	104.70
39142033	NEW Chromium matte	680 lm	3000 K	109.10
39142053	NEW Gold	680 lm	3000 K	106.70
39142073	NEW White	680 lm	3000 K	103.10
39142153	NEW Nickel matte	680 lm	3000 K	108.70

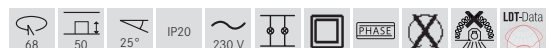

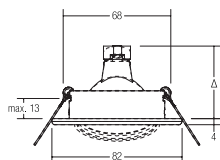

Recessed spotlight, GX5.3

Illuminants: For LED retrofit lamp, model: GX5.3, power: maximum 50 W, material: Steel / Brass

Item no.	Color	Price €
2034.02	Chromium	18.50
2034.03	Chromium matte	23.90
2034.05	Gold	19.50
2034.07	White	13.20
2034.08	Black	15.60



Recessed spotlight, GU10

Including bracket with GU10 holder for standard-compliant strain relief.

Illuminants: For LED retrofit lamp, model: GU10, Power: maximum 50 W, material: Steel / Brass

Item no.	Color	Price €
36180020	Chromium	29.50
36180030	Chromium matte	34.90
36180050	Gold	30.50
36180070	White	24.20
36180080	Black	26.60



LED recessed spotlight set, switchable

Set including converter for 230 V mains voltage, switchable, dimensions of converter: L 68 x W 35 x H 21 mm

Illuminants: LED, color rendering: CRI > 80, power: 6 W, beam angle: 38°, material: Steel / Brass / Aluminum / Glass / Plastic

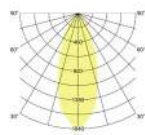

Item no.	Color	Luminous flux	Color temperature	Price €
38180023	Chromium	680 lm	3000 K	93.80
38180033	Chromium matte	680 lm	3000 K	99.20
38180053	Gold	680 lm	3000 K	94.80
38180073	White	680 lm	3000 K	88.50
38180083	Black	680 lm	3000 K	90.90



LED recessed spotlight set, dimmable phase section

NEW

Set including converter for 230 V mains voltage, dimmable phase section, dimensions of converter: L 110 x W 50 x H 19 mm

Illuminants: LED, color rendering: CRI > 80, power: 6 W, beam angle: 38°, material: Steel / Brass / Aluminum / Glass / Plastic

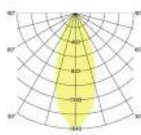

Item no.	Color	Luminous flux	Color temperature	Price €
39180023	NEW Chromium	680 lm	3000 K	97.70
39180033	NEW Chromium matte	680 lm	3000 K	103.10
39180053	NEW Gold	680 lm	3000 K	98.70
39180073	NEW White	680 lm	3000 K	92.40
39180083	NEW Black	680 lm	3000 K	94.80



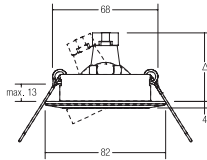

Recessed spotlight, GX5.3

Illuminants: For LED retrofit lamp, model: GX5.3, power: maximum 50 W, material: Aluminum

Item no.	Color	Price €
2169.02	Chromium	21.20
2169.03	Chromium matte	23.80
2169.07	White	15.30



Recessed spotlight, GU10

Including bracket with GU10 holder for standard-compliant strain relief.

Illuminants: For LED retrofit lamp, model: GU10, power: maximum 50 W, material: Aluminum

Item no.	Color	Price €
36303020	Chromium	32.20
36303030	Chromium matte	34.80
36303070	White	26.30



LED recessed spotlight set, switchable

Set including converter for 230 V mains voltage, switchable, dimensions of converter: L 68 x W 35 x H 21 mm

Illuminants: LED, color rendering: CRI > 80, power: 6 W, beam angle: 38°, material: Aluminum / Glass / Plastic

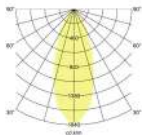

Item no.	Color	Luminous flux	Color temperature	Price €
38303023	Chromium	680 lm	3000 K	96.50
38303033	Chromium matte	680 lm	3000 K	99.10
38303073	White	680 lm	3000 K	90.60



LED recessed spotlight set, dimmable phase section

NEW

Set including converter for 230 V mains voltage, dimmable phase section, dimensions of converter: L 100 x W 50 x H 19 mm

Illuminants: LED, color rendering: CRI > 80, power: 6 W, beam angle: 38°, material: Aluminum / Glass / Plastic

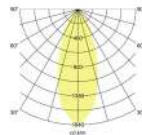

Item no.	Color	Luminous flux	Color temperature	Price €
39303023	NEW Chromium	680 lm	3000 K	100.40
39303033	NEW Chromium matte	680 lm	3000 K	103.00
39303073	NEW White	680 lm	3000 K	94.50



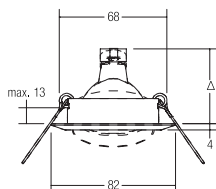

Recessed spotlight, GX5.3

Illuminants: For LED retrofit lamp, model: GX5.3,
Power: maximum 50 W, material: Steel

Item no.	Color	Price €
2295.02	Chromium	15.80
2295.07	White	11.80
2295.15	Nickel matte	16.80



Recessed spotlight, GU10

Including bracket with GU10 holder for standard-compliant strain relief.
Illuminants: For LED retrofit lamp, model: GU10,
Power: maximum 50 W, material: Steel

Item no.	Color	Price €
36304020	Chromium	26.80
36304070	White	22.80
36304150	Nickel matte	27.80



LED recessed spotlight set, switchable

Set including converter for 230 V mains voltage, switchable,
dimensions of converter: L 68 x W 35 x H 21 mm

Illuminants: LED, color rendering: CRI > 80, power: 6 W,
beam angle: 38°, material: Steel / Aluminum / Glass / Plastic

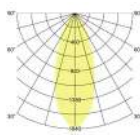

Item no.	Color	Luminous flux	Color temperature	Price €
38304023	Chromium	680 lm	3000 K	91.10
38304073	White	680 lm	3000 K	87.10
38304153	Nickel matte	680 lm	3000 K	92.10



LED recessed spotlight set, dimmable phase section

NEW

Set including converter for 230 V mains voltage, dimmable phase section,
dimensions of converter: L 110 x W 50 x H 19 mm

Illuminants: LED, color rendering: CRI > 80, power: 6 W,
beam angle: 38°, material: Steel / Aluminum / Glass / Plastic

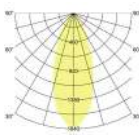

Item no.	Color	Luminous flux	Color temperature	Price €
39304023	NEW Chromium	680 lm	3000 K	95.00
39304073	NEW White	680 lm	3000 K	91.00
39304153	NEW Nickel matte	680 lm	3000 K	96.00



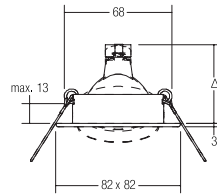

Recessed spotlight, GX5.3

Illuminants: For LED retrofit lamp, model: GX5.3, power: maximum 50 W, material: Steel

Item no.	Color	Price €
2296.02	Chromium	16.60
2296.07	White	12.90
2296.15	Nickel matte	17.60



Recessed spotlight, GU10

Including bracket with GU10 holder for standard-compliant strain relief.

Illuminants: For LED retrofit lamp, model: GU10, power: maximum 50 W, material: Steel

Item no.	Color	Price €
36305020	Chromium	27.60
36305070	White	23.90
36305150	Nickel matte	28.60



LED recessed spotlight set, switchable

Set including converter for 230 V mains voltage, switchable, dimensions of converter: L 68 x W 35 x H 21 mm

Illuminants: LED, color rendering: CRI > 80, power: 6 W, beam angle: 38°, material: Steel / Aluminum / Glass / Plastic

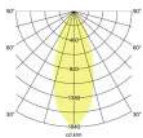

Item no.	Color	Luminous flux	Color temperature	Price €
38305023	Chromium	680 lm	3000 K	91.90
38305073	White	680 lm	3000 K	88.20
38305153	Nickel matte	680 lm	3000 K	92.90



LED recessed spotlight set, dimmable phase section

NEW

Set including converter for 230 V mains voltage, dimmable phase section, dimensions of converter: L 110 x W 50 x H 19 mm

Illuminants: LED, color rendering: CRI > 80, power: 6 W, beam angle: 38°, material: Steel / Aluminum / Glass / Plastic

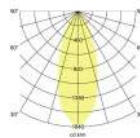

Item no.	Color	Luminous flux	Color temperature	Price €
39305023	NEW Chromium	680 lm	3000 K	95.80
39305073	NEW White	680 lm	3000 K	92.10
39305153	NEW Nickel matte	680 lm	3000 K	96.80



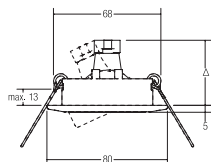

Recessed spotlight, GX5.3

Illuminants: For LED retrofit lamp, model: GX5.3,
Power: maximum 50 W, material: Steel

Item no.	Color	Price €
1925.02	Chromium	22.20
1925.07	White	20.70
1925.15	Nickel matte	28.60
1925.22	Stainless steel*	41.80



Luminaire marked with *: Material: Stainless steel

Recessed spotlight, GU10

Including bracket with GU10 holder for standard-compliant strain relief.

Illuminants: For LED retrofit lamp, model: GU10,
Power: maximum 50 W, material: Steel

Item no.	Color	Price €
36145020	Chromium	33.20
36145070	White	31.70
36145150	Nickel matte	39.60
36145220	Stainless steel*	52.80



Luminaire marked with *: Material: Stainless steel

LED recessed spotlight set, switchable

Set including converter for 230 V mains voltage, switchable,
dimensions of converter: L 68 x W 35 x H 21 mm

Illuminants: LED, color rendering: CRI > 80, power: 6 W,
beam angle: 38°, material: Steel / Aluminum / Glass / Plastic

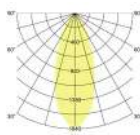

Item no.	Color	Luminous flux	Color temperature	Price €
38145023	Chromium	680 lm	3000 K	97.50
38145073	White	680 lm	3000 K	96.00
38145153	Nickel matte	680 lm	3000 K	103.90
38145223	Stainless steel*	680 lm	3000 K	117.10



Luminaire marked with *: Material: Stainless steel / Aluminum / Glass / Plastic

LED recessed spotlight set, dimmable phase section

NEW

Set including converter for 230 V mains voltage, dimmable phase section,
dimensions of converter: L 110 x W 50 x H 19 mm

Illuminants: LED, color rendering: CRI > 80, power: 6 W,
beam angle: 38°, material: Steel / Aluminum / Glass / Plastic

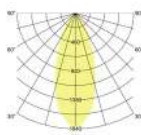

Item no.	Color	Luminous flux	Color temperature	Price €
39145023	NEW Chromium	680 lm	3000 K	101.40
39145073	NEW White	680 lm	3000 K	99.90
39145153	NEW Nickel matte	680 lm	3000 K	107.80
39145223	NEW Stainless steel*	680 lm	3000 K	121.00



Luminaire marked with *: Material: Stainless steel / Aluminum / Glass / Plastic

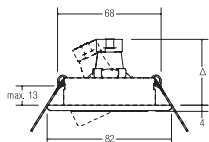

Recessed spotlight, GX5.3

Illuminants: For LED retrofit lamp, model: GX5.3, power: maximum 50 W, material: Steel

Item no.	Color	Price €
1996.02	Chromium	24.50
1996.07	White	21.50
1996.15	Nickel matte	31.00
1996.22	Stainless steel*	45.90



Luminaire marked with *: Material: Stainless steel

LED recessed spotlight set, switchable

Set including converter for 230 V mains voltage, switchable, dimensions of converter: L 68 x W 35 x H 21 mm

Illuminants: LED, color rendering: CRI > 80, power: 6 W, beam angle: 38°, material: Steel / Aluminum / Glass / Plastic

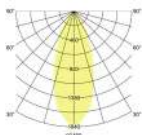

Item no.	Color	Luminous flux	Color temperature	Price €
38182023	Chromium	680 lm	3000 K	99.80
38182073	White	680 lm	3000 K	96.80
38182153	Nickel matte	680 lm	3000 K	106.30
38182223	Stainless steel*	680 lm	3000 K	120.70



Luminaire marked with *: Material: Stainless steel / Aluminum / Glass / Plastic

Recessed spotlight, GZ10

Including bracket with GZ10 holder for standard-compliant strain relief.

Illuminants: For LED retrofit lamp, model: GZ10, power: maximum 50 W, material: Steel

Item no.	Color	Price €
H1996.02	Chromium	35.50
H1996.07	White	32.50
H1996.15	Nickel matte	42.00
H1996.22	Stainless steel*	56.90



Luminaire marked with *: Material: Stainless steel

LED recessed spotlight set, dimmable phase section

NEW

Set including converter for 230 V mains voltage, dimmable phase section, dimensions of converter: L 110 x W 50 x H 19 mm

Illuminants: LED, color rendering: CRI > 80, power: 6 W, beam angle: 38°, material: Steel / Aluminum / Glass / Plastic

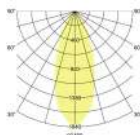

Item no.	Color	Luminous flux	Color temperature	Price €
39182023	NEW Chromium	680 lm	3000 K	103.70
39182073	NEW White	680 lm	3000 K	100.70
39182153	NEW Nickel matte	680 lm	3000 K	110.20
39182223	NEW Stainless steel*	680 lm	3000 K	125.10

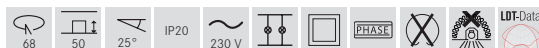

Luminaire marked with *: Material: Stainless steel / Aluminum / Glass / Plastic



Recessed spotlight, GX5.3

Illuminants: For LED retrofit lamp, model: GX5.3,
Power: maximum 50 W, material: Stainless steel

Item no.	Color	Price €
2191.07	White	26.70
2191.20	Clear powder-coated stainless steel	26.70
2191.22	Stainless steel	24.30



Recessed spotlight, GZ10

Including bracket with GZ10 holder for standard-compliant strain relief.

Illuminants: For LED retrofit lamp, model: GZ10,
Power: maximum 50 W, material: Stainless steel

Item no.	Color	Price €
H2191.07	White	37.70
H2191.20	Clear powder-coated stainless steel	37.70
H2191.22	Stainless steel	35.30

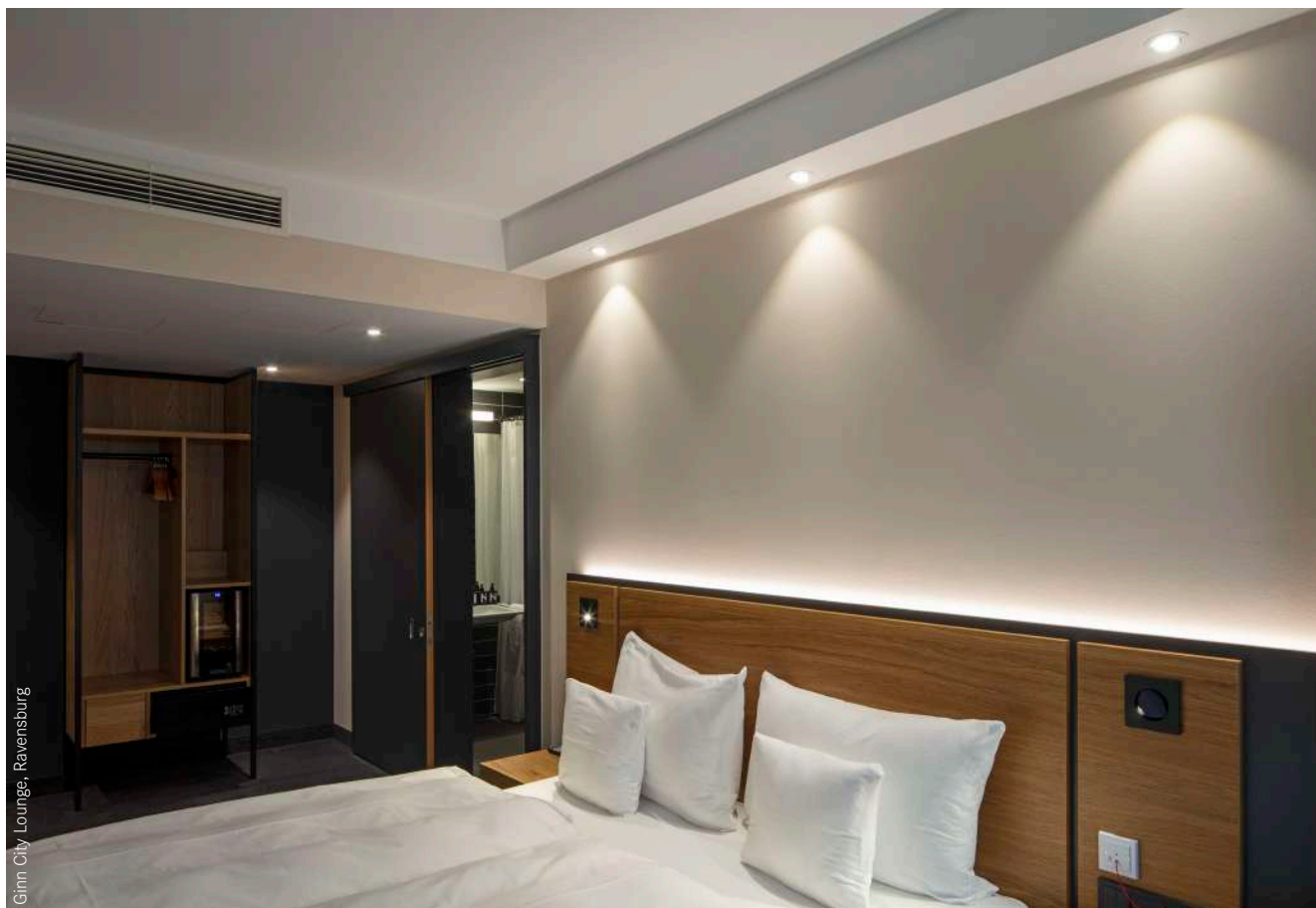

Ginn City Lounge, Ravensburg



BB09 LED recessed spotlight set, switchable

Set including converter for 230 V mains voltage, switchable, dimensions of converter: L 68 x W 35 x H 21 mm

Illuminants: LED, color rendering: CRI > 80, power: 6 W, beam angle: 38°, material: Stainless steel / Aluminum / Plastic

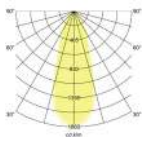

Item no.	Color	Luminous flux	Color temperature	Price €
38369073	White	640 lm	3000 K	44.50
38369223	Stainless steel	640 lm	3000 K	47.60



BB09 LED recessed spotlight set, dimmable phase section

Set including converter for 230 V mains voltage, dimmable phase section, dimensions of converter: L 110 x W 50 x H 19 mm

Illuminants: LED, color rendering: CRI > 80, power: 6 W, beam angle: 38°, material: Stainless steel / Aluminum / Plastic

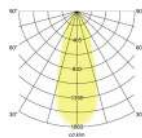

Item no.	Color	Luminous flux	Color temperature	Price €
39369073	White	640 lm	3000 K	49.30
39369223	Stainless steel	640 lm	3000 K	52.60



BB09 LED recessed spotlight set, dimmable phase section (round converter)

Set including converter for 230 V mains voltage, dimmable phase section, dimensions of converter: D 51 x H 24 mm

Illuminants: LED, color rendering: CRI > 80, power: 6 W, beam angle: 38°, material: Stainless steel / Aluminum / Plastic

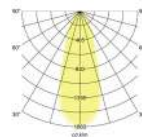

Item no.	Color	Luminous flux	Color temperature	Price €
40369073	White	640 lm	3000 K	58.10
40369223	Stainless steel	640 lm	3000 K	61.40



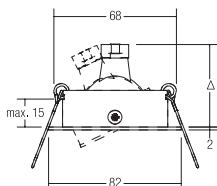

Recessed spotlight, V4A, GX5.3

Illuminants: For LED retrofit lamp, model: GX5.3, power: maximum 50 W, material: Stainless steel V4A, delivery: without circlip

Item no.	Color	Price €
1180.22	Stainless steel	79.00



Recessed spotlight, V4A, GU10

Including bracket with GU10 holder for standard-compliant strain relief.
Illuminants: For LED retrofit lamp, model: GU10, power: maximum 50 W, material: Stainless steel V4A

Item no.	Color	Price €
36147220	Stainless steel	90.00



LED recessed spotlight set V4A, switchable

Set including converter for 230 V mains voltage, switchable, dimensions of converter: L 68 x W 35 x H 21 mm

Illuminants: LED, color rendering: CRI > 80, power: 6 W, beam angle: 38°, material: Stainless steel V4A / Aluminum / Glass / Plastic

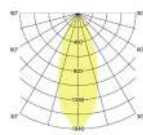

Item no.	Color	Luminous flux	Color temperature	Price €
38147223	Stainless steel	680 lm	3000 K	154.30

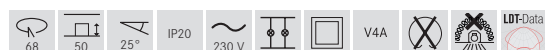

LED recessed spotlight set, V4A, dimmable phase section

NEW

Set including converter for 230 V mains voltage, dimmable phase section, dimensions of converter: L 110 x W 50 x H 19 mm

Illuminants: LED, color rendering: CRI > 80, power: 6 W, beam angle: 38°, material: Stainless steel V4A / Aluminum / Glass / Plastic

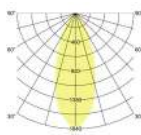

Item no.	Color	Luminous flux	Color temperature	Price €
39147223	NEW Stainless steel	680 lm	3000 K	158.20

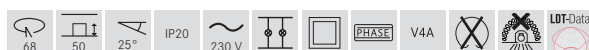

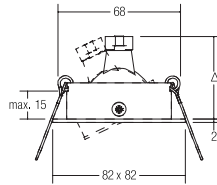

Recessed spotlight, V4A, GX5.3

Illuminants: For LED retrofit lamp, model: GX5.3, power: maximum 50 W, material: Stainless steel V4A, delivery: without circlip

Item no.	Color	Price €
1181.22	Stainless steel	84.30

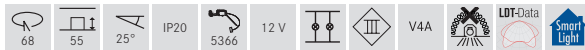

Recessed spotlight, V4A, GU10

Including bracket with GU10 holder for standard-compliant strain relief.

Illuminants: For LED retrofit lamp, model: GU10, power: maximum 50 W, material: Stainless steel V4A

Item no.	Color	Price €
36148220	Stainless steel	95.30



LED recessed spotlight set V4A, switchable

Set including converter for 230 V mains voltage, switchable, dimensions of converter: L 68 x W 35 x H 21 mm

Illuminants: LED, color rendering: CRI > 80, power: 6 W, beam angle: 38°, material: Stainless steel V4A / Aluminum / Glass / Plastic

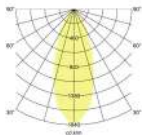

Item no.	Color	Luminous flux	Color temperature	Price €
38148223	Stainless steel	680 lm	3000 K	159.60

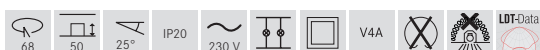

LED recessed spotlight set, V4A, dimmable phase section

NEW

Set including converter for 230 V mains voltage, dimmable phase section, dimensions of converter: L 110 x W 50 x H 19 mm

Illuminants: LED, color rendering: CRI > 80, power: 6 W, beam angle: 38°, material: Stainless steel V4A / Aluminum / Glass / Plastic

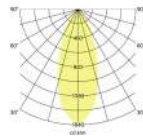

Item no.	Color	Luminous flux	Color temperature	Price €
39148223	NEW Stainless steel	680 lm	3000 K	163.50

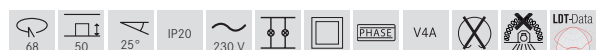

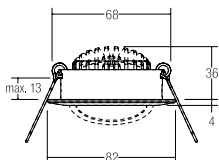

BB03 LED recessed spotlight set, switchable

Set including converter for 230 V mains voltage, switchable, dimensions of converter: L 68 x W 35 x H 21 mm

Illuminants: LED, color rendering: CRI > 80, power: 6 W, beam angle: 38°, material: Aluminum / Plastic

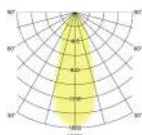

Item no.	Color	Luminous flux	Color temperature	Price €
38363023	Chromium	640 lm	3000 K	44.50
38363073	White	640 lm	3000 K	41.30
38363153	Nickel matte	640 lm	3000 K	44.50



BB03 LED recessed spotlight set, dimmable phase section

Set including converter for 230 V mains voltage, dimmable phase section, dimensions of converter: L 110 x W 50 x H 19 mm

Illuminants: LED, color rendering: CRI > 80, power: 6 W, beam angle: 38°, material: Aluminum / Plastic

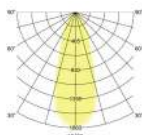

Item no.	Color	Luminous flux	Color temperature	Price €
39363023	Chromium	640 lm	3000 K	46.50
39363073	White	640 lm	3000 K	43.40
39363153	Nickel matte	640 lm	3000 K	46.50



BB03 LED recessed spotlight set, dimmable phase section, with connection box

NEW

Set including converter for 230 V mains voltage, dimmable phase section, dimensions of converter: L 110 x W 50 x H 19 mm

Illuminants: LED, color rendering: CRI > 80, power: 6 W, beam angle: 38°, material: Aluminum / Plastic, delivery: including connection box, 3-pin

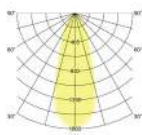

Item no.	Color	Luminous flux	Color temperature	Price €
39463023	NEW Chromium	640 lm	3000 K	55.00
39463073	NEW White	640 lm	3000 K	51.80
39463153	NEW Nickel matte	640 lm	3000 K	55.00



BB03 LED recessed spotlight set, dimmable phase section (round converter)

Set including converter for 230 V mains voltage, dimmable phase section, dimensions of converter: D 51 x H 24 mm

Illuminants: LED, color rendering: CRI > 80, power: 6 W, beam angle: 38°, material: Aluminum / Plastic

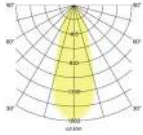

Item no.	Color	Luminous flux	Color temperature	Price €
40363023	Chromium	640 lm	3000 K	58.00
40363073	White	640 lm	3000 K	54.80
40363153	Nickel matte	640 lm	3000 K	58.00



BB03 LED recessed spotlight, DALI dimmable, with connection box

NEW

Set including converter for 230 V mains voltage, dimmable DALI-2, dimensions of converter: L 130 x W 42 x H 22 mm

Illuminants: LED, color rendering: CRI > 80, power: 6 W, beam angle: 38°, material: Aluminum / Plastic, delivery: including connection box, 5-pin

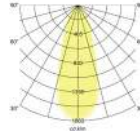

Item no.	Color	Luminous flux	Color temperature	Price €
41463023	NEW Chromium	640 lm	3000 K	88.80
41463073	NEW White	640 lm	3000 K	85.80
41463153	NEW Nickel matte	640 lm	3000 K	88.80



Leaf spring set for BB sets BB03 / BB05

NEW

Leaf spring set consisting of 2 pieces of leaf springs for on-site equipment (replacement of the standard leg spring) of the BB sets 03 and 05.

Item no.	Price €
532700 NEW	1.80

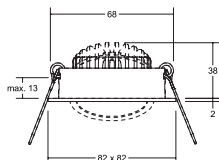

BB05 LED recessed spotlight set, switchable

Set including converter for 230 V mains voltage, switchable, dimensions of converter: L 68 x W 35 x H 21 mm

Illuminants: LED, color rendering: CRI > 80, power: 6 W, beam angle: 38°, material: Aluminum / Plastic

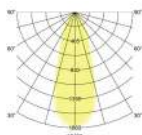

Item no.	Color	Luminous flux	Color temperature	Price €
38365023	Chromium	640 lm	3000 K	46.50
38365073	White	640 lm	3000 K	42.40
38365153	Nickel matte	640 lm	3000 K	46.50



BB05 LED recessed spotlight set, dimmable phase section

Set including converter for 230 V mains voltage, dimmable phase section, dimensions of converter: L 110 x W 50 x H 19 mm

Illuminants: LED, color rendering: CRI > 80, power: 6 W, beam angle: 38°, material: Aluminum / Plastic

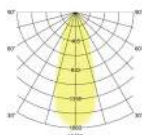

Item no.	Color	Luminous flux	Color temperature	Price €
39365023	Chromium	640 lm	3000 K	48.60
39365073	White	640 lm	3000 K	44.50
39365153	Nickel matte	640 lm	3000 K	48.60



BB05 LED recessed spotlight set, dimmable phase section, with connection box NEW

Set including converter for 230 V mains voltage, dimmable phase section, dimensions of converter: L 110 x W 50 x H 19 mm

Illuminants: LED, color rendering: CRI > 80, power: 6 W, beam angle: 38°, material: Aluminum / Plastic, delivery: including connection box, 3-pin

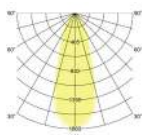

Item no.	Color	Luminous flux	Color temperature	Price €
39465023	NEW Chromium	640 lm	3000 K	57.10
39465073	NEW White	640 lm	3000 K	52.80
39465153	NEW Nickel matte	640 lm	3000 K	57.10



BB05 LED recessed spotlight set, dimmable phase section (round converter)

Set including converter for 230 V mains voltage, dimmable phase section, dimensions of converter: D 51 x H 24 mm

Illuminants: LED, color rendering: CRI > 80, power: 6 W, beam angle: 38°, material: Aluminum / Plastic

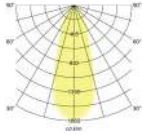

Item no.	Color	Luminous flux	Color temperature	Price €
40365023	Chromium	640 lm	3000 K	60.00
40365073	White	640 lm	3000 K	55.80
40365153	Nickel matte	640 lm	3000 K	60.00



BB05 LED recessed spotlight, DALI dimmable, with connection box

NEW

Set including converter for 230 V mains voltage, dimmable DALI-2, dimensions of converter: L 130 x W 42 x H 22 mm

Illuminants: LED, color rendering: CRI > 80, power: 6 W, beam angle: 38°, material: Aluminum / Plastic, delivery: including connection box, 5-pin

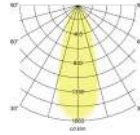

Item no.	Color	Luminous flux	Color temperature	Price €
41465023	NEW Chromium	640 lm	3000 K	90.80
41465073	NEW White	640 lm	3000 K	86.80
41465153	NEW Nickel matte	640 lm	3000 K	90.80



Leaf spring set for BB sets BB03 / BB05

NEW

Leaf spring set consisting of 2 pieces of leaf springs for on-site equipment (replacement of the standard leg spring) of the BB sets 03 and 05.

Item no.	Price €
532700 NEW	1.80



BB33 LED recessed spotlight set, switchable NEW

Set including converter for 230 V mains voltage, switchable, dimensions of converter: L 68 x W 35 x H 21 mm

Illuminants: LED, color rendering: CRI > 80, power: 7 W, beam angle: 40°, material: Aluminum / Plastic

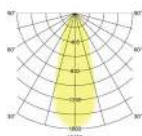

Item no.	Color	Luminous flux	Color temperature	Price €
38377173	NEW Structural white	680 lm	3000 K	46.30
38377183	NEW Structural black	680 lm	3000 K	46.30



BB33 LED recessed spotlight set, dimmable phase section NEW

Set including converter for 230 V mains voltage, dimmable phase section, dimensions of converter: L 110 x W 50 x H 19 mm

Illuminants: LED, color rendering: CRI > 80, power: 7 W, beam angle: 40°, material: Aluminum / Plastic

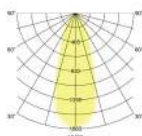

Item no.	Color	Luminous flux	Color temperature	Price €
39377173	NEW Structural white	680 lm	3000 K	48.40
39377183	NEW Structural black	680 lm	3000 K	48.40



BB33 LED recessed spotlight set, dimmable phase section (round converter) NEW

Set including converter for 230 V mains voltage, dimmable phase section, dimensions of converter: D 51 x H 24 mm

Illuminants: LED, color rendering: CRI > 80, power: 7 W, beam angle: 40°, material: Aluminum / Plastic

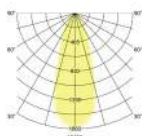

Item no.	Color	Luminous flux	Color temperature	Price €
40377173	NEW Structural white	680 lm	3000 K	56.70
40377183	NEW Structural black	680 lm	3000 K	56.70



BB33 LED recessed spotlight, DALI dimmable, with connection box NEW

Set including converter for 230 V mains voltage, dimmable DALI-2, dimensions of converter: L 130 x W 42 x H 22 mm

Illuminants: LED, color rendering: CRI > 80, power: 7 W, beam angle: 40°, material: Aluminum / Plastic, delivery: including connection box, 5-pin

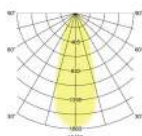

Item no.	Color	Luminous flux	Color temperature	Price €
41477173	NEW Structural white	680 lm	3000 K	89.00
41477183	NEW Structural black	680 lm	3000 K	89.00



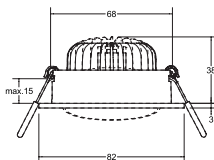

BB34 LED recessed spotlight set, switchable NEW

Set including converter for 230 V mains voltage, switchable, dimensions of converter: L 68 x W 35 x H 21 mm

Illuminants: LED, color rendering: CRI > 80, power: 7 W, beam angle: 40°, material: Aluminum / Plastic

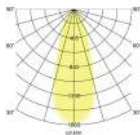

Item no.	Color	Luminous flux	Color temperature	Price €
38378173	NEW Structural white	680 lm	3000 K	46.30
38378183	NEW Structural black	680 lm	3000 K	46.30



BB34 LED recessed spotlight set, dimmable phase section NEW

Set including converter for 230 V mains voltage, dimmable phase section, dimensions of converter: L 110 x W 50 x H 19 mm

Illuminants: LED, color rendering: CRI > 80, power: 7 W, beam angle: 40°, material: Aluminum / Plastic

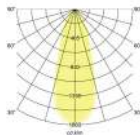

Item no.	Color	Luminous flux	Color temperature	Price €
39378173	NEW Structural white	680 lm	3000 K	48.40
39378183	NEW Structural black	680 lm	3000 K	48.40



BB34 LED recessed spotlight set, dimmable phase section (round converter) NEW

Set including converter for 230 V mains voltage, dimmable phase section, dimensions of converter: D 51 x H 24 mm

Illuminants: LED, color rendering: CRI > 80, power: 7 W, beam angle: 40°, material: Aluminum / Plastic

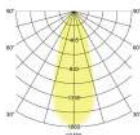

Item no.	Color	Luminous flux	Color temperature	Price €
40378173	NEW Structural white	680 lm	3000 K	56.70
40378183	NEW Structural black	680 lm	3000 K	56.70



BB34 LED recessed spotlight, DALI dimmable, with connection box NEW

Set including converter for 230 V mains voltage, dimmable DALI-2, dimensions of converter: L 130 x W 42 x H 22 mm

Illuminants: LED, color rendering: CRI > 80, power: 7 W, beam angle: 40°, material: Aluminum / Plastic, delivery: including connection box, 5-pin

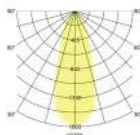

Item no.	Color	Luminous flux	Color temperature	Price €
41478173	NEW Structural white	680 lm	3000 K	89.00
41478183	NEW Structural black	680 lm	3000 K	89.00



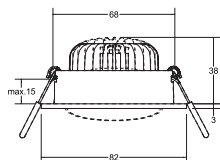

BB35 LED recessed spotlight set, switchable

NEW

Set including converter for 230 V mains voltage, switchable, dimensions of converter: L 68 x W 35 x H 21 mm

Illuminants: LED, color rendering: CRI > 80, power: 7 W, beam angle: 40°, material: Aluminum / Plastic

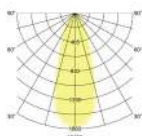

Item no.	Color	Luminous flux	Color temperature	Price €
38379173 NEW	Structural white	680 lm	3000 K	46.30
38379183 NEW	Structural black	680 lm	3000 K	46.30



BB35 LED recessed spotlight set, dimmable phase section

NEW

Set including converter for 230 V mains voltage, dimmable phase section, dimensions of converter: L 110 x W 50 x H 19 mm

Illuminants: LED, color rendering: CRI > 80, power: 7 W, beam angle: 40°, material: Aluminum / Plastic

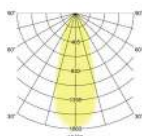

Item no.	Color	Luminous flux	Color temperature	Price €
39379173 NEW	Structural white	680 lm	3000 K	48.40
39379183 NEW	Structural black	680 lm	3000 K	48.40



BB35 LED recessed spotlight set, dimmable phase section (round converter)

NEW

Set including converter for 230 V mains voltage, dimmable phase section, dimensions of converter: D 51 x H 24 mm

Illuminants: LED, color rendering: CRI > 80, power: 7 W, beam angle: 40°, material: Aluminum / Plastic

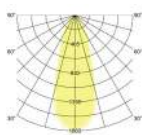

Item no.	Color	Luminous flux	Color temperature	Price €
40379173 NEW	Structural white	680 lm	3000 K	56.70
40379183 NEW	Structural black	680 lm	3000 K	56.70



BB35 LED recessed spotlight, DALI dimmable, with connection box

NEW

Set including converter for 230 V mains voltage, dimmable DALI-2, dimensions of converter: L 130 x W 42 x H 22 mm

Illuminants: LED, color rendering: CRI > 80, power: 7 W, beam angle: 40°, material: Aluminum / Plastic, Delivery: including connection box, 5-pin

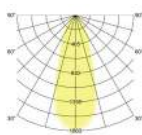

Item no.	Color	Luminous flux	Color temperature	Price €
41479173 NEW	Structural white	680 lm	3000 K	89.00
41479183 NEW	Structural black	680 lm	3000 K	89.00





Private house, Norderstedt

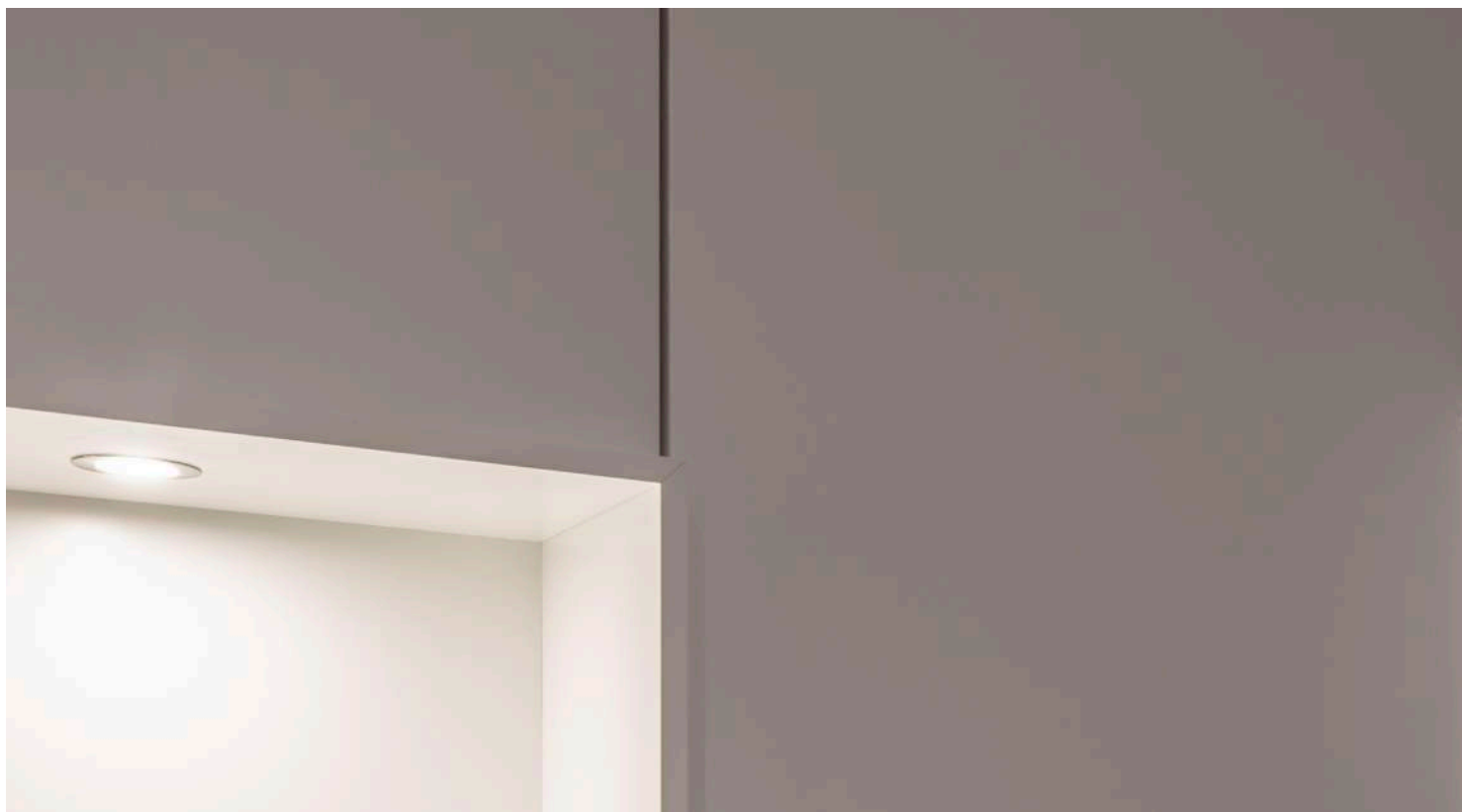

BB18 LED recessed spotlight set, dim2warm, dimmable phase section, with connection box NEW

BB19 LED recessed spotlight set, dim2warm, dimmable phase section, with connection box NEW

If the luminaire is dimmed, the color temperature reduces.
Set including converter for 230 V mains voltage, dimmable phase section, dimensions of converter: L 110 x W 50 x H 19 mm

If the luminaire is dimmed, the color temperature reduces.
Set including converter for 230 V mains voltage, dimmable phase section, dimensions of converter: L 110 x W 50 x H 19 mm

Illuminants: LED, color rendering: CRI > 80, power: 6 W, beam angle: 38°, material: Aluminum / Glass / Plastic, Delivery: including connection box, 3-pin

Illuminants: LED, color rendering: CRI > 80, power: 6 W, beam angle: 38°, material: Aluminum / Glass / Plastic, Delivery: including connection box, 3-pin

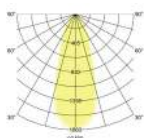
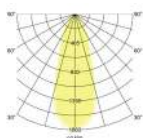

Item no.	Color	Luminous flux	Color temperature	Price €
39483023 NEW	Chromium	460 lm	3000 K - 1800 K	78.00
39483073 NEW	White	460 lm	3000 K - 1800 K	76.90
39483083 NEW	Black	460 lm	3000 K - 1800 K	76.90
39483253 NEW	Aluminum matte	460 lm	3000 K - 1800 K	76.90
39483633 NEW	Champagne matte	460 lm	3000 K - 1800 K	81.60
39483643 NEW	Titanium matte	460 lm	3000 K - 1800 K	81.60

Item no.	Color	Luminous flux	Color temperature	Price €
39485023 NEW	Chromium	460 lm	3000 K - 1800 K	80.50
39485073 NEW	White	460 lm	3000 K - 1800 K	79.40
39485083 NEW	Black	460 lm	3000 K - 1800 K	79.40
39485253 NEW	Aluminum matte	460 lm	3000 K - 1800 K	79.40
39485633 NEW	Champagne matte	460 lm	3000 K - 1800 K	84.10
39485643 NEW	Titanium matte	460 lm	3000 K - 1800 K	84.10





Private house, Coesfeld

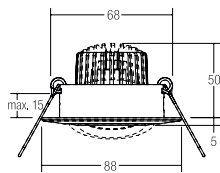

dim2warm

BB13 LED recessed spotlight set, dim2warm, dimmable phase section

If the luminaire is dimmed, the color temperature reduces.
Set including converter for 230 V mains voltage, dimmable phase section, dimensions of converter: L 110 x W 50 x H 19 mm

Illuminants: LED, color rendering: CRI > 80, power: 6 W, beam angle: 38°, material: Cast / Aluminum / Glass / Plastic

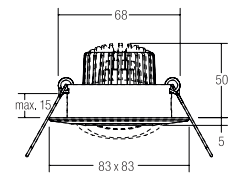
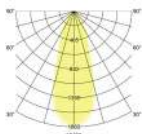

dim2warm

BB14 LED recessed spotlight set, dim2warm, dimmable phase section

If the luminaire is dimmed, the color temperature reduces.
Set including converter for 230 V mains voltage, dimmable phase section, dimensions of converter: L 110 x W 50 x H 19 mm

Illuminants: LED, color rendering: CRI > 80, power: 6 W, beam angle: 38°, material: Cast / Aluminum / Glass / Plastic

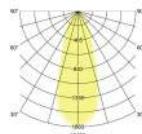

Item no.	Color	Luminous flux	Color temperature	Price €
39373023	Chromium	460 lm	3000 K - 1800 K	74.60
39373073	White	460 lm	3000 K - 1800 K	71.30
39373153	Nickel matte	460 lm	3000 K - 1800 K	74.60



Also available in chromium matte or gold surface on request.

Item no.	Color	Luminous flux	Color temperature	Price €
39374023	Chromium	460 lm	3000 K - 1800 K	76.80
39374073	White	460 lm	3000 K - 1800 K	74.60
39374153	Nickel matte	460 lm	3000 K - 1800 K	76.80



Also available in chromium matte or gold surface on request.

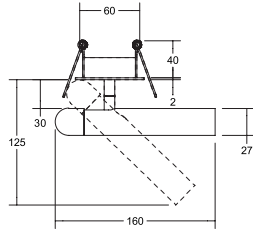

CUBA LED recessed spotlight, rotatable and swiveling

NEW

Illuminants: LED, color rendering: CRI > 90, power: 4.2 W, beam angle: 38°, material: Aluminum, delivery: including converter for connection with 230 V mains voltage, switchable



Item no.	Color	Luminous flux	Color temperature	Price €
12310173	NEW Structural white	250 lm	3000 K	123.90
12310183	NEW Structural black	250 lm	3000 K	123.90

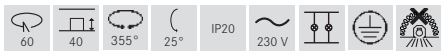

CUBA product family



CUBA LED wall surface-mounted spotlight
See page 237

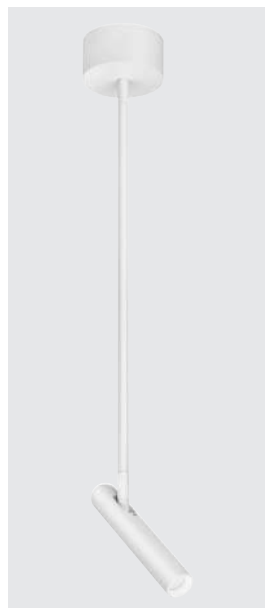

CUBA LED surface-mounted spotlight
See page 179



CUBA LED pendant luminaire
See page 198

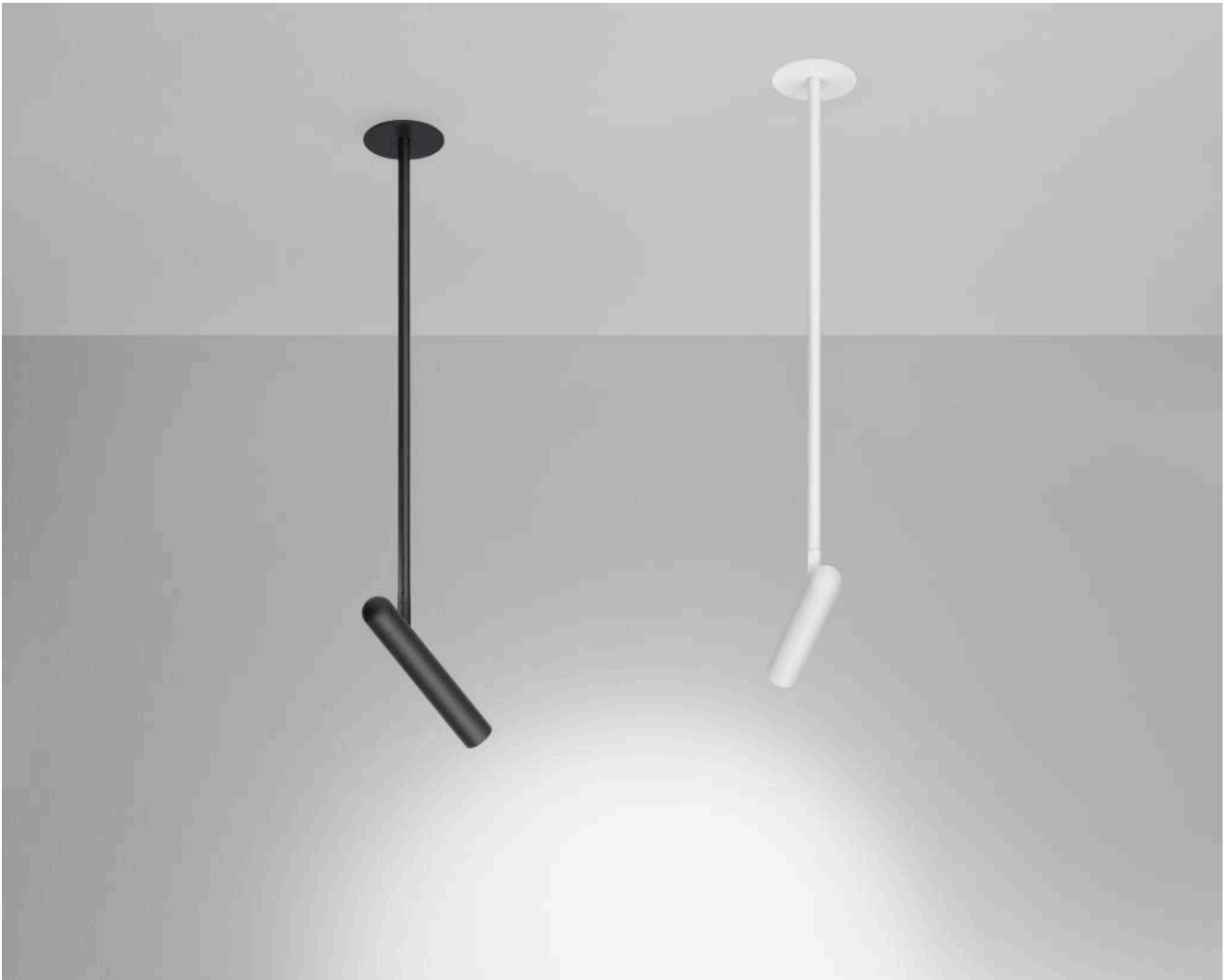

CUBA LED recessed spotlight, rotatable and swiveling

NEW

Illuminants: LED, color rendering: CRI > 90, power: 4.2 W, beam angle: 38°, material: Aluminum, delivery: including converter for connection with 230 V mains voltage, switchable

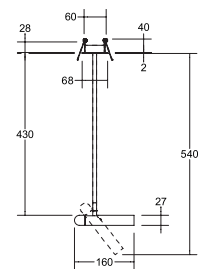

Item no.	Color	Luminous flux	Color temperature	Price €
12308173	NEW Structural white	250 lm	3000 K	138.90
12308183	NEW Structural black	250 lm	3000 K	138.90





CORE LED recessed spotlight

Illuminants: LED, color rendering: CRI > 80, power: 32 W, beam angle: 38°, material: Aluminum / Glass / Plastic, heat dissipation: passive (without fans), Rotation angle: rotatable/swiveling, dimensions of luminaire: Ø 156 mm x 130 mm, weight: 1.0 kg, mechanical installation depth depending on swivel angle (45° - 0°) from 95 mm - 130 mm. Including operating device, switchable, power factor > 0.9 (230 V AC 50 Hz)

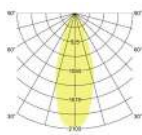

Item no.	Color	Color temperature	Luminous flux	Beam angle	Price €
88673173	White	3000 K	2,639 lm	38°	150.00
88673175	White	3500 K	2,668 lm	38°	150.00
88673174	White	4000 K	2,697 lm	38°	150.00
88673183	Black	3000 K	2,639 lm	38°	150.00
88673185	Black	3500 K	2,668 lm	38°	150.00
88673184	Black	4000 K	2,697 lm	38°	150.00



* Also available with beam angle 12°, 24° or 60° on request.



CORE LED track spotlight

Item no. 88373...
See page 252

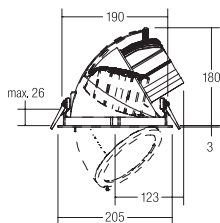

CORE LED recessed spotlight

Illuminants: LED, color rendering: CRI > 80, power: 48.9 W, beam angle: 38°, material: Aluminum / Glass, Heat dissipation: passive (without fans), Rotation angle: rotatable/swiveling, dimensions of luminaire: Ø 205 mm x 200 mm, weight: 1.7 kg, including operating device, switchable, power factor > 0.9 (230 V AC 50 Hz).

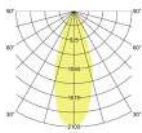

Item no.	Color	Color temperature	Luminous flux	Beam angle	Price €
88677173	White	3000 K	4,441 lm	38°	239.00
88677175	White	3500 K	4,661 lm	38°	239.00
88677174	White	4000 K	4,881 lm	38°	239.00
88677183	Black	3000 K	4,441 lm	38°	239.00
88677185	Black	3500 K	4,661 lm	38°	239.00
88677184	Black	4000 K	4,881 lm	38°	239.00



* Also available with beam angle 12°, 24° or 60° on request.



CORE LED track spotlight

Item no. 88377...
See page 253

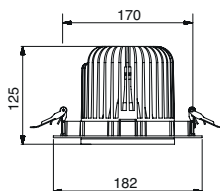

LED recessed spotlight

NEW

Illuminants: LED, input voltage: 220 - 240 V AC, 50 - 60 Hz, color rendering: CRI > 90, power: 32 W, beam angle: 30°, material: Aluminum / Glass / Plastic, heat dissipation: passive (without fans), rotation angle: can be rotated/swiveled, including operating device

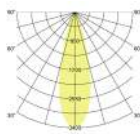

Item no.	Color	Color rendering	Color temperature	Luminous flux	Control	Price €
12590173	NEW Structural white	CRI > 90	3000 K	3,800 lm	Switchable	149.00
12590174	NEW Structural white	CRI > 90	4000 K	4,030 lm	Switchable	149.00
12592173	NEW Structural white	CRI > 90	3000 K	3,800 lm	DALI	229.00
12592174	NEW Structural white	CRI > 90	4000 K	4,030 lm	DALI	229.00
12590183	NEW Structural black	CRI > 90	3000 K	3,800 lm	Switchable	149.00
12590184	NEW Structural black	CRI > 90	4000 K	4,030 lm	Switchable	149.00
12592183	NEW Structural black	CRI > 90	3000 K	3,800 lm	DALI	229.00
12592184	NEW Structural black	CRI > 90	4000 K	4,030 lm	DALI	229.00



Available with other beam angles on request:

12° 20° 30° 40° 60°





CORE LED recessed spotlight

Illuminants: LED, color rendering: CRI > 80, power: 34.4 W, beam angle: 38°, material: Aluminum / Plastic, heat dissipation: passive (without fans), Rotation angle: rotatable/swiveling, dimensions of luminaire: L 180 mm x W 180 mm x H 150 mm, weight: 1.3 kg, including operating device, switchable, power factor > 0.9 (230 V AC 50 Hz)

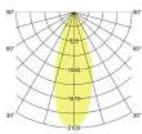

Item no.	Color	Color temperature	Luminous flux	Beam angle	Price €
88681173	White	3000 K	2,917 lm	38°	155.00
88681175	White	3500 K	3,011 lm	38°	155.00
88681174	White	4000 K	3,106 lm	38°	155.00
88681183	Black	3000 K	2,917 lm	38°	155.00
88681185	Black	3500 K	3,011 lm	38°	155.00
88681184	Black	4000 K	3,106 lm	38°	155.00



* Also available with beam angle 12°, 24° or 60° on request.



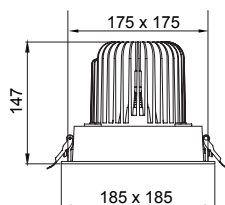

LED recessed spotlight, cardanic

NEW

Illuminants: LED, input voltage: 220 - 240 V AC, 50 - 60 Hz, color rendering: CRI > 90, power: 40 W, beam angle: 30°, material: Aluminum / Glass / Plastic, heat dissipation: passive (without fans), rotation angle: can be rotated/swiveled, including operating device

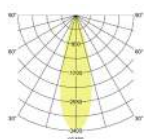

Item no.	Color	Color rendering	Luminous flux	Control	Color temperature	Price €
12581173	NEW Structural white	CRI > 90	4,300 lm	Switchable	3000 K	149.00
12581174	NEW Structural white	CRI > 90	4,560 lm	Switchable	4000 K	149.00
12583173	NEW Structural white	CRI > 90	4,300 lm	DALI	3000 K	229.00
12583174	NEW Structural white	CRI > 90	4,560 lm	DALI	4000 K	229.00
12581183	NEW Structural black	CRI > 90	4,300 lm	Switchable	3000 K	149.00
12581184	NEW Structural black	CRI > 90	4,560 lm	Switchable	4000 K	149.00
12583183	NEW Structural black	CRI > 90	4,300 lm	DALI	3000 K	229.00
12583184	NEW Structural black	CRI > 90	4,560 lm	DALI	4000 K	229.00



Available with other beam angles on request:

12° 20° 30° 40° 60°





CORE LED recessed wallwasher

Illuminants: LED, color rendering: CRI > 80, power: 45 W,
 Beam angle: 110°, material: Aluminum / Glass / Plastic,
 Passive heat dissipation (without fans), material: Aluminum / Glass,
 rotation angle: swivel, dimensions of luminaire: L 235 mm x W 145 mm
 x H 90 mm, weight: 1.1 kg, mechanical installation depth depending
 on swivel angle (45° - 0°) from 50 mm - 90 mm. Including operating
 device, switchable, power factor > 0.9 (230 V AC 50 Hz).

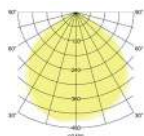

CORE LED track spotlight Wallwasher

Item no. 88387...
 See page 249

Item no.	Color	Color temperature	Luminous flux	Beam angle	Price €
88687173	White	3000 K	3,663 lm	110°	165.00
88687175	White	3500 K	3,694 lm	110°	165.00
88687174	White	4000 K	3,679 lm	110°	165.00
88687183	Black	3000 K	3,663 lm	110°	165.00
88687185	Black	3500 K	3,694 lm	110°	165.00
88687184	Black	4000 K	3,679 lm	110°	165.00





Loudspeaker insert Ø 50 mm for recessed luminaires

Nominal / music load capacity: 3 / 4 W, impedance: 20 Ohm

Up to 5 speakers can be connected in parallel to one channel of a hi-fi amplifier.

Sound pressure level: 1 W / 1 m: 82 dB (at nominal power 87 dB),
 Transmission range (-3 db): 200 - 16,000 Hz,
 Transmission range (-10 db): 150 - 20,000 Hz,
 Model: White or chromium-metallic perforated plate cover,
 Net weight: 0.06 kg

Connection using 2-core line with connecting terminal.

Material: Steel

Usable in most spots for GX5.3.

Item no.	Color	Price €
3096.02	Chromium	67.70
3096.07	White	64.60

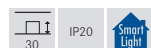

Recessed ceiling loudspeaker, DA 68 mm

Nominal / music load capacity: 3 / 4 W, impedance: 20 Ohm

Up to 5 speakers can be connected in parallel to one channel of a hi-fi amplifier.

Sound pressure level: 1 W / 1 m: 82 dB (at nominal power 87 dB),
 Transmission range (-3 db): 200 - 16,000 Hz,
 Transmission range (-10 db): 150 - 20,000 Hz,
 Model: Front ring (steel) and white or chromium-metallic perforated plate cover,
 Net weight: 0.14 kg

Installation with mounting springs.

Connection using 2-core line with connecting terminal.

Material: Steel

Item no.	Color	Price €
3093.02	Chromium	80.30
3093.07	White	76.10
3093.15	Nickel matte	87.30



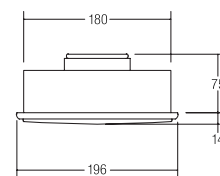
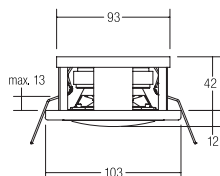

Recessed ceiling loudspeaker, DA 93 mm

Nominal / music load capacity: 6 / 8 W, impedance: 8 Ohm
 Sound pressure level: 1 W / 1 m: 86 dB (at nominal power 94 dB),
 Transmission range (-3 db): 250 - 20,000 Hz,
 Transmission range (-10 db): 170 - 21,000 Hz,
 Model: Front ring (plastic) and white perforated plate cover,
 Net weight: 0.4 kg

Installation with mounting springs.

Connection using 2-core line with connecting terminal.

Moisture impregnated membrane:
 Restricted protection from moisture.

Not suitable for continuous operation in the outdoor area.

Material: Steel / Plastic

Recessed ceiling loudspeaker, DA 180 mm

Nominal / music load capacity: 40 / 50 W, impedance: 8 Ohm
 Sound pressure level: 1 W / 1 m: 90 dB (at nominal power 98 dB),
 Transmission range (-3 db): 100 - 20,000 Hz,
 Transmission range (-10 db): 60 - 23,000 Hz,
 Model: Plastic front and mounting rings with white perforated plate cover,
 Net weight: 1.0 kg

Mounting in ceilings with 1-20 mm material thickness.
 Connection using 2-core line with connecting terminal.

Moisture impregnated membrane:
 Restricted protection from moisture.

Not suitable for continuous operation in the outdoor area.

Material: Steel / Plastic

Item no.	Color	Price €
3092.07	White	87.20



Item no.	Color	Price €
3094.07	White	199.90





Private house, Norderstedt

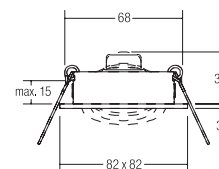
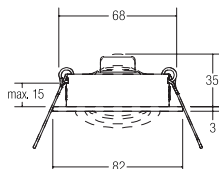

Recessed ceiling loudspeaker, DA 68 mm

Nominal / music load capacity: 3 / 4 W, impedance: 20 Ohm

Up to 5 speakers can be connected in parallel to one channel of a hi-fi amplifier.

Sound pressure level: 1 W / 1 m: 82 dB (at nominal power 87 dB),
 Transmission range (-3 db): 200 - 16,000 Hz,
 Transmission range (-10 db): 150 - 20,000 Hz,
 Net weight: 0.1 kg

Connection using 2-core line with connecting terminal.

Also available with a champagne matte or black shield.

Material: Aluminum / Steel

Recessed ceiling loudspeaker, DA 68 mm

Nominal / music load capacity: 3 / 4 W, impedance: 20 Ohm

Up to 5 speakers can be connected in parallel to one channel of a hi-fi amplifier.

Sound pressure level: 1 W / 1 m: 82 dB (at nominal power 87 dB),
 Transmission range (-3 db): 200 - 16,000 Hz,
 Transmission range (-10 db): 150 - 20,000 Hz,
 Net weight: 0.1 kg

Connection using 2-core line with connecting terminal.

Also available with a champagne matte or black shield.

Material: Aluminum / Steel

Item no.	Color	Price €
43003020	Chromium	90.10
43003070	White	89.00
43003250	Aluminum matte	89.00
43003640	Titanium matte	94.60



Item no.	Color	Price €
43004020	Chromium	92.60
43004070	White	91.50
43004250	Aluminum matte	91.50
43004640	Titanium matte	97.00



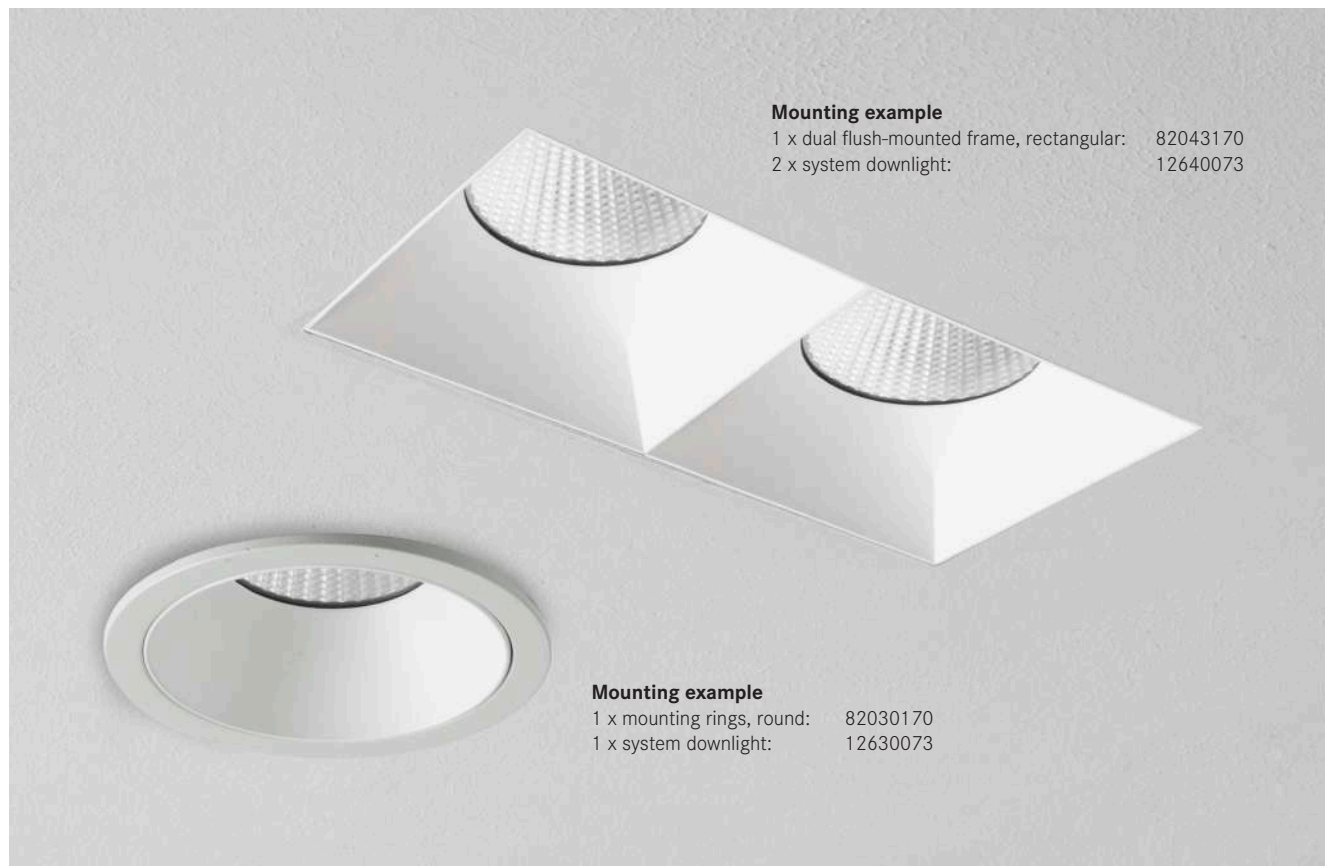

Mounting example

1 x dual flush-mounted frame, rectangular: 82043170
 2 x system downlight: 12640073

Mounting example

1 x mounting rings, round: 82030170
 1 x system downlight: 12630073

COUPLED flush-mounted / recessed frames and rings for COUPLED system luminaires

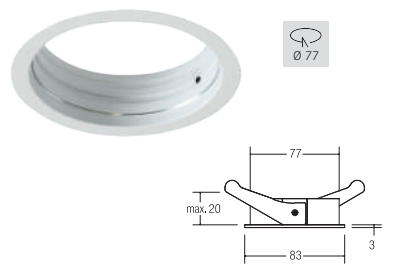

Mounting ring, round

Item no.	Housing color	Diameter	Price in €
82030170	Structural white	83 mm	13.10

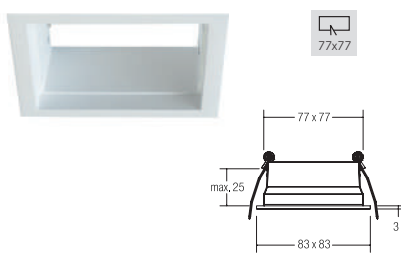

Recessed frame, square

Item no.	Housing color	L x W	Price in €
82040170	Structural white	83 x 83 mm	13.10

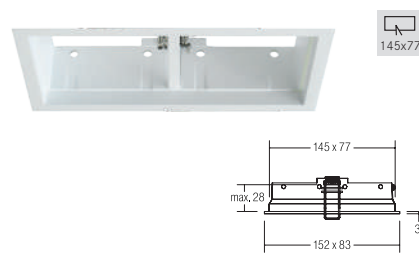

Dual recessed frame, rectangular

Item no.	Housing color	L x W	Price in €
82041170	Structural white	152 x 83 mm	24.20

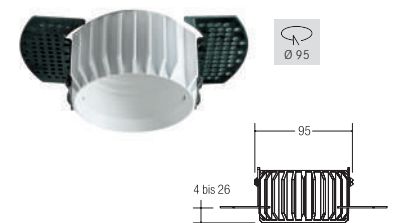

Mounting ring, round, for border-less mounting

Item no.	Housing color	Ceiling thickness	Price in €
82032170	Structural white	4 - 26 mm	23.10

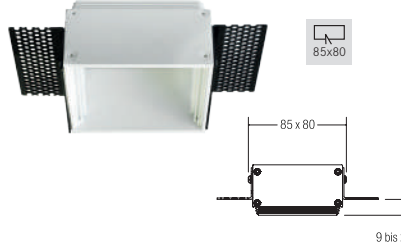

Square flush-mounted frame, for border-less mounting

Item no.	Housing color	Ceiling thickness	Price in €
82042170	Structural white	9 - 24 mm	25.60

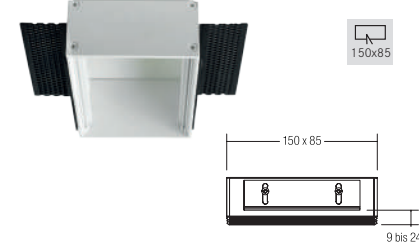

Rectangular dual flush-mounted frame, for border-less mounting

Item no.	Housing color	Ceiling thickness	Price in €
82043170	Structural white	9 - 24 mm	44.00

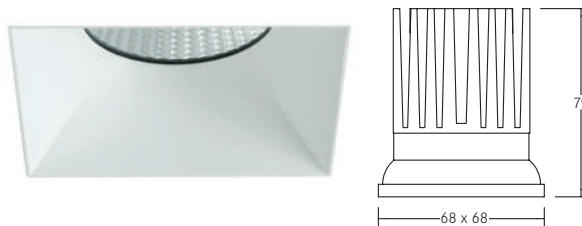
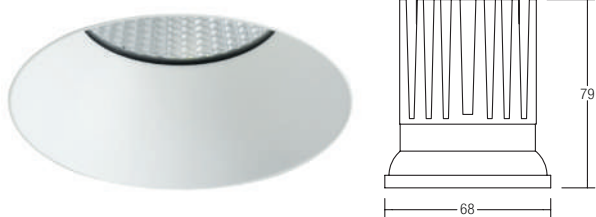

COUPLED LED system downlight, IP44, round

Mounting is possible only without flush-mounted or recessed frame 82030170 or 82032170.

Illuminants: LED, color rendering: CRI > 90, power: 8.9 W, beam angle: 34°, material: Aluminum / Plastic

You will find the corresponding 500-mA converter on page 522.

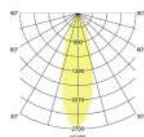

Item no.	Color	Luminous flux	Color temperature	Price €
12630073	White	950 lm	3000 K	64.90

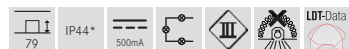

* IP44 when installed in closed ceilings in COUPLED flush-mounted or recessed frame

COUPLED LED system downlight, IP44, square

Mounting is possible only without flush-mounted or recessed frame 82040170, 82041170, 82042170 or 82043170.

Illuminants: LED, color rendering: CRI > 90, power: 8.9 W, beam angle: 34°, material: Aluminum / Plastic

You will find the corresponding 500-mA converter on page 522.

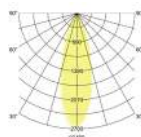

Item no.	Color	Luminous flux	Color temperature	Price €
12640073	White	950 lm	3000 K	64.90

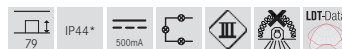

* IP44 when installed in closed ceilings in COUPLED flush-mounted or recessed frame

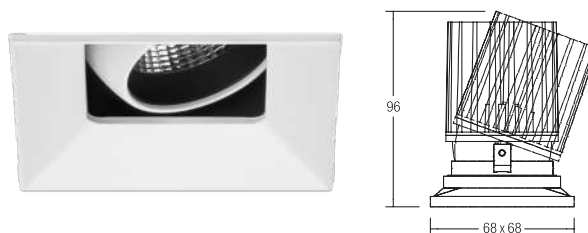
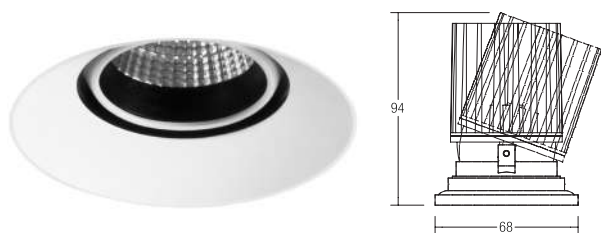

COUPLED LED recessed spotlight system

Mounting is possible only without flush-mounted or recessed frame 82030170 or 82032170.

Illuminants: LED, color rendering: CRI > 90, power: 8.9 W, Beam angle: 34°, material: Aluminum / Plastic

You will find the corresponding 500-mA converter on page 522.

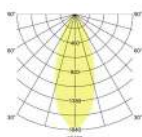

Item no.	Color	Luminous flux	Color temperature	Price €
12632073	White	950 lm	3000 K	79.90



COUPLED LED recessed spotlight system

Mounting is possible only without flush-mounted or recessed frame 82040170, 82041170, 82042170 or 82043170.

Illuminants: LED, color rendering: CRI > 90, power: 8.9 W, Beam angle: 34°, material: Aluminum / Plastic

You will find the corresponding 500-mA converter on page 522.

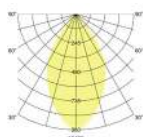

Item no.	Color	Luminous flux	Color temperature	Price €
12642073	White	950 lm	3000 K	79.90



COUPLED LED recessed spotlight system, dim2warm

If the luminaire is dimmed, the color temperature reduces.

Mounting is possible only without flush-mounted or recessed frame 82030170 or 82032170.

Illuminants: LED, color rendering: CRI > 90, power: 9.4 W, beam angle: 34°, material: Aluminum / Plastic

You will find the corresponding 500-mA converter on page 522.

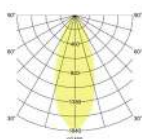

Item no.	Color	Luminous flux	Color temperature	Price €
12634073	White	920 lm	3000 K - 1800 K	94.90



COUPLED LED recessed spotlight system, dim2warm

If the luminaire is dimmed, the color temperature reduces.

Mounting is possible only without flush-mounted or recessed frame 82040170, 82041170, 82042170 or 82043170.

Illuminants: LED, color rendering: CRI > 90, power: 9.4 W, beam angle: 34°, material: Aluminum / Plastic

You will find the corresponding 500-mA converter on page 522.

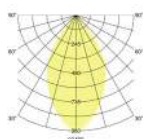

Item no.	Color	Luminous flux	Color temperature	Price €
12644073	White	920 lm	3000 K - 1800 K	94.90



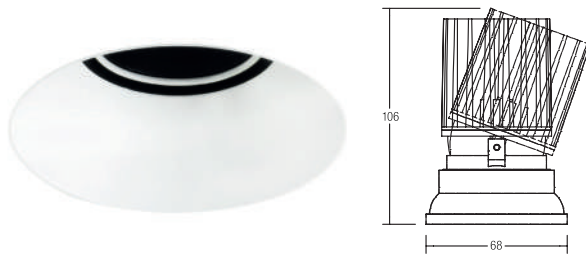

COUPLED LED recessed spotlight system, recessed

Mounting is possible only without flush-mounted or recessed frame 82030170 or 82032170.

Illuminants: LED, color rendering: CRI > 90, power: 8.9 W, beam angle: 34°, material: Aluminum / Plastic

You will find the corresponding 500-mA converter on page 522.

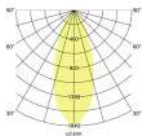

Item no.	Color	Luminous flux	Color temperature	Price €
12631073	White	950 lm	3000 K	79.90

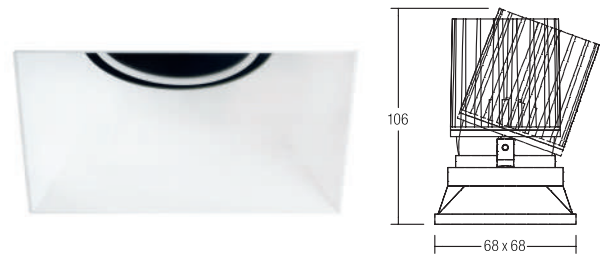

COUPLED LED recessed spotlight system, recessed

Mounting is possible only without flush-mounted or recessed frame 82040170, 82041170, 82042170 or 82043170.

Illuminants: LED, color rendering: CRI > 90, power: 8.9 W, beam angle: 34°, material: Aluminum / Plastic

You will find the corresponding 500-mA converter on page 522.

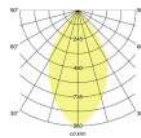

Item no.	Color	Luminous flux	Color temperature	Price €
12641073	White	950 lm	3000 K	79.90



COUPLED LED recessed spotlight system, recessed, dim2warm

If the luminaire is dimmed, the color temperature reduces.

Mounting is possible only without flush-mounted or recessed frame 82030170 or 82032170.

Illuminants: LED, color rendering: CRI > 90, power: 9.4 W, beam angle: 34°, material: Aluminum / Plastic

You will find the corresponding 500-mA converter on page 522.

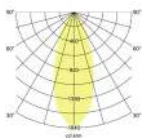

Item no.	Color	Luminous flux	Color temperature	Price €
12633073	White	920 lm	3000 K - 1800 K	94.90



COUPLED LED recessed spotlight system, recessed, dim2warm

If the luminaire is dimmed, the color temperature reduces.

Mounting is possible only without flush-mounted or recessed frame 82040170, 82041170, 82042170 or 82043170.

Illuminants: LED, color rendering: CRI > 90, power: 9.4 W, beam angle: 34°, material: Aluminum / Plastic

You will find the corresponding 500-mA converter on page 522.

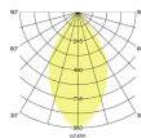

Item no.	Color	Luminous flux	Color temperature	Price €
12643073	White	920 lm	3000 K - 1800 K	94.90





Module system M1. Individuality redefined.

The module system M1 comprises 8 ceiling-mounted recessed and 5 ceiling surface-mounted housings. Choose between a black or a white housing or combine black and white. The luminaire can be assembled in round or square and with one to four lamps. This design freedom allows 156 different housing and color variations for indoor use. The system is compatible with all Brumberg MR16 LED modules in 3 watt, 6 watt and 8 watt.



Module system M1 at a glance.

In 4 steps to the individual luminaire.

1 Housing + module bracket



2 Housing color

For ceiling-flush-mounted LED illuminant.

For recessed LED illuminant.

With glass cover (IP44).

Recessed and surface-mounted versions.

Structural white.

Structural black.

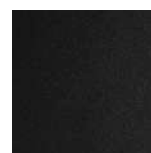
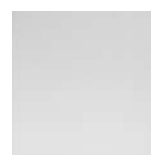



3 LED module

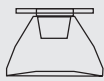

Lens optic 18°, 24°, 38°, 60°.

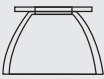

Reflector technology 38°, 60°.

Can be combined with up to 40 MR16 LED modules. Thus maximum flexibility in the choice of technology, color temperature, power and beam angle.



4 Converter + controller



Switchable, DALI, phase section ...

Selection of converters and control units - matched to the corresponding building concept.

For the surface-mounted versions, please note that the maximum LED module assembly (power) is 8 Watt. On/off, phase or DALI.

Beyond 6 W power, the power supply and the control unit must be installed **outside the housing** for reasons of space in the **surface-mounted variants**.



1 Housing + module bracket.

Square housing.

Single-lamp.



Recessed housing flush with the ceiling with rigid IP44 module bracket.

45009... /45010... /45011...

Ceiling cut-outs: 80 mm
Length x width: 93 x 93 mm

Installation depths:

45009: 10 mm + height of LED module
45010: 8 mm + height of LED module
45011: 16 mm + height of LED module



Recessed housing with rigid IP44 module bracket.

45003... /45004... /45005...

Ceiling cut-outs: 92 x 92 mm
Length x width: 105 x 105 mm

Installation depths:

45003: 35 mm + height of LED module
45004: 33 mm + height of LED module
45005: 41 mm + height of LED module



Flush surface-mounted housing with rigid IP44 module bracket.

45110... /45111... /45112...

Length x width: 90 x 90 mm
Height: 115 mm



Recessed housing with rigid IP44 module bracket.

45103... / 45104... / 45105...

Length x width: 90 x 90 mm
Height: 115 mm

Two-lamp.



Recessed housing flush with the ceiling with rigid IP44 module bracket.

45023... /45024... /45025...

Ceiling cut-outs: 160 x 81 mm
Length x width: 175 x 92 mm

Installation depths:

45023: 10 mm + height of LED module
45024: 8 mm + height of LED module
45025: 16 mm + height of LED module

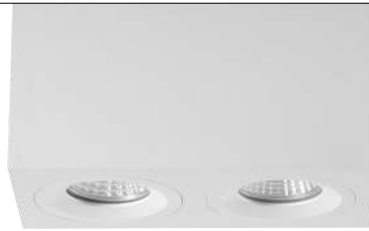

Flush surface-mounted housing with rigid IP44 module bracket.

45123... /45124... /45125...

Length x width: 173 x 90 mm
Height: 95 mm

Three-lamp.



Recessed housing flush with the ceiling with rigid IP44 module bracket.

45026... /45027... /45028...

Ceiling cut-outs: 250 x 81 mm
Length x width: 260 x 92 mm

Installation depths:

45026: 10 mm + height of LED module
45027: 8 mm + height of LED module
45028: 16 mm + height of LED module

Four-lamp.



Recessed housing flush with the ceiling with rigid IP44 module bracket.

45029... /45030... /45031...

Ceiling cut-outs: 165 x 160 mm
Length x width: 175 x 175 mm

Installation depths:

45029: 10 mm + height of LED module
45030: 8 mm + height of LED module
45031: 16 mm + height of LED module

Square or round, flush, recessed or IP44?

Round housing.



Recessed housing flush with the ceiling with rigid IP44 module bracket.

45006... /45007... /45008...

Ceiling cut-outs: 82 mm

Diameter: 92 mm

Installation depths:

45006: 10 mm + height of LED module

45007: 8 mm + height of LED module

45008: 16 mm + height of LED module



Recessed housing with rigid IP44 module bracket.

45000... /45001... /45002...

Ceiling cut-outs: 91 mm

Diameter: 105 mm

Installation depths:

45000: 40 mm + height of LED module

45001: 38 mm + height of LED module

45002: 46 mm + height of LED module



Flush surface-mounted housing with rigid IP44 module bracket.

45106... /45107... /45108...

Diameter: 90 mm

Height: 95 mm



Recessed housing with rigid IP44 module bracket.

45100... /45101... /45102...

Diameter: 90 mm

Height: 115 mm

Single-lamp.



Recessed housing flush with the ceiling with rigid IP44 module bracket.

45020... /45021... /45022...

Ceiling cut-outs: 2 x 82 mm

(at a distance of 82 mm from the center)

Length x width: 175 x 92 mm

Installation depths:

45020: 15 mm + height of LED module

45021: 13 mm + height of LED module

45022: 21 mm + height of LED module

Two-lamp.

Module bracket. Three all-rounders for all housings.



Flush, swiveling (20°)



IP44, rigid



Recessed, swiveling (20°)



Housing color.

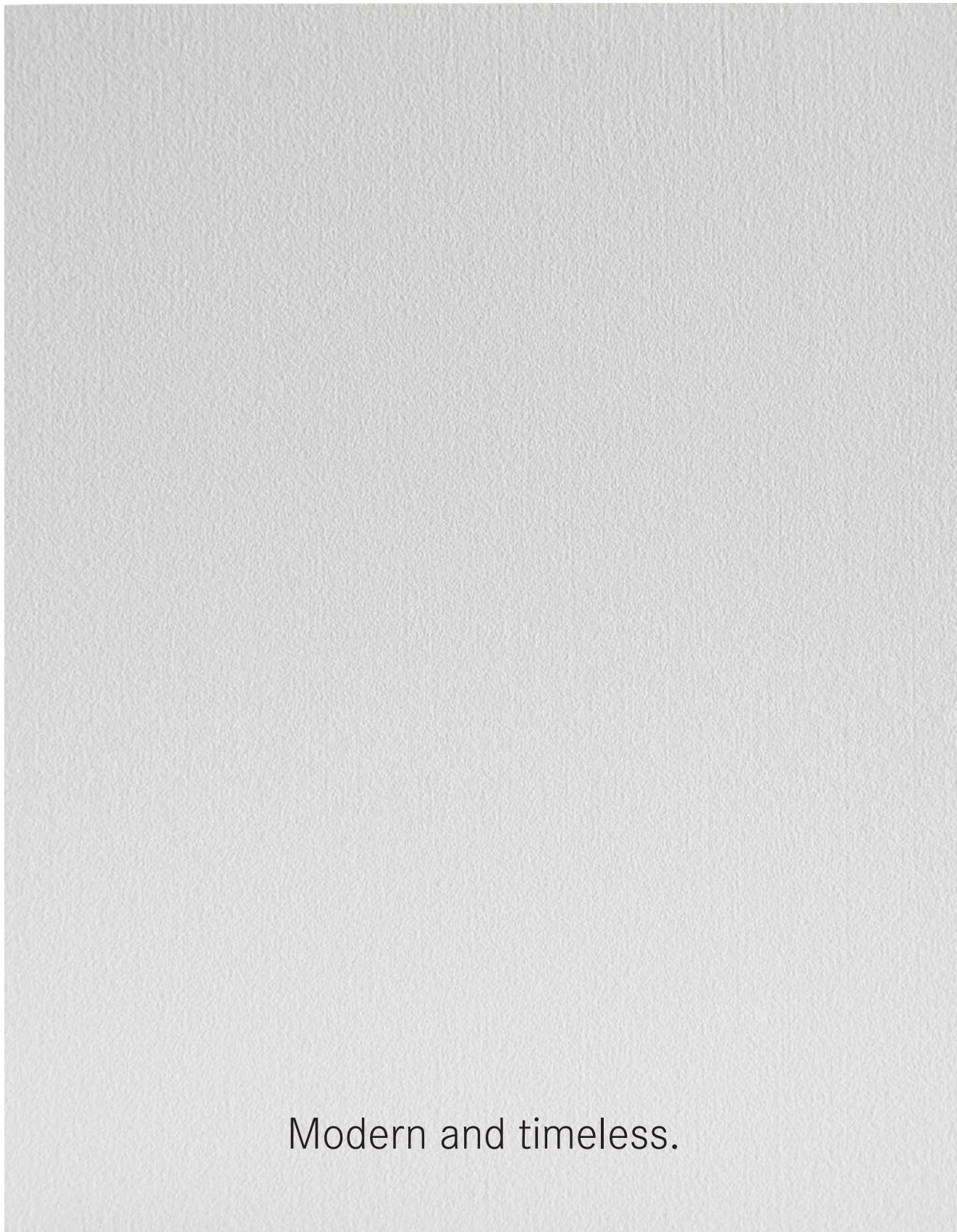







Modern and timeless.

White, black or both?



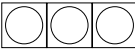



For maximum flexibility.

Recessed housing.

NEW	Housing shape	Housing color (Outer part)	with LED module bracket (inner part)						Price €
			Flush, swiveling, structural white	Flush, swiveling, structural black	Rigid (IP44) structural white	Rigid (IP44) structural black	Recessed, swiveling, structural white	Recessed, swiveling, structural black	
	Flush recessed housing (square)	Structural white	45009170	45009550	45010170	45010550	45011170	45011550	21.50
		Structural black	45009560	45009180	45010560	45010180	45011560	45011180	
	Recessed housing (square)	Structural white	45003170	45003550	45004170	45004550	45005170	45005550	24.00
		Structural black	45003560	45003180	45004560	45004180	45005560	45005180	
	Flush recessed housing, 2-fold (square)	Structural white	45023170	45023550	45024170	45024550	45025170	45025550	43.00
		Structural black	45023560	45023180	45024560	45024180	45025560	45025180	
	Flush recessed housing, 3-fold (square)	Structural white	45026170	45026550	45027170	45027550	45028170	45028550	63.00
		Structural black	45026560	45026180	45027560	45027180	45028560	45028180	
	Flush recessed housing, 4-fold (square)	Structural white	45029170	45029550	45030170	45030550	45031170	45031550	85.00
		Structural black	45029560	45029180	45030560	45030180	45031560	45031180	
	Flush recessed housing (round)	Structural white	45006170	45006550	45007170	45007550	45008170	45008550	21.50
		Structural black	45006560	45006180	45007560	45007180	45008560	45008180	
	Recessed housing (round)	Structural white	45000170	45000550	45001170	45001550	45002170	45002550	24.00
		Structural black	45000560	45000180	45001560	45001180	45002560	45002180	
	Flush recessed housing, 2-fold (oval)	Structural white	45020170	45020550	45021170	45021550	45022170	45022550	43.00
		Structural black	45020560	45020180	45021560	45021180	45022560	45022180	



Surface-mounted housing.

NEW	Housing shape	Housing color (Outer part)	with LED module bracket (inner part)						Price €
			Flush, swiveling, structural white	Flush, swiveling, structural black	Rigid (IP44) structural white	Rigid (IP44) structural black	Recessed, swiveling, structural white	Recessed, swiveling, structural black	
	Surface-mounted housing (square)	Structural white	45110170	45110550	45111170	45111550	45112170	45112550	60.00
		Structural black	45110560	45110180	45111560	45111180	45112560	45112180	
	Recessed surface-mounted housing (square)	Structural white	45103170	45103550	45104170	45104550	45105170	45105550	66.00
		Structural black	45103560	45103180	45104560	45104180	45105560	45105180	
	Flush surface-mounted housing, 2-fold (square)	Structural white	45123170	45123550	45124170	45124550	45125170	45125550	112.00
		Structural black	45123560	45123180	45124560	45124180	45125560	45125180	
	Flush surface-mounted housing (round)	Structural white	45106170	45106550	45107170	45107550	45108170	45108550	60.00
		Structural black	45106560	45106180	45107560	45107180	45108560	45108180	
	Recessed surface-mounted housing (round)	Structural white	45100170	45100550	45101170	45101550	45102170	45102550	66.00
		Structural black	45100560	45100180	45101560	45101180	45102560	45102180	

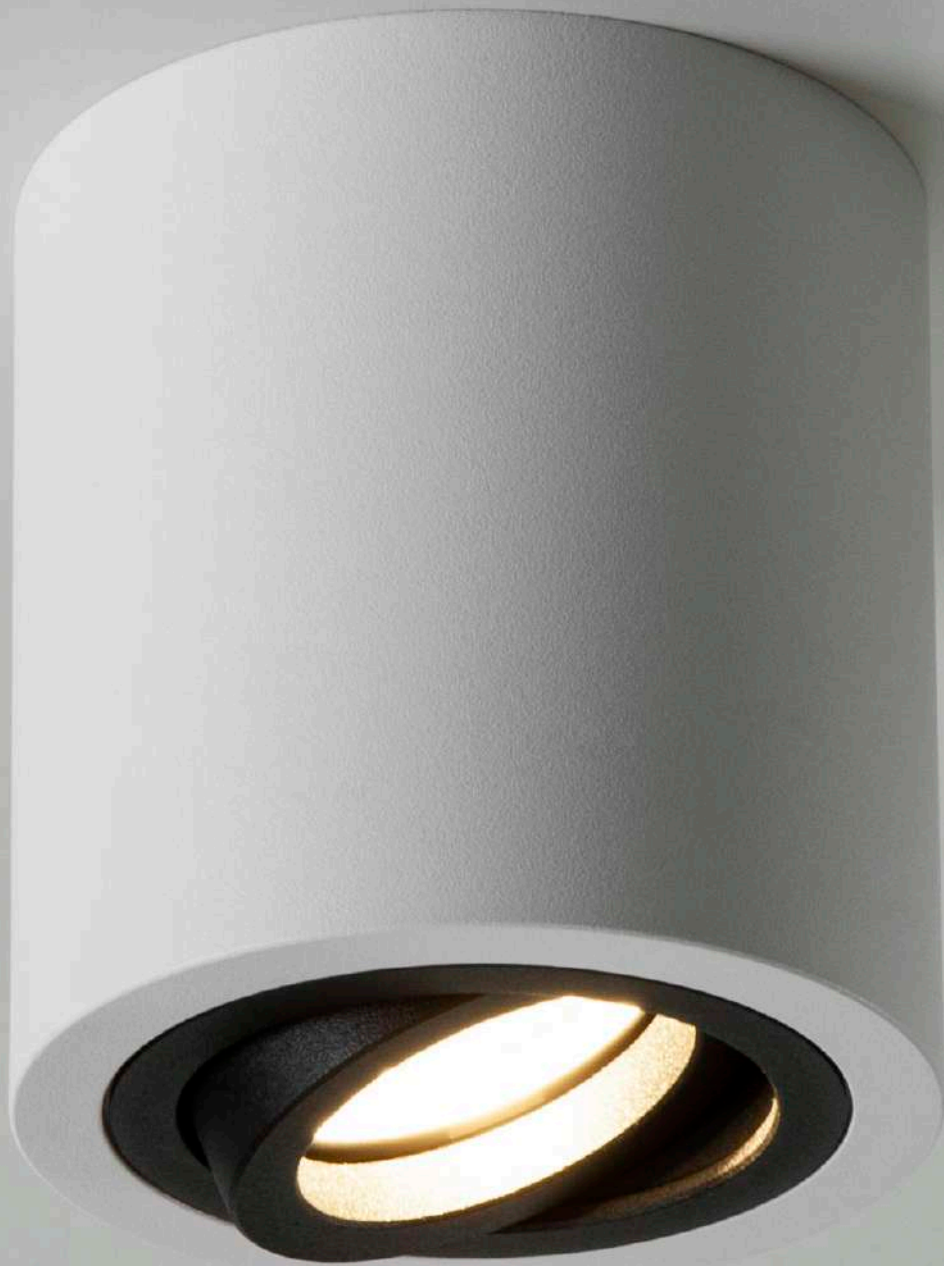

Configuration example.

Light.

Customized design.

For a simplified overview, you will find a configuration on page 594.

For the surface-mounted versions, please note that the maximum LED module assembly (power) is 8 Watt. On/off, phase or DALI.

Beyond 6 W power, the power supply and the control unit must be installed **outside the housing** for reasons of space in the **surface-mounted variants**.

3 LED module. What is your light type?

Can be combined with up to 40 MR16 LED modules.
Thus maximum flexibility in the choice of technology,
color temperature, power and beam angle.

You can find more information in the LED modules section.



**DISC LED insert, MR16,
6 W, with lens optics, 350 mA**

Illuminants: LED, model: Plug&Play, color rendering: CRI > 80,
power: 6 W, beam angle: 18°, 24°, 38°, or 60°,
material: Aluminum / Plastic



MR16 LED reflector insert, 6 W, 350 mA

Illuminants: LED, model: Plug&Play, color rendering: CRI > 80,
power: 6 W, beam angle: 38° or 60°, material: Aluminum / Glass



**Tunable
WHITE**

**MR16 LED reflector insert,
8 W, TunableWhite, 24 V DC**

Connection cable: 3-core, control unit: negative (common anode) (C. A.)

Illuminants: LED, power: 8 W, beam angle: 60°,
Material: Aluminum / Glass

When using this 24-V insert in surface-mounted housings, the power
supply (and the controller, if applicable) must be accommodated **out-**
side the housing on the site.



dim2warm

**MR16 LED reflector insert, 6 W,
dim2warm, 350 mA**

If the LED module is dimmed, the color temperature reduces.

Illuminants: LED, model: Plug&Play, color rendering: CRI > 80,
power: 6 W, beam angle: 38° or 60°, light color: 3000 K - 1800 K,
material: Aluminum / Glass

4 Controller. Digital or analog?

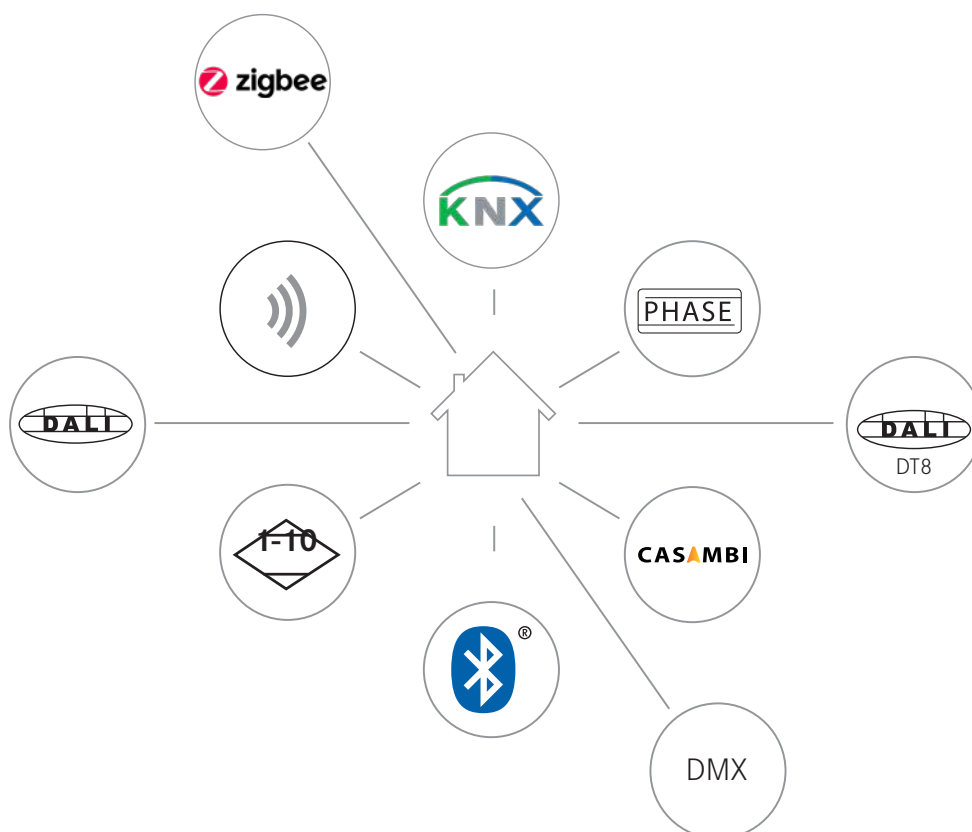

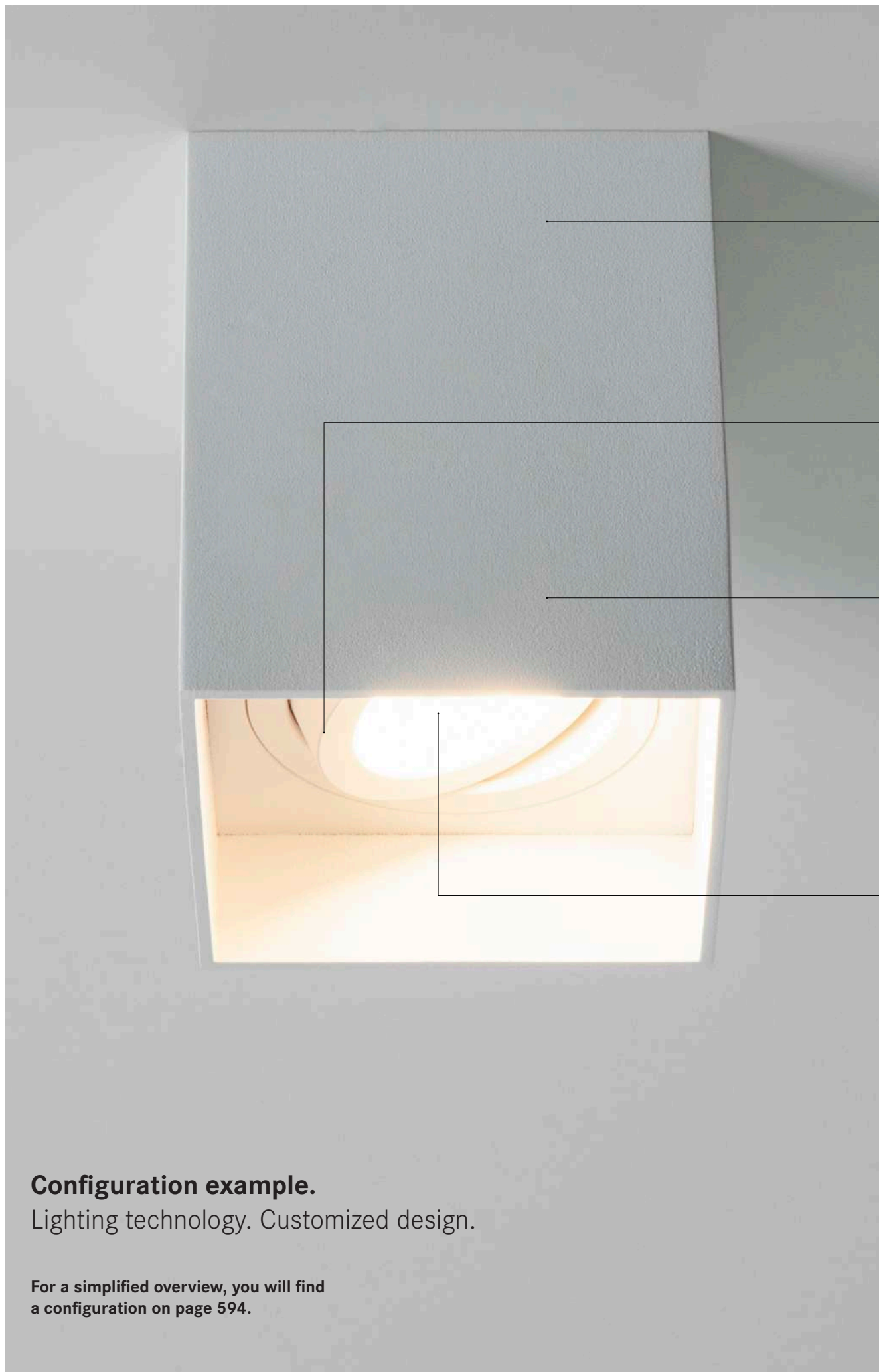

Configuration example.

Lighting technology. Customized design.

**For a simplified overview, you will find
a configuration on page 594.**



1. Step. Housing + module bracket.

Single-lamp, recessed surface-mount housing with swiveling, flush-mounted module bracket.



Item number 1
45103170



2. Step. Housing color.

Structural white.



3. Step. LED module.

Choose one of 40 LED modules between 3 Watt and 8 Watt.

Item number 2
12920243



4. Step. Converter + controller.

Select the desired converter and, if necessary, the control unit.

For the surface-mounted versions, please note that the maximum LED module assembly (power) is 8 Watt. On/off, phase or DALI.

Beyond 6 W power, the power supply and the control unit must be installed **outside the housing** for reasons of space in the **surface-mounted variants**.

Item number 3
17652000

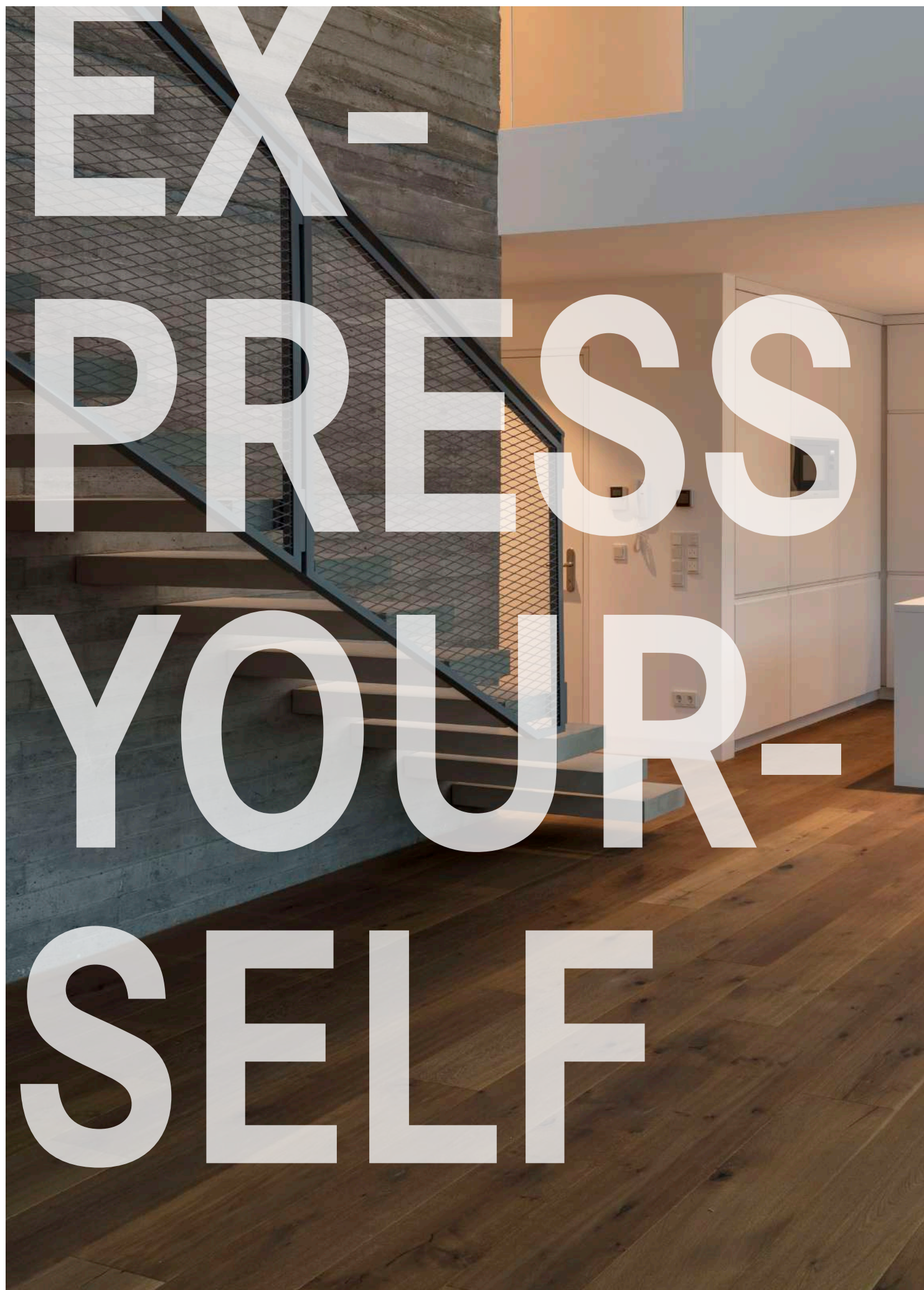



Private residence, Berlin

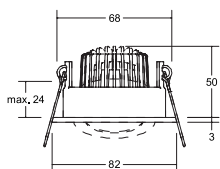

LED recessed spotlight, IP65

NEW

Illuminants: LED, model: Plug&Play, color rendering: CRI > 80, power: 6 W, beam angle: 38°, material: Aluminum / Steel / Silicon rubber / Plastic

You will find the corresponding 350-mA converters from page 516 onwards.

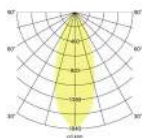

Item no.	Color	Luminous flux	Color temperature	Price €
12353023	Chromium	650 lm	3000 K	71.30
12353073	White	650 lm	3000 K	68.00
12353083	NEW Black	650 lm	3000 K	68.00
12353253	Aluminum matte	650 lm	3000 K	71.00
12353643	Titanium matte	650 lm	3000 K	76.60



LED recessed spotlight set IP65, switchable

NEW

Set including converter for 230 V mains voltage, switchable, dimensions of converter: L 100 x W 38 x H 22 mm

Illuminants: LED, color rendering: CRI > 80, power: 6 W, beam angle: 38°, material: Aluminum / Steel / Silicon rubber / Plastic

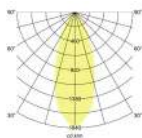

Item no.	Color	Luminous flux	Color temperature	Price €
33353023	Chromium	650 lm	3000 K	94.80
33353073	White	650 lm	3000 K	91.50
33353083	NEW Black	650 lm	3000 K	91.50
33353253	Aluminum matte	650 lm	3000 K	94.50
33353643	Titanium matte	650 lm	3000 K	100.10



LED recessed spotlight set, IP65, dimmable phase section

NEW

Set including converter for 230 V mains voltage, dimmable phase section, dimensions of converter: L 110 x W 50 x H 19 mm

Illuminants: LED, color rendering: CRI > 80, power: 6 W, beam angle: 38°, material: Aluminum / Steel / Silicon rubber / Plastic

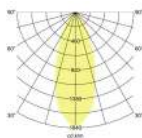

Item no.	Color	Luminous flux	Color temperature	Price €
39353023	Chromium	650 lm	3000 K	98.70
39353073	White	650 lm	3000 K	95.40
39353083	NEW Black	650 lm	3000 K	95.40
39353253	Aluminum matte	650 lm	3000 K	98.40
39353643	Titanium matte	650 lm	3000 K	104.00



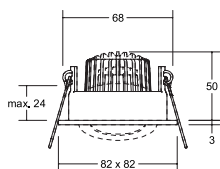

LED recessed spotlight, IP65

NEW

Illuminants: LED, model: Plug&Play, color rendering: CRI > 80, power: 6 W, beam angle: 38°, material: Aluminum / Steel / Silicon rubber / Plastic

You will find the corresponding 350-mA converters from page 516 onwards.

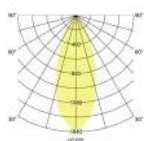

Item no.	Color	Luminous flux	Color temperature	Price €
12355023	Chromium	650 lm	3000 K	73.60
12355073	White	650 lm	3000 K	70.30
12355083	NEW Black	650 lm	3000 K	70.30
12355253	Aluminum matte	650 lm	3000 K	73.40
12355643	Titanium matte	650 lm	3000 K	78.90



LED recessed spotlight set IP65, switchable

NEW

Set including converter for 230 V mains voltage, switchable, dimensions of converter: L 100 x W 38 x H 22 mm

Illuminants: LED, color rendering: CRI > 80, power: 6 W, beam angle: 38°, material: Aluminum / Steel / Silicon rubber / Plastic

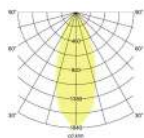

Item no.	Color	Luminous flux	Color temperature	Price €
33355023	Chromium	650 lm	3000 K	97.10
33355073	White	650 lm	3000 K	93.80
33355083	NEW Black	650 lm	3000 K	93.80
33355253	Aluminum matte	650 lm	3000 K	96.90
33355643	Titanium matte	650 lm	3000 K	102.40



LED recessed spotlight set, IP65, dimmable phase section

NEW

Set including converter for 230 V mains voltage, phase section, dimensions of converter: L 110 x W 50 x H 19 mm

Illuminants: LED, color rendering: CRI > 80, power: 6 W, beam angle: 38°, material: Aluminum / Steel / Silicon rubber / Plastic

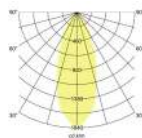

Item no.	Color	Luminous flux	Color temperature	Price €
39355023	Chromium	650 lm	3000 K	101.00
39355073	White	650 lm	3000 K	97.70
39355083	NEW Black	650 lm	3000 K	97.70
39355253	Aluminum matte	650 lm	3000 K	100.80
39355643	Titanium matte	650 lm	3000 K	106.30



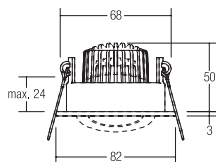

dim2warm

LED recessed spotlight, IP65, dim2warm

If the luminaire is dimmed, the color temperature reduces.

Illuminants: LED, model: Plug&Play, color rendering: CRI > 90, power: 6 W, beam angle: 38°, material: Aluminum / Steel / Silicon rubber / Plastic

You will find the corresponding 350-mA converters from page 516 onwards.

Item no.	Color	Luminous flux	Color temperature	Price €
12443023	Chromium	460 lm	3000 K - 1800 K	82.30
12443073	White	460 lm	3000 K - 1800 K	81.00
12443253	Aluminum matte	460 lm	3000 K - 1800 K	84.10
12443643	Titanium matte	460 lm	3000 K - 1800 K	86.60

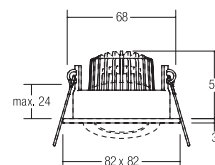

dim2warm

LED recessed spotlight, IP65, dim2warm

If the luminaire is dimmed, the color temperature reduces.

Illuminants: LED, model: Plug&Play, color rendering: CRI > 90, power: 6 W, beam angle: 38°, material: Aluminum / Steel / Silicon rubber / Plastic

You will find the corresponding 350-mA converters from page 516 onwards.

Item no.	Color	Luminous flux	Color temperature	Price €
12445023	Chromium	460 lm	3000 K - 1800 K	84.50
12445073	White	460 lm	3000 K - 1800 K	83.40
12445253	Aluminum matte	460 lm	3000 K - 1800 K	86.50
12445643	Titanium matte	460 lm	3000 K - 1800 K	88.90

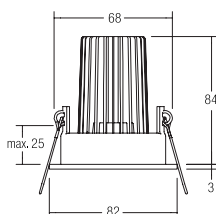

dim2warm

LED recessed spotlight, IP65, dim2warm

If the luminaire is dimmed, the color temperature reduces.

Illuminants: LED, model: Plug&Play, color rendering: CRI > 90, power: 12 W, beam angle: 38°, material: Aluminum / Steel / Silicon rubber / Plastic

You will find the corresponding 350-mA converters from page 516 onwards.

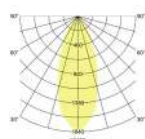

Item no.	Color	Luminous flux	Color temperature	Price €
12444073	White	900 lm	3000 K - 1800 K	95.60
12444253	Aluminum matte	900 lm	3000 K - 1800 K	98.30

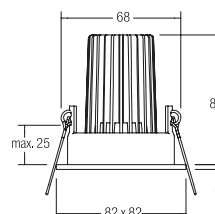

dim2warm

LED recessed spotlight, IP65, dim2warm

If the luminaire is dimmed, the color temperature reduces.

Illuminants: LED, model: Plug&Play, color rendering: CRI > 90, power: 12 W, beam angle: 38°, material: Aluminum / Steel / Silicon rubber / Plastic

You will find the corresponding 350-mA converters from page 516 onwards.

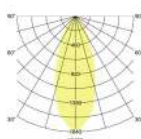

Item no.	Color	Luminous flux	Color temperature	Price €
12446073	White	900 lm	3000 K - 1800 K	97.70
12446253	Aluminum matte	900 lm	3000 K - 1800 K	100.40



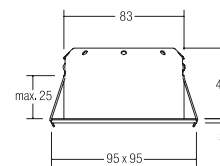
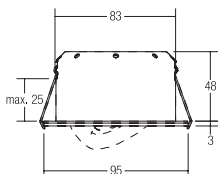

INDIWO83 LED recessed spotlight, IP44, rotatable and swiveling

Recessed spotlights are suitable for direct mounting on normally flammable building materials. Thermal insulation is permissible.

Illuminants: LED, model: Plug&Play, color rendering: CRI > 85, power: 6 W, beam angle: 36°, material: Aluminum / Steel / Plastic

You will find the corresponding 350-mA converters from page 516 onwards.

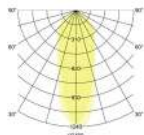

Item no.	Color	Luminous flux	Color temperature	Price €
12277153	Nickel matte	510 lm	3000 K	72.60
12277173	Structural white	510 lm	3000 K	65.80



* IP44 when installed in closed ceilings

INDIWO83 LED recessed spotlight, IP44, rotatable and swiveling

Recessed spotlights are suitable for direct mounting on normally flammable building materials. Thermal insulation is permissible.

Illuminants: LED, model: Plug&Play, color rendering: CRI > 85, power: 6 W, beam angle: 36°, material: Aluminum / Steel / Plastic

You will find the corresponding 350-mA converters from page 516 onwards.

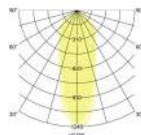

Item no.	Color	Luminous flux	Color temperature	Price €
12287153	Nickel matte	510 lm	3000 K	74.70
12287173	Structural white	510 lm	3000 K	68.10



* IP44 when installed in closed ceilings

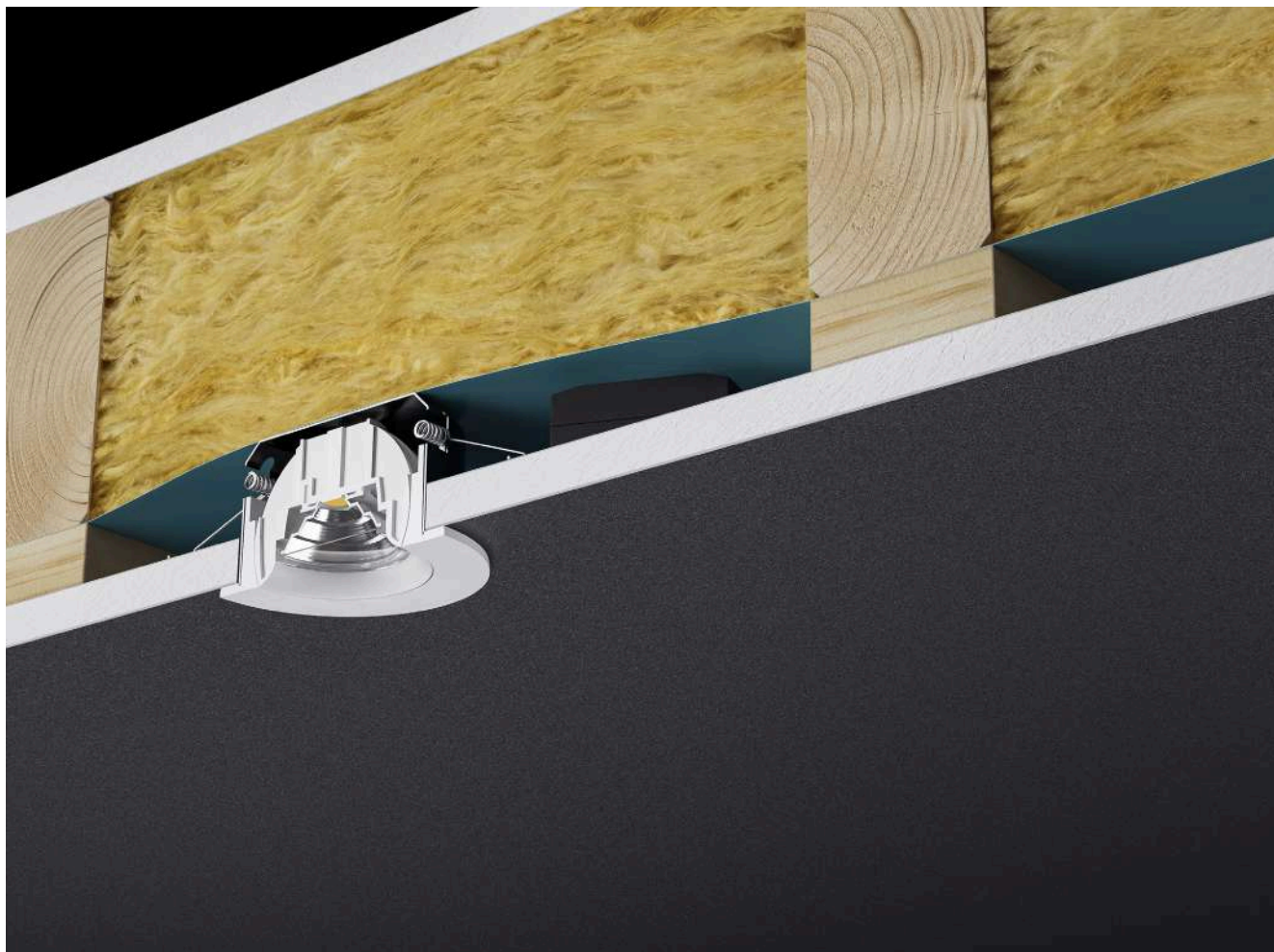

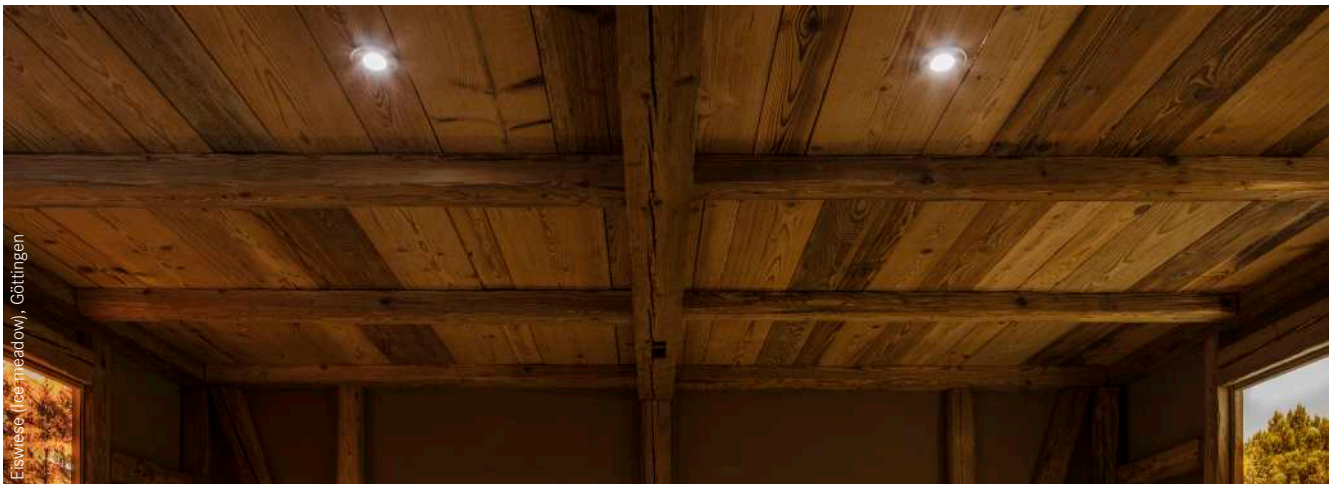

STEAM.

Light for the steam and dry sauna.

Steam is a particularly corrosion and temperature resistant recessed downlight for screw (IP65) or spring mounting (IP54). These lights are ideal for saunas and steam cabins as well as coastal and offshore areas. They are available in 2 shapes, 2 designs, 2 surfaces and are compatible with 40 different LED modules with the corresponding control units.

To the product
video.



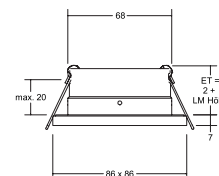
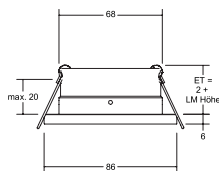

STEAM recessed downlight, V4A, IP65

NEW

All Brumberg MR16 LED modules can be used for the STEAM recessed unit. The installation depth of the luminaire depends on the respective LED module used (here: 2 mm excluding the height of the LED module).

Illuminants: For LED, power: maximum 14 W, material: Stainless steel V4A / Aluminum / Glass / Silicon rubber, delivery: including LED module support on the rear side

You will find corresponding LED modules from page 504 onwards and corresponding converters from 516 onwards.

The LED module is not included in the scope of delivery of the recessed unit.

Caution: Pay attention to the height of the illuminant!

Item no.	Color	Price €
37005070	NEW White	68.80
37005420	NEW Stainless steel	71.40



* IP65 when installed in closed ceilings (in case of screw mounting)

STEAM recessed downlight, V4A, IP54

NEW

All Brumberg MR16 LED modules can be used for the STEAM recessed unit. The installation depth of the luminaire depends on the respective LED module used (here: 2 mm excluding the height of the LED module).

Illuminants: For LED, power: maximum 14 W, material: Stainless steel V4A / Aluminum / Glass / Silicon rubber, delivery: including LED module support on the rear side

You will find corresponding LED modules from page 504 onwards and corresponding converters from 516 onwards.

The LED module is not included in the scope of delivery of the recessed unit.

Caution: Pay attention to the height of the illuminant!

Item no.	Color	Price €
37006070	NEW White	73.50
37006420	NEW Stainless steel	77.40



* IP54 when installed in closed ceilings (spring mounting)

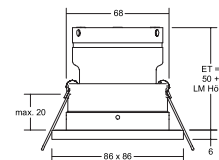
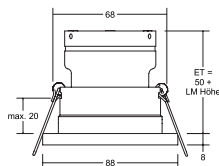

STEAM recessed downlight, V4A, IP65

NEW

All Brumberg MR16 LED modules can be used for the STEAM recessed unit. The installation depth of the luminaire depends on the respective LED module used (here: 50 mm excluding the height of the LED module).

Illuminants: For LED, power: maximum 14 W, material: Stainless steel V4A / Aluminum / Glass / Silicon rubber, delivery: including LED module support on the rear side

You will find corresponding LED modules from page 504 onwards and corresponding converters from 516 onwards.

The LED module is not included in the scope of delivery of the recessed unit.

Caution: Pay attention to the height of the illuminant!

Item no.	Color	Price €
37015070	NEW White	71.20
37015420	NEW Stainless steel	73.30



* IP65 when installed in closed ceilings (in case of screw mounting) High version with air buffer for e.g. hotter sauna areas.

STEAM recessed downlight, V4A, IP54

NEW

All Brumberg MR16 LED modules can be used for the STEAM recessed unit. The installation depth of the luminaire depends on the respective LED module used (here: 50 mm excluding the height of the LED module).

Illuminants: For LED, power: maximum 14 W, material: Stainless steel V4A / Aluminum / Glass / Silicon rubber, delivery: including LED module support on the rear side

You will find corresponding LED modules from page 504 onwards and corresponding converters from 516 onwards.

The LED module is not included in the scope of delivery of the recessed unit.

Caution: Pay attention to the height of the illuminant!

Item no.	Color	Price €
37016070	NEW White	75.50
37016420	NEW Stainless steel	79.40



* IP54 when installed in closed ceilings (in case of spring mounting) High version with air buffer for e.g. hotter sauna areas.



COVER-UP.

IP44 - the spot for every illuminant.

Cover-up has the classic recessed dimension of 68 millimeters. These luminaires are therefore practically suitable for every field of application. Thanks to the quick and uncomplicated installation with the clip-in system for 50-millimeter LED modules, it is very easy to install. The show-stopper: With protection class IP44, the Cover-Up can also be installed in wet and spa areas.

To the product
video.



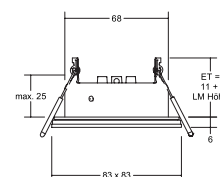
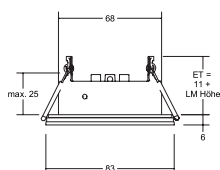

Cover-up recessed downlight, IP44

NEW

All Brumberg MR16 LED modules can be used for the COVER-UP recessed unit. The installation depth of the luminaire depends on the respective LED module used (here: 11 mm excluding the height of the LED module).

Illuminants: For LED, power: maximum 14 W, material: Aluminum / Steel / Glass, delivery: including the LED module support on the rear side and the clear decorative glass

You will find corresponding LED modules from page 504 onwards and corresponding converters from 516 onwards.

The LED module is not included in the scope of delivery of the recessed unit.

Caution: Pay attention to the height of the illuminant!



Item no.	Color	Price €
45320070	NEW White with clear decorative glass	45.90
45320080	NEW Black with clear decorative glass	45.90



* IP44 when installed in closed ceilings

Cover-up recessed downlight, IP44

NEW

All Brumberg MR16 LED modules can be used for the COVER-UP recessed unit. The installation depth of the luminaire depends on the respective LED module used (here: 11 mm excluding the height of the LED module).

Illuminants: For LED, power: maximum 14 W, material: Aluminum / Steel / Glass, delivery: including the LED module support on the rear side and the clear decorative glass

You will find corresponding LED modules from page 504 onwards and corresponding converters from 516 onwards.

The LED module is not included in the scope of delivery of the recessed unit.

Caution: Pay attention to the height of the illuminant!



Item no.	Color	Price €
45321070	NEW White with clear decorative glass	48.10
45321080	NEW Black with clear decorative glass	48.10



* IP44 when installed in closed ceilings



ALTERO recessed downlight, IP44

NEW

Illuminants: LED, color rendering: CRI > 80, power: 9.2 W, Beam angle: 33°, material: Aluminum / Glass

You will find the corresponding 500-mA converter on page 522.

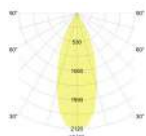

Item no.	Color	Luminous flux	Color temperature	Price €
12035173	Structural white	820 lm	3000 K	105.50
12035174	Structural white	840 lm	4000 K	105.50
12035183	NEW Structural black	820 lm	3000 K	105.50
12035184	NEW Structural black	840 lm	4000 K	105.50
12035403	Structural white / chromium	820 lm	3000 K	105.50
12035404	Structural white / chromium	840 lm	4000 K	105.50
12035553	Structural white / structural black	820 lm	3000 K	105.50
12035554	Structural white / structural black	840 lm	4000 K	105.50
12035753	Structural white / structural gold	820 lm	3000 K	105.50
12035754	Structural white / structural gold	840 lm	4000 K	105.50
12035853	Structural black / structural gold	820 lm	3000 K	105.50
12035854	Structural black / structural gold	840 lm	4000 K	105.50



* IP44 when installed in closed ceilings, complete shield can be replaced on the site via bayonet.

ALTERO is also available in 2700 K on request.

ALTERO recessed downlight, IP44

NEW

Illuminants: LED, color rendering: CRI > 80, power: 9.2 W, Beam angle: 33°, material: Aluminum / Glass

You will find the corresponding 500-mA converter on page 522.

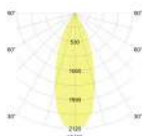

Item no.	Color	Luminous flux	Color temperature	Price €
12036173	Structural white	820 lm	3000 K	105.50
12036174	Structural white	840 lm	4000 K	105.50
12036183	NEW Structural black	820 lm	3000 K	105.50
12036184	NEW Structural black	840 lm	4000 K	105.50
12036403	Structural white / chromium	820 lm	3000 K	105.50
12036404	Structural white / chromium	840 lm	4000 K	105.50
12036553	Structural white / structural black	820 lm	3000 K	105.50
12036554	Structural white / structural black	840 lm	4000 K	105.50
12036753	Structural white / structural gold	820 lm	3000 K	105.50
12036754	Structural white / structural gold	840 lm	4000 K	105.50
12036853	Structural black / structural gold	820 lm	3000 K	105.50
12036854	Structural black / structural gold	840 lm	4000 K	105.50



* IP44 when installed in closed ceilings, complete shield can be replaced on the site via bayonet.

ALTERO is also available in 2700 K on request.

ALTERO.

Modular product series with different colored luminaire covers. For flexible lighting solutions with changing room concepts - from neutral to accentuated.

Colors and shapes.

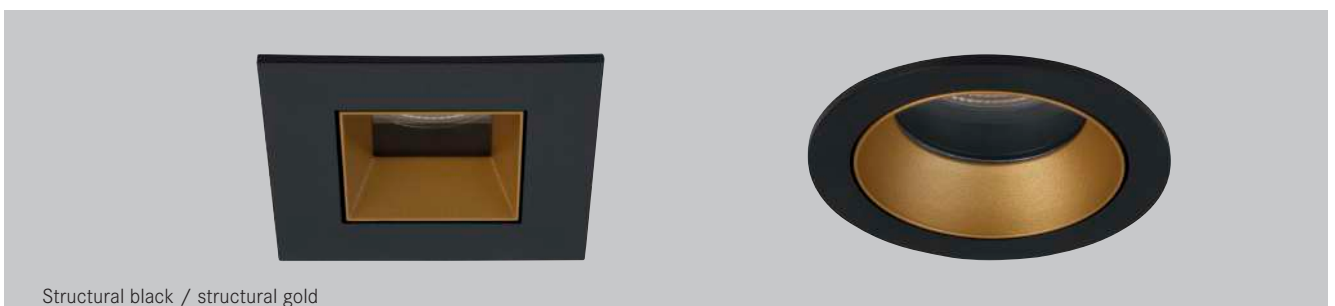
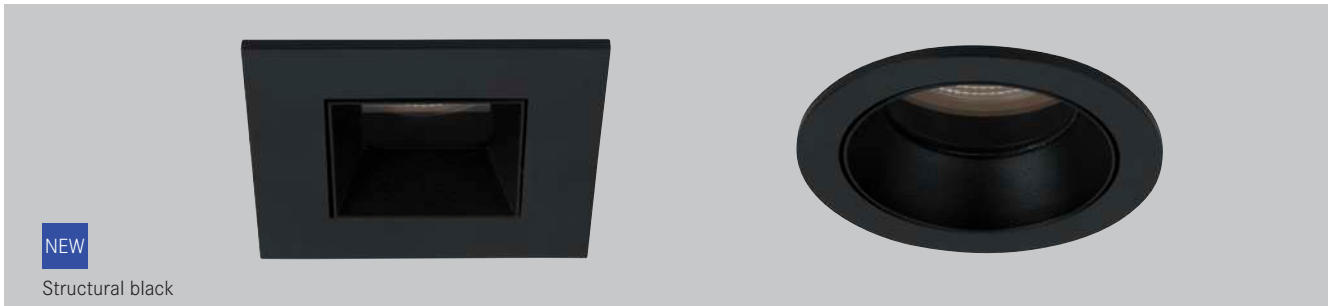
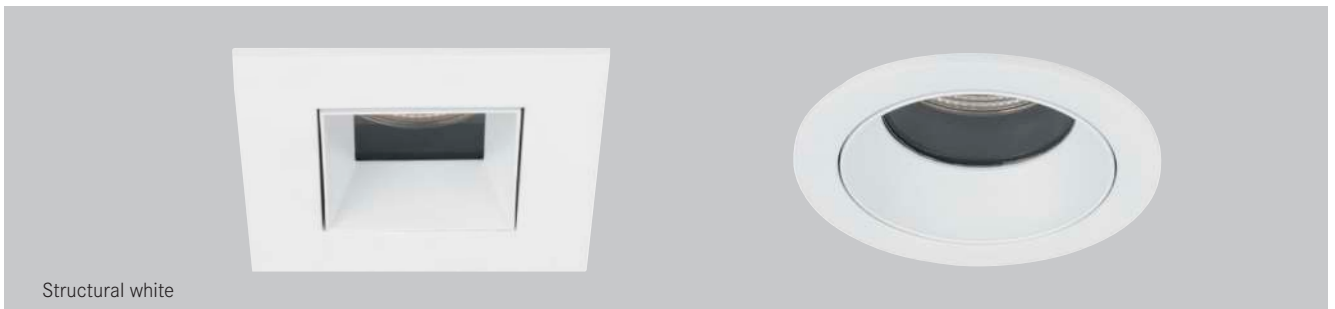



LED recessed downlight, IP54

Illuminants: LED, model: Plug&Play, color rendering: CRI > 80, power: 10 W, beam angle: 90°, material: Aluminum / Plastic

You will find the corresponding 350-mA converters from page 516 onwards.

Item no.	Color	Luminous flux	Color temperature	Price €
12366073	White	750 lm	3000 K	84.60

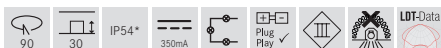

* IP54 when installed in closed ceilings



Recessed downlight, IP65, GX5.3

Illuminants: For LED retrofit lamp, model: GX5.3, power: maximum 35 W, material: Stainless steel / Glass

Item no.	Color	Price €
2264.22	Stainless steel	32.50



* IP65 when installed in closed ceilings



LED recessed downlight, IP54

Illuminants: LED, color rendering: CRI > 80, power: 9.2 W, beam angle: 38°, material: Aluminum / Glass

You will find the corresponding 500-mA converter on page 522.

Item no.	Color	Luminous flux	Color temperature	Price €
12270173	Structural white	820 lm	3000 K	97.80
12270174	Structural white	840 lm	4000 K	97.80
12270183	Structural black	820 lm	3000 K	97.80
12270184	Structural black	840 lm	4000 K	97.80



* IP54 when installed in closed ceilings

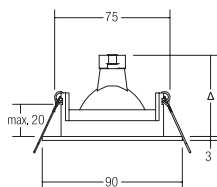

Recessed downlight, IP65, GX5.3

Illuminants: For LED retrofit lamp, model: GX5.3, power: maximum 35 W, material: Aluminum / Glass

Item no.	Color	Price €
20368070	White	35.70
20368150	Nickel matte	39.30
20368680	Silver	35.70

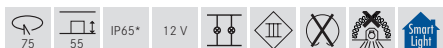

* IP65 when installed in closed ceilings

LED recessed downlight, IP65

Illuminants: LED, model: Plug&Play, color rendering: CRI > 80, power: 6 W, beam angle: 38°, material: Aluminum / Glass

You will find the corresponding 350-mA converters from page 516 onwards.

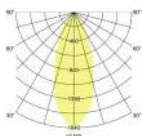

Item no.	Color	Luminous flux	Color temperature	Price €
13368073	White	680 lm	3000 K	87.50
13368153	Nickel matte	680 lm	3000 K	91.10
13368683	Silver	680 lm	3000 K	87.50



* IP65 when installed in closed ceilings



Eiswiese (Ice meadow), Göttingen

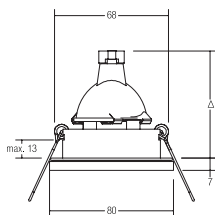

Recessed downlight, IP65, GX5.3

Illuminants: For LED retrofit lamp, model: GX5.3, power: maximum 50 W, material: Cast / Glass

Item no.	Color	Price €
2062.02	Chromium	32.50
2062.07	White	29.30
2062.25	Nickel matte	31.10



* IP65 when installed in closed ceilings

Recessed downlight, IP65, GU10

Including bracket with GU10 holder for standard-compliant strain relief.

Illuminants: For LED retrofit lamp, model: GU10, power: maximum 50 W, material: Cast / Glass

Item no.	Color	Price €
36149020	Chromium	43.50
36149070	White	40.30
36149250	Nickel matte	42.10

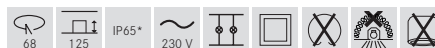

* IP65 when installed in closed ceilings

LED recessed downlight set, IP65, switchable

Set including converter for 230 V mains voltage, switchable, dimensions of converter: L 68 x W 35 x H 21 mm

Illuminants: LED, color rendering: CRI > 80, power: 6 W, beam angle: 38°, material: Cast / Aluminum / Glass / Plastic

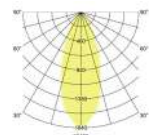

Item no.	Color	Luminous flux	Color temperature	Price €
38149023	Chromium	540 lm	3000 K	107.80
38149073	White	540 lm	3000 K	104.60
38149253	Nickel matte	540 lm	3000 K	106.40

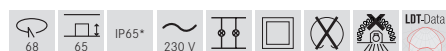

* IP65 when installed in closed ceilings

LED recessed downlight set, IP65, dimmable phase section

NEW

Set including converter for 230 V mains voltage, dimmable phase section, dimensions of converter: L 110 x W 50 x H 19 mm

Illuminants: LED, color rendering: CRI > 80, power: 6W, beam angle: 38°, material: Cast / Aluminum / Glass / Plastic

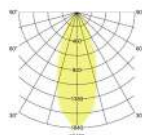

Item no.	Color	Luminous flux	Color temperature	Price €
39149023	NEW Chromium	540 lm	3000 K	111.70
39149073	NEW White	540 lm	3000 K	108.50
39149253	NEW Nickel matte	540 lm	3000 K	110.30

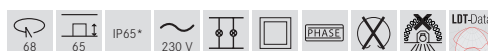

* IP65 when installed in closed ceilings

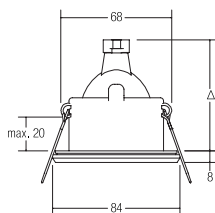

Recessed downlight, V4A, IP65, GX5.3

Illuminants: For LED retrofit lamp, model: GX5.3, power: maximum 50 W, material: Stainless steel V4A / Glass

Recessed downlight, V4A, IP65, GU10

Including bracket with GU10 holder for standard-compliant strain relief.

Illuminants: For LED retrofit lamp, model: GU10, power: maximum 50 W, material: Stainless steel V4A / Glass

Item no.	Color	Price €
2339.42	Stainless steel	68.10



* IP65 when installed in closed ceilings

Item no.	Color	Price €
36306420	Stainless steel	79.10

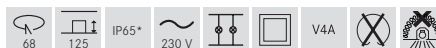

* IP65 when installed in closed ceilings

LED recessed downlight set, V4A, IP65, switchable

Set including converter for 230 V mains voltage, switchable, dimensions of converter: L 68 x W 35 x H 21 mm

Illuminants: LED, color rendering: CRI > 80, power: 6 W, beam angle: 38°, material: Stainless steel V4A / Aluminum / Glass / Plastic

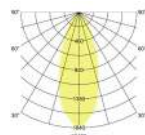

LED recessed downlight set, V4A, IP65, dimmable phase section

NEW

Set including converter for 230 V mains voltage, dimmable phase section, dimensions of converter: L 110 x W 50 x H 19 mm

Illuminants: LED, color rendering: CRI > 80, power: 6 W, beam angle: 38°, material: Stainless steel V4A / Aluminum / Glass / Plastic

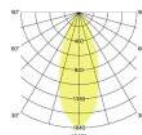

Item no.	Color	Luminous flux	Color temperature	Price €
38306423	Stainless steel	540 lm	3000 K	143.40

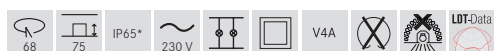

* IP65 when installed in closed ceilings

Item no.	Color	Luminous flux	Color temperature	Price €
39306423	NEW Stainless steel	540 lm	3000 K	147.30



* IP65 when installed in closed ceilings



LED recessed downlight, IP54

Illuminants: LED, model: Plug&Play, color rendering: CRI > 80, power: 6 W, beam angle: 38°, material: Aluminum / Glass

You will find the corresponding 350-mA converters from page 516 onwards.

Item no.	Color	Luminous flux	Color temperature	Price €
12266073	White	540 lm	2700 K	73.10
12266083	Black	540 lm	2700 K	73.10



* IP54 when installed in closed ceilings

LED recessed downlight set, IP54, switchable

Set including converter for 230 V mains voltage, switchable, dimensions of converter: L 68 x W 35 x H 21 mm

Illuminants: LED, color rendering: CRI > 80, power: 6 W, beam angle: 38°, material: Aluminum / Glass / Plastic

Item no.	Color	Luminous flux	Color temperature	Price €
38266073	White	540 lm	2700 K	96.60
38266083	Black	540 lm	2700 K	96.60

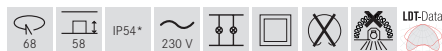

* IP54 when installed in closed ceilings

LED recessed downlight set, IP54, dimmable phase section

NEW

Set including converter for 230 V mains voltage, dimmable phase section, dimensions of converter: L 110 x W 50 x H 19 mm

Illuminants: LED, color rendering: CRI > 80, power: 6 W, beam angle: 38°, material: Aluminum / Glass / Plastic

Item no.	Color	Luminous flux	Color temperature	Price €
39266073	NEW White	540 lm	2700 K	100.50
39266083	NEW Black	540 lm	2700 K	100.50

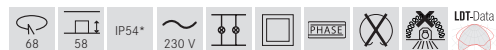

* IP54 when installed in closed ceilings

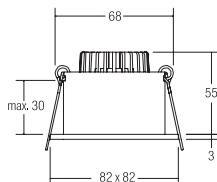

LED recessed downlight, IP54

Illuminants: LED, model: Plug&Play, color rendering: CRI > 80, power: 6 W, beam angle: 38°, material: Aluminum / Glass

You will find the corresponding 350-mA converters from page 516 onwards.

LED recessed downlight set, IP54, switchable

Set including converter for 230 V mains voltage, switchable, dimensions of converter: L 68 x W 35 x H 21 mm

Illuminants: LED, color rendering: CRI > 80, power: 6 W, beam angle: 38°, material: Aluminum / Glass / Plastic

Item no.	Color	Luminous flux	Color temperature	Price €
12267073	White	540 lm	2700 K	79.10
12267083	Black	540 lm	2700 K	79.10



* IP54 when installed in closed ceilings

Item no.	Color	Luminous flux	Color temperature	Price €
38267073	White	540 lm	2700 K	102.60
38267083	Black	540 lm	2700 K	102.60

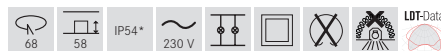

* IP54 when installed in closed ceilings

LED recessed downlight set, IP54, dimmable phase section

NEW

Set including converter for 230 V mains voltage, dimmable phase section, dimensions of converter: L 110 x W 50 x H 19 mm

Illuminants: LED, color rendering: CRI > 80, power: 6 W, beam angle: 38°, material: Aluminum / Glass / Plastic

Item no.	Color	Luminous flux	Color temperature	Price €
39267073	NEW White	540 lm	2700 K	106.50
39267083	NEW Black	540 lm	2700 K	106.50

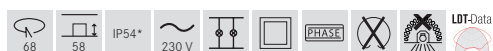

* IP54 when installed in closed ceilings

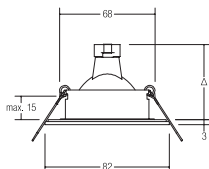

Recessed downlight, V4A, IP54, GX5.3

Illuminants: For LED retrofit lamp, model: GX5.3, power: maximum 35 W, material: Stainless steel V4A / Glass

Item no.	Color	Price €
26004070	White	58.00
26004220	Stainless steel	58.00

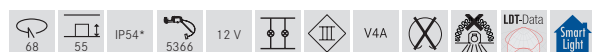

* IP54 when installed in closed ceilings

Recessed downlight, V4A, IP54, GU 10

Including bracket with GU10 holder for standard-compliant strain relief.

Illuminants: For LED retrofit lamp, model: GU10, power: maximum 35 W, material: Stainless steel V4A / Glass

Item no.	Color	Price €
36004070	White	69.00
36004220	Stainless steel	69.00

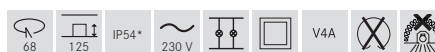

* IP54 when installed in closed ceilings

LED recessed downlight set BB15, V4A, IP54, switchable NEW

Set including converter for 230 V mains voltage, switchable, dimensions of converter: L 68 x W 35 x H 21 mm

Illuminants: LED, color rendering: CRI > 80, power: 6 W, beam angle: 38°, material: Stainless steel V4A / Aluminum / Glass / Plastic

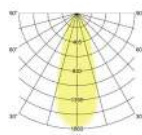

Item no.	Color	Luminous flux	Color temperature	Price €
38375073	NEW White	680 lm	3000 K	86.90
38375423	Stainless steel	680 lm	3000 K	86.90

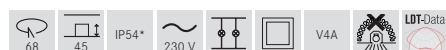

* IP54 when installed in closed ceilings

BB15 LED recessed downlight set, V4A, IP54, dimmable phase section

NEW

Set including converter for 230 V mains voltage, dimmable phase section, dimensions of converter: L 110 x W 50 x H 19 mm

Illuminants: LED, color rendering: CRI > 80, power: 6 W, beam angle: 38°, material: Stainless steel V4A / Aluminum / Glass / Plastic

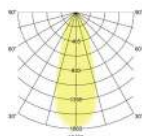

Item no.	Color	Luminous flux	Color temperature	Price €
39375073	NEW White	680 lm	3000 K	87.70
39375423	Stainless steel	680 lm	3000 K	87.70

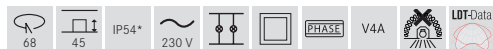

* IP54 when installed in closed ceilings

BB15 LED recessed downlight set, V4A, IP54, dimmable phase section, with connection box

NEW

Set including converter for 230 V mains voltage, dimmable phase section, dimensions of converter: L 110 x W 50 x H 19 mm

Illuminants: LED, color rendering: CRI > 80, power: 6 W, beam angle: 38°, material: Stainless steel V4A / Aluminum / Glass / Plastic, delivery: including connection box, 3-pin

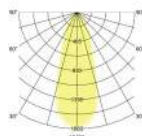

Item no.	Color	Luminous flux	Color temperature	Price €
39475073	NEW White	680 lm	3000 K	92.10
39475423	NEW Stainless steel	680 lm	3000 K	92.10

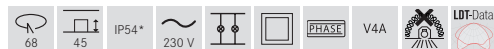

* IP54 when installed in closed ceilings

BB15 LED recessed downlight set, V4A, IP54, dimmable phase section (round converter)

NEW

Set including converter for 230 V mains voltage, dimmable phase section, dimensions of converter: D 51 x H 24 mm

Illuminants: LED, color rendering: CRI > 80, power: 6 W, beam angle: 38°, material: Stainless steel V4A / Aluminum / Glass / Plastic

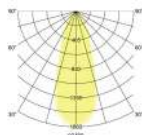

Item no.	Color	Luminous flux	Color temperature	Price €
40375073	NEW White	680 lm	3000 K	96.50
40375423	Stainless steel	680 lm	3000 K	96.50

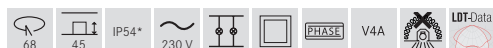

* IP54 when installed in closed ceilings

BB15 LED recessed downlight set, V4A, IP54, dimmable DALI, with connection box

NEW

Set including converter for 230 V mains voltage, dimmable DALI-2, dimensions of converter: L 130 x W 42 x H 22 mm

Illuminants: LED, color rendering: CRI > 80, power: 6 W, beam angle: 38°, material: Stainless steel V4A / Aluminum / Glass / Plastic, delivery: including connection box, 5-pin

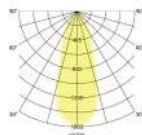

Item no.	Color	Luminous flux	Color temperature	Price €
41475073	NEW White	680 lm	3000 K	127.60
41475423	NEW Stainless steel	680 lm	3000 K	127.60

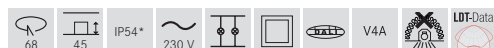

* IP54 when installed in closed ceilings

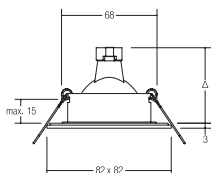

Recessed downlight, V4A, IP54, GX5.3

Illuminants: For LED retrofit lamp, model: GX5.3, power: maximum 35 W, material: Stainless steel V4A / Glass

Item no.	Color	Price €
26005070	White	60.40
26005220	Stainless steel	60.40

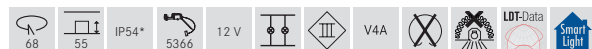

* IP54 when installed in closed ceilings

Recessed downlight, V4A, IP54, GU10

Including bracket with GU10 holder for standard-compliant strain relief.

Illuminants: For LED retrofit lamp, model: GU10, power: maximum 35 W, material: Stainless steel V4A / Glass

Item no.	Color	Price €
36005070	White	71.40
36005220	Stainless steel	71.40

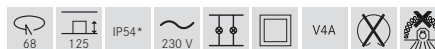

* IP54 when installed in closed ceilings

BB16 LED recessed downlight set, V4A, IP54, switchable NEW

Set including converter for 230 V mains voltage, switchable, dimensions of converter: L 68 x W 35 x H 21 mm

Illuminants: LED, color rendering: CRI > 80, power: 6 W, beam angle: 38°, material: Stainless steel V4A / Aluminum / Glass / Plastic

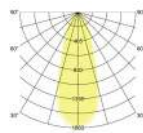

Item no.	Color	Luminous flux	Color temperature	Price €
38376073	NEW White	680 lm	3000 K	89.90
38376423	Stainless steel	680 lm	3000 K	89.90

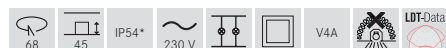

* IP54 when installed in closed ceilings

BB16 LED recessed downlight set, V4A, IP54, dimmable phase section

NEW

Set including converter for 230 V mains voltage, dimmable phase section, dimensions of converter: L 110 x W 50 x H 19 mm

Illuminants: LED, color rendering: CRI > 80, power: 6 W, beam angle: 38°, material: Stainless steel V4A / Aluminum / Glass / Plastic

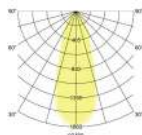

Item no.	Color	Luminous flux	Color temperature	Price €
39376073	NEW White	680 lm	3000 K	90.70
39376423	Stainless steel	680 lm	3000 K	90.70

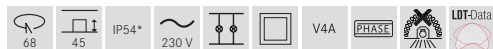

* IP54 when installed in closed ceilings

BB16 LED recessed downlight set, V4A, IP54, dimmable phase section, with connection box

NEW

Set including converter for 230 V mains voltage, dimmable phase section, dimensions of converter: L 110 x W 50 x H 19 mm

Illuminants: LED, color rendering: CRI > 80, power: 6 W, beam angle: 38°, material: Stainless steel V4A / Aluminum / Glass / Plastic, delivery: including connection box, 3-pin

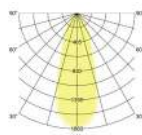

Item no.	Color	Luminous flux	Color temperature	Price €
39476073	NEW White	680 lm	3000 K	95.10
39476423	NEW Stainless steel	680 lm	3000 K	95.10

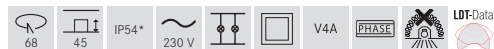

* IP54 when installed in closed ceilings

BB16 LED recessed downlight set, V4A, IP54, dimmable phase section (round converter)

NEW

Set including converter for 230 V mains voltage, dimmable phase section, dimensions of converter: D 51 x H 24 mm

Illuminants: LED, color rendering: CRI > 80, power: 6 W, beam angle: 38°, material: Stainless steel V4A / Aluminum / Glass / Plastic

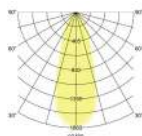

Item no.	Color	Luminous flux	Color temperature	Price €
40376073	NEW White	680 lm	3000 K	99.50
40376423	Stainless steel	680 lm	3000 K	99.50

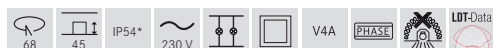

* IP54 when installed in closed ceilings

BB16 LED recessed downlight set, V4A, IP54, dimmable DALI, with connection box

NEW

Set including converter for 230 V mains voltage, dimmable DALI-2, dimensions of converter: L 130 x W 42 x H 22 mm

Illuminants: LED, color rendering: CRI > 80, power: 6 W, beam angle: 38°, material: Stainless steel V4A / Aluminum / Glass / Plastic, delivery: including connection box, 5-pin

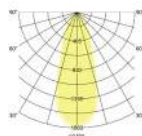

Item no.	Color	Luminous flux	Color temperature	Price €
41476073	NEW White	680 lm	3000 K	130.60
41476423	NEW Stainless steel	680 lm	3000 K	130.60

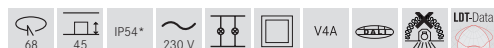

* IP54 when installed in closed ceilings

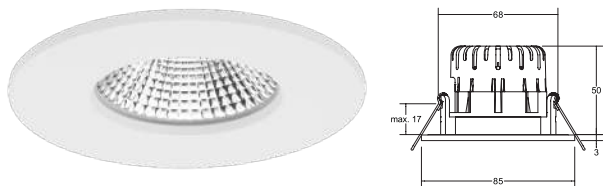

BB20 LED recessed downlight set, IP65, switchable NEW

Set including converter for 230 V mains voltage, switchable, dimensions of converter: L 68 x W 35 x H 21 mm

Illuminants: LED, color rendering: CRI > 80, power: 7 W, beam angle: 36°, material: Aluminum / Plastic

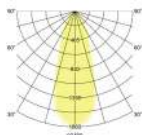

Item no.	Color	Luminous flux	Color temperature	Price €
38480153	NEW Nickel matte	620 lm	3000 K	66.90
38480173	NEW Structural white	620 lm	3000 K	59.90
38480183	NEW Structural black	620 lm	3000 K	59.90



* IP65 when installed in closed ceilings

BB20 LED recessed downlight set, IP65, dimmable phase section NEW

Set including converter for 230 V mains voltage, dimmable phase section, dimensions of converter: L 110 x W 50 x H 19 mm

Illuminants: LED, color rendering: CRI > 80, power: 7 W, beam angle: 36°, material: Aluminum / Plastic

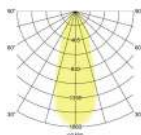

Item no.	Color	Luminous flux	Color temperature	Price €
39480153	NEW Nickel matte	620 lm	3000 K	69.00
39480173	NEW Structural white	620 lm	3000 K	62.00
39480183	NEW Structural black	620 lm	3000 K	62.00



* IP65 when installed in closed ceilings

BB20 LED recessed downlight set, IP65, dimmable phase section (round converter) NEW

Set including converter for 230 V mains voltage, dimmable phase section, dimensions of converter: D 51 x H 24 mm

Illuminants: LED, color rendering: CRI > 80, power: 7 W, beam angle: 36°, material: Aluminum / Plastic

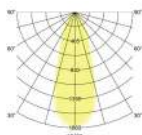

Item no.	Color	Luminous flux	Color temperature	Price €
40480153	NEW Nickel matte	620 lm	3000 K	77.30
40480173	NEW Structural white	620 lm	3000 K	70.30
40480183	NEW Structural black	620 lm	3000 K	70.30



* IP65 when installed in closed ceilings

BB20 LED recessed downlight set, IP65, dimmable DALI, with connection box NEW

Set including converter for 230 V mains voltage, dimmable DALI-2, dimensions of converter: L 130 x W 42 x H 22 mm

Illuminants: LED, color rendering: CRI > 80, power: 7 W, beam angle: 36°, material: Aluminum / Plastic, Delivery: including connection box, 5-pin

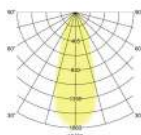

Item no.	Color	Luminous flux	Color temperature	Price €
41480153	NEW Nickel matte	620 lm	3000 K	109.60
41480173	NEW Structural white	620 lm	3000 K	102.60
41480183	NEW Structural black	620 lm	3000 K	102.60



* IP65 when installed in closed ceilings

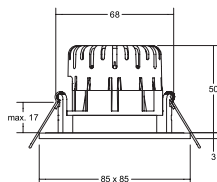
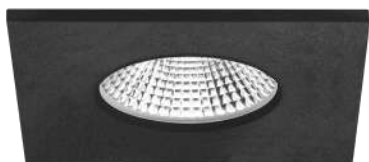

BB21 LED recessed downlight set, IP65, switchable

NEW

Set including converter for 230 V mains voltage, switchable, dimensions of converter: L 68 x W 35 x H 21 mm

Illuminants: LED, color rendering: CRI > 80, power: 7 W, beam angle: 36°, material: Aluminum / Plastic

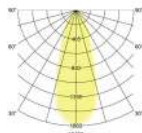

Item no.	Color	Luminous flux	Color temperature	Price €
38481153	NEW Nickel matte	620 lm	3000 K	67.90
38481173	NEW Structural white	620 lm	3000 K	60.90
38481183	NEW Structural black	620 lm	3000 K	60.90



* IP65 when installed in closed ceilings

BB21 LED recessed downlight set, IP65, dimmable phase section

NEW

Set including converter for 230 V mains voltage, dimmable phase section, dimensions of converter: L 110 x W 50 x H 19 mm

Illuminants: LED, color rendering: CRI > 80, power: 7 W, beam angle: 36°, material: Aluminum / Plastic

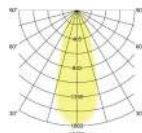

Item no.	Color	Luminous flux	Color temperature	Price €
39481153	NEW Nickel matte	620 lm	3000 K	70.00
39481173	NEW Structural white	620 lm	3000 K	63.00
39481183	NEW Structural black	620 lm	3000 K	63.00



* IP65 when installed in closed ceilings

BB21 LED recessed downlight set, IP65, dimmable phase section (round converter)

NEW

Set including converter for 230 V mains voltage, dimmable phase section, dimensions of converter: D 51 x H 24 mm

Illuminants: LED, color rendering: CRI > 80, power: 7 W, beam angle: 36°, material: Aluminum / Plastic

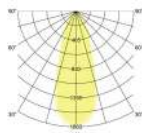

Item no.	Color	Luminous flux	Color temperature	Price €
40481153	NEW Nickel matte	620 lm	3000 K	78.30
40481173	NEW Structural white	620 lm	3000 K	71.30
40481183	NEW Structural black	620 lm	3000 K	71.30



* IP65 when installed in closed ceilings

BB21 LED recessed downlight set, IP65, dimmable DALI, with connection box

NEW

Set including converter for 230 V mains voltage, dimmable DALI-2, dimensions of converter: L 130 x W 42 x H 22 mm

Illuminants: LED, color rendering: CRI > 80, power: 7 W, beam angle: 36°, material: Aluminum / Plastic, Delivery: including connection box, 5-pin

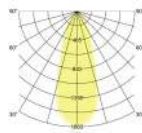

Item no.	Color	Luminous flux	Color temperature	Price €
41481153	NEW Nickel matte	620 lm	3000 K	110.60
41481173	NEW Structural white	620 lm	3000 K	103.60
41481183	NEW Structural black	620 lm	3000 K	103.60



* IP65 when installed in closed ceilings



BB23 LED recessed spotlight set, IP65, switchable NEW

Set including converter for 230 V mains voltage, switchable, dimensions of converter: L 68 x W 35 x H 21 mm

Illuminants: LED, color rendering: CRI > 80, power: 7 W, beam angle: 36°, material: Aluminum / Plastic

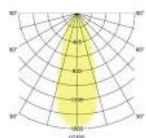

Item no.	Color	Luminous flux	Color temperature	Price €
38484153 NEW	Nickel matte	620 lm	3000 K	69.90
38484173 NEW	Structural white	620 lm	3000 K	62.90
38484183 NEW	Structural black	620 lm	3000 K	62.90



* IP65 when installed in closed ceilings

BB23 LED recessed spotlight set, IP65, dimmable phase section NEW

Set including converter for 230 V mains voltage, dimmable phase section, dimensions of converter: L 110 x W 50 x H 19 mm

Illuminants: LED, color rendering: CRI > 80, power: 7 W, beam angle: 36°, material: Aluminum / Plastic

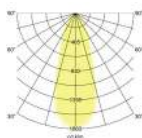

Item no.	Color	Luminous flux	Color temperature	Price €
39484153 NEW	Nickel matte	620 lm	3000 K	72.00
39484173 NEW	Structural white	620 lm	3000 K	65.00
39484183 NEW	Structural black	620 lm	3000 K	65.00



* IP65 when installed in closed ceilings

BB23 LED recessed spotlight set, IP65, dimmable phase section (round converter) NEW

Set including converter for 230 V mains voltage, dimmable phase section, dimensions of converter: D 51 x H 24 mm

Illuminants: LED, color rendering: CRI > 80, power: 7 W, beam angle: 36°, material: Aluminum / Plastic

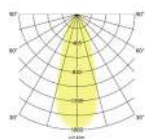

Item no.	Color	Luminous flux	Color temperature	Price €
40484153 NEW	Nickel matte	620 lm	3000 K	80.30
40484173 NEW	Structural white	620 lm	3000 K	73.30
40484183 NEW	Structural black	620 lm	3000 K	73.30



* IP65 when installed in closed ceilings

BB23 LED recessed spotlight, IP65, dimmable DALI, with connection box NEW

Set including converter for 230 V mains voltage, dimmable DALI-2, dimensions of converter: L 130 x W 42 x H 22 mm

Illuminants: LED, color rendering: CRI > 80, power: 7 W, beam angle: 36°, material: Aluminum / Plastic, Delivery: including connection box, 5-pin

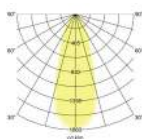

Item no.	Color	Luminous flux	Color temperature	Price €
41484153 NEW	Nickel matte	620 lm	3000 K	112.60
41484173 NEW	Structural white	620 lm	3000 K	105.60
41484183 NEW	Structural black	620 lm	3000 K	105.60



* IP65 when installed in closed ceilings

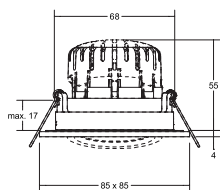

BB25 LED recessed spotlight set, IP65, switchable

NEW

Set including converter for 230 V mains voltage, switchable, dimensions of converter: L 68 x W 35 x H 21 mm

Illuminants: LED, color rendering: CRI > 80, power: 7 W, beam angle: 36°, material: Aluminum / Plastic

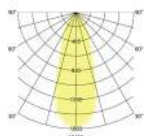

Item no.	Color	Luminous flux	Color temperature	Price €
38488153	NEW Nickel matte	620 lm	3000 K	70.90
38488173	NEW Structural white	620 lm	3000 K	63.90
38488183	NEW Structural black	620 lm	3000 K	63.90



* IP65 when installed in closed ceilings

BB25 LED recessed spotlight set, IP65, dimmable phase section

NEW

Set including converter for 230 V mains voltage, dimmable phase section, dimensions of converter: L 110 x W 50 x H 19 mm

Illuminants: LED, color rendering: CRI > 80, power: 7 W, beam angle: 36°, material: Aluminum / Plastic

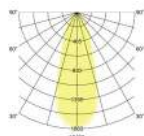

Item no.	Color	Luminous flux	Color temperature	Price €
39488153	NEW Nickel matte	620 lm	3000 K	73.00
39488173	NEW Structural white	620 lm	3000 K	66.00
39488183	NEW Structural black	620 lm	3000 K	66.00



* IP65 when installed in closed ceilings

BB25 LED recessed spotlight set, IP65, dimmable phase section (round converter)

NEW

Set including converter for 230 V mains voltage, dimmable phase section, dimensions of converter: D 51 x H 24 mm

Illuminants: LED, color rendering: CRI > 80, power: 7 W, beam angle: 36°, material: Aluminum / Plastic

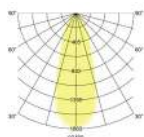

Item no.	Color	Luminous flux	Color temperature	Price €
40488153	NEW Nickel matte	620 lm	3000 K	81.30
40488173	NEW Structural white	620 lm	3000 K	74.30
40488183	NEW Structural black	620 lm	3000 K	74.30



* IP65 when installed in closed ceilings

BB25 LED recessed spotlight, IP65, dimmable DALI, with connection box

NEW

Set including converter for 230 V mains voltage, dimmable DALI-2, dimensions of converter: L 130 x W 42 x H 22 mm

Illuminants: LED, color rendering: CRI > 80, power: 7 W, beam angle: 36°, material: Aluminum / Plastic, Delivery: including connection box, 5-pin

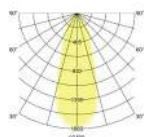

Item no.	Color	Luminous flux	Color temperature	Price €
41488153	NEW Nickel matte	620 lm	3000 K	113.60
41488173	NEW Structural white	620 lm	3000 K	106.60
41488183	NEW Structural black	620 lm	3000 K	106.60



* IP65 when installed in closed ceilings

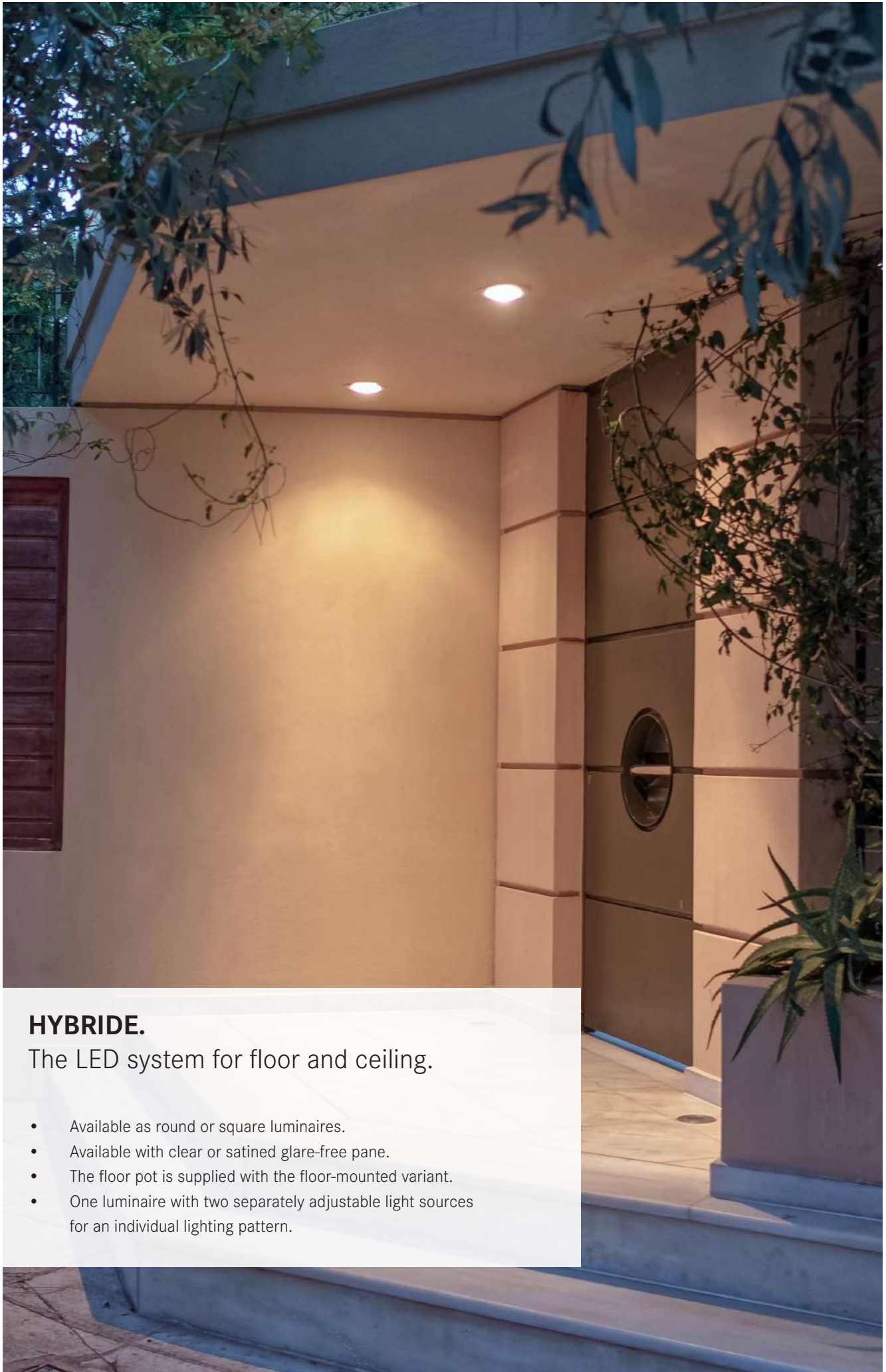

HYBRIDE.

The LED system for floor and ceiling.

- Available as round or square luminaires.
- Available with clear or satined glare-free pane.
- The floor pot is supplied with the floor-mounted variant.
- One luminaire with two separately adjustable light sources for an individual lighting pattern.



HYBRIDE LED recessed downlight, V4A, IP67

Illuminants: LED, color rendering: CRI > 80, power: 8 W, beam angle: 38°, material: Stainless steel V4A / Aluminum / Glass, delivery: including converter for connection with 230 V mains voltage, switchable and 5,000-mm connection cable

You will find hybrid floor variants on page 491.

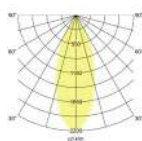

Item no.	Color	Luminous flux	Color temperature	Price €
12660223	Stainless steel	860 lm	3000 K	306.20



HYBRIDE LED recessed downlight, V4A, IP67

Illuminants: LED, color rendering: CRI > 80, power: 7 W, beam angle: 117°, material: Stainless steel V4A / Aluminum / Glass, delivery: including converter for connection with 230 V mains voltage, switchable and 5,000-mm connection cable

You will find hybrid floor variants on page 491.

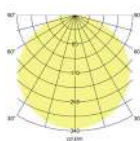

Item no.	Color	Luminous flux	Color temperature	Price €
12661223	Stainless steel	350 lm	3000 K	279.90



HYBRIDE LED recessed downlight, V4A, IP67

Illuminants: LED, color rendering: CRI > 80, power: 13 W, beam angle: 40°, material: Stainless steel V4A / Aluminum / Glass, delivery: including converter for connection with 230 V mains voltage, switchable and 5,000-mm connection cable

You will find hybrid floor variants on page 491.

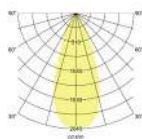

Item no.	Color	Luminous flux	Color temperature	Price €
12662223	Stainless steel	1,400 lm	3000 K	378.60



HYBRIDE LED recessed downlight, V4A, IP67

Illuminants: LED, color rendering: CRI > 80, power: 17 W, beam angle: 34°, material: Stainless steel V4A / Aluminum / Glass, delivery: including converter for connection with 230 V mains voltage, switchable and 5,000-mm connection cable

You will find hybrid floor variants on page 491.

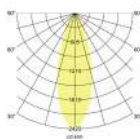

Item no.	Color	Luminous flux	Color temperature	Price €
12664223	Stainless steel	2,010 lm	3000 K	449.90



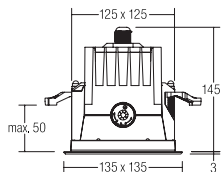

HYBRIDE LED recessed spotlight, V4A, IP67

Illuminants: LED, color rendering: CRI > 80, power: 4.5 W, beam angle: 30°, luminous flux: 2 x 335 lm, material: Stainless steel V4A / Aluminum / Glass, delivery: including converter for connection with 230 V mains voltage, switchable, 5,000-mm connection cable and setting tool

You will find hybrid floor variants on page 489.

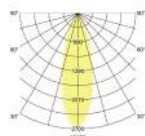

Two light sources can be individually set:

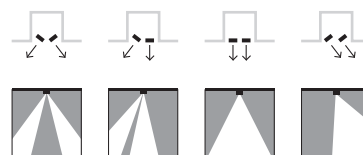

Setting tool is included in the scope of delivery |

Item no.	Color	Luminous flux	Color temperature	Price €
12678223	Stainless steel	670 lm	3000 K	361.10

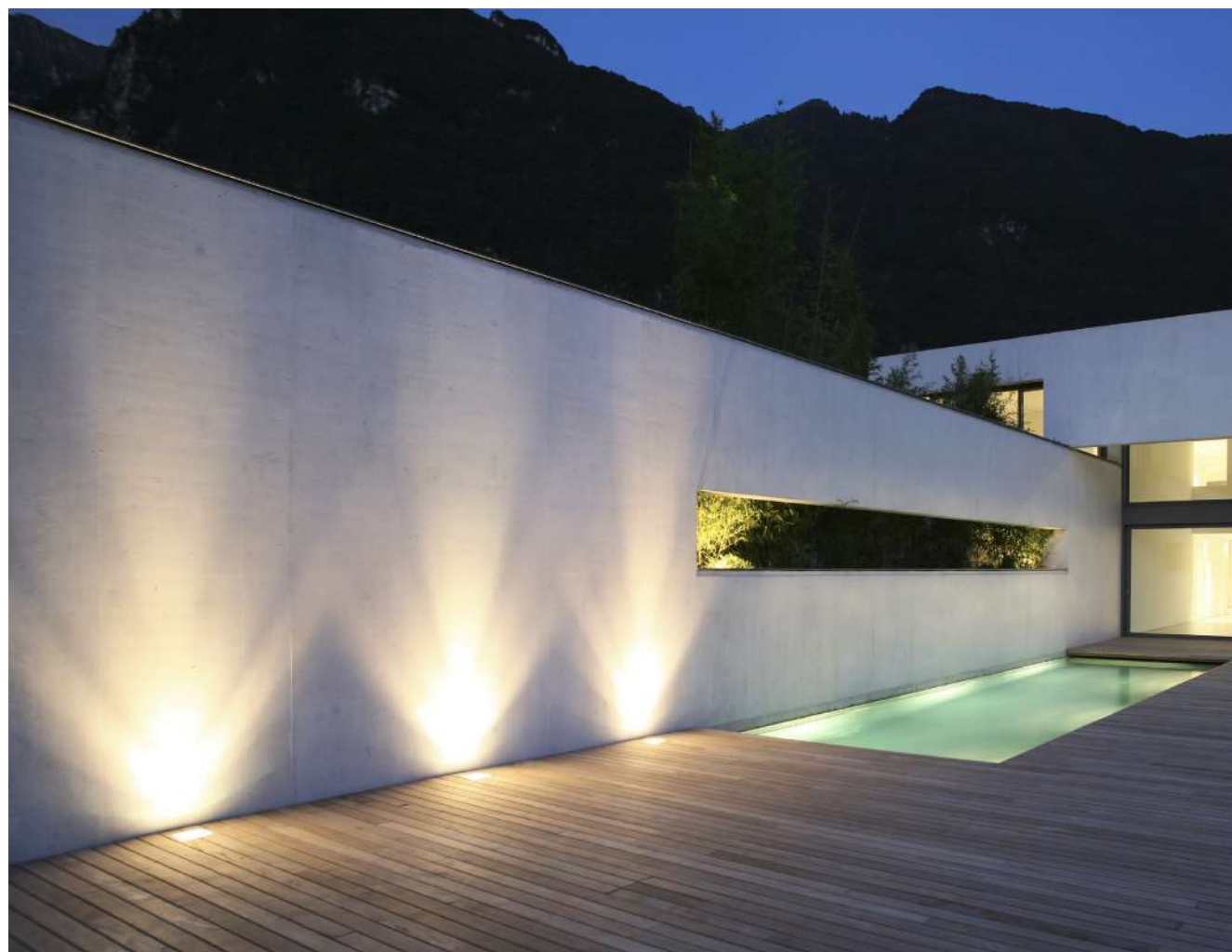



HYBRIDE LED recessed downlight, V4A, IP67

Illuminants: LED, color rendering: CRI > 80, power: 9 W, beam angle: 40°, material: Stainless steel V4A / Aluminum / Glass, delivery: including converter for connection with 230 V mains voltage, switchable and 5,000-mm connection cable

You will find hybrid floor variants on page 490.

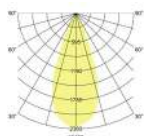

Item no.	Color	Luminous flux	Color temperature	Price €
12670223	Stainless steel	460 lm	3000 K	306.20



HYBRIDE LED recessed downlight, V4A, IP67

Illuminants: LED, color rendering: CRI > 80, power: 11 W, beam angle: 117°, material: Stainless steel V4A / Aluminum / Glass, delivery: including converter for connection with 230 V mains voltage, switchable and 5,000-mm connection cable

You will find hybrid floor variants on page 490.

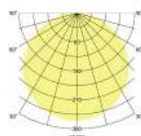

Item no.	Color	Luminous flux	Color temperature	Price €
12671223	Stainless steel	550 lm	3000 K	279.90



HYBRIDE LED recessed downlight, V4A, IP67

Illuminants: LED, color rendering: CRI > 80, power: 10 W, beam angle: 37°, material: Stainless steel V4A / Aluminum / Glass, delivery: including converter for connection with 230 V mains voltage, switchable and 5,000-mm connection cable

You will find hybrid floor variants on page 490.

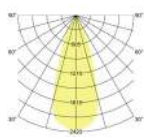

Item no.	Color	Luminous flux	Color temperature	Price €
12672223	Stainless steel	720 lm	3000 K	395.00



HYBRIDE LED recessed downlight, V4A, IP67

Illuminants: LED, color rendering: CRI > 80, power: 10 W, beam angle: 115°, material: Stainless steel V4A / Aluminum / Glass, delivery: including converter for connection with 230 V mains voltage, switchable and 5,000-mm connection cable

You will find hybrid floor variants on page 490.

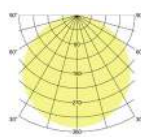

Item no.	Color	Luminous flux	Color temperature	Price €
12673223	Stainless steel	710 lm	3000 K	338.00





FLAT30 LED recessed panel

Illuminants: LED, color rendering: CRI > 80, power: 10 W, beam angle: 120°, material: Aluminum / Plastic

You will find corresponding 24 V power supplies from page 532 onwards.

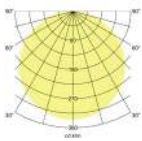

Item no.	Color	Luminous flux	Color temperature	Price €
12215073	White	580 lm	3000 K	48.90
12215683	Silver	580 lm	3000 K	48.90
12215074	White	600 lm	4000 K	48.90
12215684	Silver	600 lm	4000 K	48.90

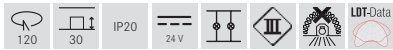

FLAT30 LED recessed panel, TunableWhite

Illuminants: LED, color rendering: CRI > 80, power: 12 W, beam angle: 120°, material: Aluminum / Plastic, Luminous flux: 2700 K: 350 lm, 5700 K: 420 lm

You will find corresponding 24 V power supplies on page 532 and corresponding controllers from page 536 onwards.

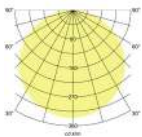

Item no.	Color	Color temperature	Price €
12435074	White	2700 K - 5700 K	60.50
12435684	Silver	2700 K - 5700 K	60.50

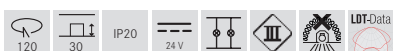



FLAT30 LED recessed panel

Illuminants: LED, color rendering: CRI > 80, power: 16 W, beam angle: 120°, material: Aluminum / Plastic

You will find corresponding 24 V power supplies from page 532 onwards.

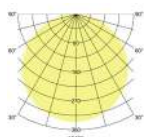

Item no.	Color	Luminous flux	Color temperature	Price €
12217073	White	1,040 lm	3000 K	73.00
12217683	Silver	1,040 lm	3000 K	73.00
12217074	White	1,080 lm	4000 K	73.00
12217684	Silver	1,080 lm	4000 K	73.00

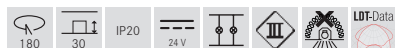

FLAT30 LED recessed panel, TunableWhite

Illuminants: LED, color rendering: CRI > 80, power: 20 W, beam angle: 120°, material: Aluminum / Plastic, Luminous flux: 2700 K: 550 lm, 5700 K: 760 lm

You will find corresponding 24 V power supplies on page 532 and corresponding controllers from page 536 onwards.

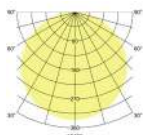

Item no.	Color	Color temperature	Price €
12437074	White	2700 K - 5700 K	93.30
12437684	Silver	2700 K - 5700 K	93.30

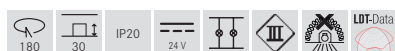



MOON.

Simple installation, flexible bore hole.

Moon comes in three sizes with replaceable front ring and offers three wattages with different lumen packages depending on the size. In addition, the color temperature can be adjusted on site to 3000, 4000 or 6000 Kelvin. The variable bore hole ensures uncomplicated installation. In addition, the luminaire is suitable for screw mounting (surface mounting) and spring mounting (recessed mounting). Moon is ideal for floor, passage or waiting areas, as well as small bathrooms and hallways.

To the product
video.



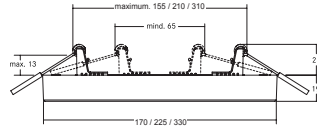

∅ 170 mm

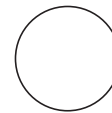

∅ 225 mm

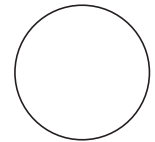

∅ 330 mm

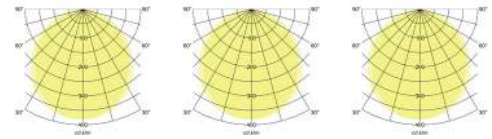

MOON LED recessed panel, dimmable phase section

NEW

The luminaire can be used as recessed as well as surface-mounted panel.

Illuminants: LED, color: white, color rendering: CRI > 80, beam angle: 110 °, material: Aluminum / plastic, delivery: including converter for connection with 230 V mains voltage, dimmable phase section.

Optional accessory: Front rings (see below), for modification of the housing color (magnetic attachment)

Sizes: Three sizes allow a flexible integration of different lumen ranges from 1,135 lm to 2,760 lm.

Item no.	Performance	Luminous flux	Color temperature	Ceiling cut-out*	Installation depth*	Height	Diameter	Price €
12205073 NEW	12 W	1,135 lm	3000 K / 4000 K / 6000 K	minimum 65 mm, maximum 155 mm	25 mm	19 mm	170 mm	45.40
12206073 NEW	18 W	1,672 lm	3000 K / 4000 K / 6000 K	minimum 65 mm, maximum 210 mm	25 mm	19 mm	225 mm	63.50
12207073 NEW	24 W	2,760 lm	3000 K / 4000 K / 6000 K	minimum 65 mm, maximum 310 mm	25 mm	19 mm	330 mm	94.90

* for recessed mounting

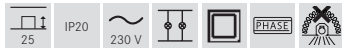

Chromium



Black



Nickel matte

Front rings: Color selection (magnetic attachment)

Item no.	Description	Price €
81020502 NEW	Front ring for 12205... chromium, round	13.70
81020508 NEW	Front ring for 12205... black, round	13.70
81020515 NEW	Front ring for 12205... nickel matte, round	13.70
81020602 NEW	Front ring for 12206... chromium, round	15.80
81020608 NEW	Front ring for 12206... black, round	15.80
81020615 NEW	Front ring for 12206... nickel matte, round	15.80
81020702 NEW	Front ring for 12207... chromium, round	21.10
81020708 NEW	Front ring for 12207... black, round	21.10
81020715 NEW	Front ring for 12207... nickel matte, round	21.10

Recessed mounting: Luminaires can be installed very easily thanks to the integrated fuse suspension. Luminaires can be installed by one person, as the fuse suspension is hooked onto the spring. The round cut-out can be flexibly adjusted on the luminaire. This allows it to be used in an existing hole size from 65 to a maximum of 310 millimeters.

Surface mounting: First, the supplied installation springs are removed. The luminaire can be easily attached to the ceiling with the mounting bracket.



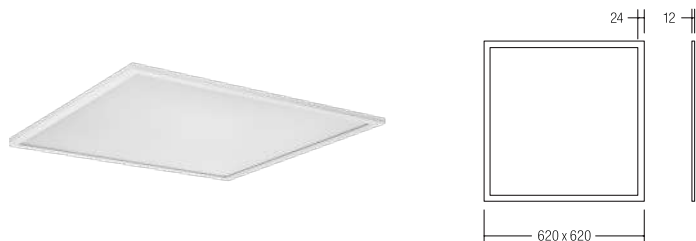

LED panel 620 x 620 mm

NEW

Illuminants: LED, color: white, dimensions: 620 x 620 mm, input voltage: 220 - 240 V AC, 50 - 60 Hz, power: 36 W (microprismatic), 37 W (opal), color rendering: CRI > 80, material: Aluminum
 Light current conservation:
 32045... & 32047...: L80/B50, > 50,000 hours (ta: +25 °C)
 32046... & 32048...: L80/B50, > 30,000 hours (ta: +25 °C)

Microprismatic

Opal

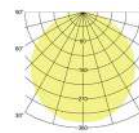
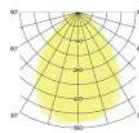

Item no.		Color temperature	Luminous flux	Cover	UGR	Controlling	Price €
32045073	NEW	3000 K	3,769 lm	Microprism	< 19	Switchable	112.00
32045074	NEW	4000 K	3,980 lm	Microprism	< 19	Switchable	112.00
32046073	NEW	3000 K	3,359 lm	Opal		Switchable	95.00
32046074	NEW	4000 K	3,591 lm	Opal		Switchable	95.00
32047073	NEW	3000 K	3,769 lm	Microprism	< 19	DALI	155.00
32047074	NEW	4000 K	3,980 lm	Microprism	< 19	DALI	155.00
32048073	NEW	3000 K	3,359 lm	Opal		DALI	138.00
32048074	NEW	4000 K	3,591 lm	Opal		DALI	138.00

These items are subject to discount group 2.

Switchable Multilumen setting for controller:

Item no.	Step 1 (900 mA)		Step 2 (950 mA)		Step 3 (1,000 mA)		Step 4 (1.050 mA)	
	Light output (lm)	System power (W)	Light output (lm)	System power (W)	Light output (lm)	System power (W)	Light output (lm)	System power (W)
32045073	3,588	36	3,769	38	3,948	40	4,125	42
32045074	3,789	36	3,980	38	4,169	40	4,357	42
32046073	3,208	37	3,359	39	3,506	41	3,652	43
32046074	3,430	37	3,591	39	3,749	41	3,905	43

Different steps are set using dip switches on the converter.

Default setting: Step 2.

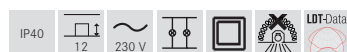

These items are subject to discount group 2.



Surface-mounting frame, Basic 625 x 625 mm, white

Height: 73 mm

Item no.	Price €
81032040	49.90

This item is subject to discount group 2.



Rope suspension, 4 x suspensions per 1,500 mm

Item no.	Price €
81032042	16.50

This item is subject to discount group 2.



Surface-mounting frame, Premium 625 x 625 mm, white

Height: 56 mm

NEW

Item no.	Price €
81036070	NEW 121.80

This item is subject to discount group 2.

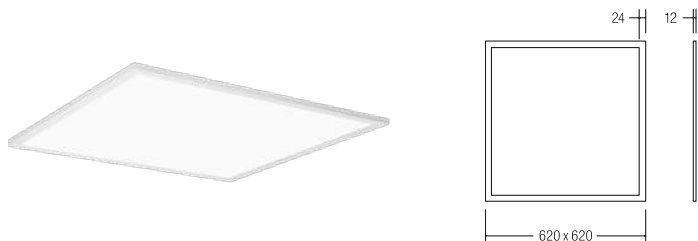

LED panel 620 x 620 mm, TunableWhite NEW

Illuminants: LED, color: white, dimensions: 620 x 620 mm, input voltage: 220 - 240 V AC, 50 - 60 Hz, power: 31 W, color rendering: CRI > 80, material: Aluminum, light current conservation: L70/B10, 50,000 hours (ta: +25 °C)

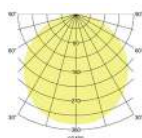

Item no.	Color temperature	Luminous flux	Cover	UGR	Controlling	Price €
32049074 NEW	3000 K - 6000 K	3,084 lm	Opal	< 19	DALI-DTB	317.00

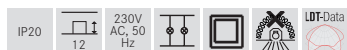

This item is subject to discount group 2.

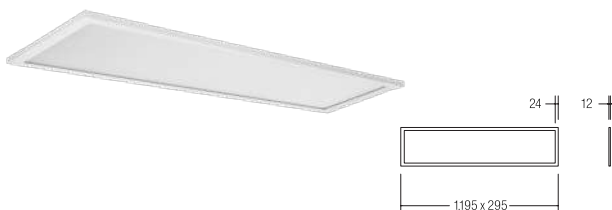

LED panel 1,195 x 295 mm

Illuminants: LED, color rendering: CRI > 80, glare rating: UGR < 19, power: 42 W, beam angle: 120°, material: Aluminum / polycarbonate, delivery: including microprismatic cover

Light current conservation: L70/B50, 50,000 hours (ta: +25 °C)

Set including converter for 230 V mains voltage, switchable, dimensions of converter: L 145 x B 43 x H 30 mm

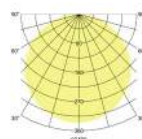

Item no.	Color temperature	Luminous flux	Cover	UGR	Controlling	Price €
12089003	3000 K	4,020 lm	Microprism	< 19	Switchable	145.00
12089004	4000 K	4,310 lm	Microprism	< 19	Switchable	145.00

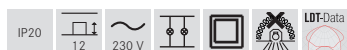

These items are subject to discount group 2.



Mounting frame, white, 1,200 x 300 mm NEW

Height: 50 mm

Item no.	Price €
81037070 NEW	127.10

This item is subject to discount group 2.



Rope suspension, 6 x suspensions per 1,500 mm

Item no.	Price €
81089000	30.00

This item is subject to discount group 2.





Showroom: Veenendaal (NL)

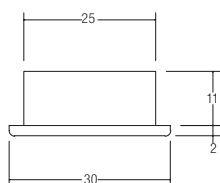

LED light point

Illuminants: LED, model: Plug&Play, power: 1 W, beam angle: 100°, material: Aluminum / Plastic

You will find the corresponding 350-mA converters from page 516 onwards.

Item no.	Color	Luminous flux	Color temperature	Price €
P3605WW	Chromium	40 lm	3000 K	29.00

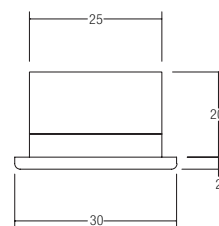
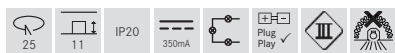

LED light point, IP43

Illuminants: LED, model: Plug&Play, power: 1 W, beam angle: 30°, material: Aluminum / Plastic

You will find the corresponding 350-mA converters from page 516 onwards.

Item no.	Color	Luminous flux	Color temperature	Price €
P3653WW	Chromium	40 lm	3000 K	34.10



* IP43 when installed in closed ceilings, only indoor.

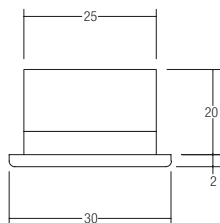

LED light point, IP43

Illuminants: LED, model: Plug&Play, power: 1 W, beam angle: 15°, material: Aluminum / Plastic

You will find the corresponding 350-mA converters from page 516 onwards.

Item no.	Color	Luminous flux	Color temperature	Price €
P3654WW	Chromium	40 lm	3000 K	34.10



* IP43 when installed in closed ceilings, only indoor.

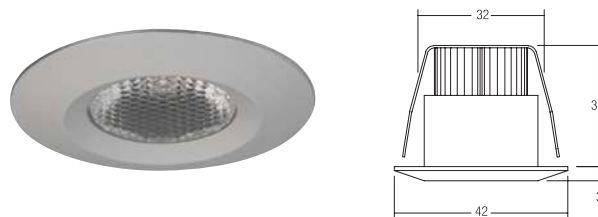

LED light point, IP44

Illuminants: LED, model: Plug&Play, color rendering: CRI > 80, power: 1.2 W, beam angle: 30°, material: Aluminum / Plastic

You will find the corresponding 350-mA converters from page 516 onwards.

LED light point, IP44

Illuminants: LED, model: Plug&Play, color rendering: CRI > 80, power: 1.2 W, beam angle: 36°, material: Aluminum / Plastic

You will find the corresponding 350-mA converters from page 516 onwards.

Item no.	Color	Luminous flux	Color temperature	Price €
12071023	Chromium	70 lm	3000 K	34.70
12071073	White	70 lm	3000 K	33.90
12071253	Aluminum matte	70 lm	3000 K	34.70

Item no.	Color	Luminous flux	Color temperature	Price €
12070253	Aluminum matte	70 lm	3000 K	29.70

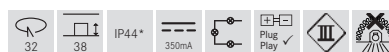

* IP44 when installed in closed ceilings

* IP44 when installed in closed ceilings



LED light point, IP65

NEW

Illuminants: LED, model: Plug&Play, color rendering: CRI > 80, power: 3 W, beam angle: 45°, material: Aluminum / Plastic

You will find the corresponding 700-mA converters from page 524 onwards.

Item no.	Color	Luminous flux	Color temperature	Price €
12053173	Structural white	120 lm	3000 K	74.50
12053183	NEW Structural black	120 lm	3000 K	74.50



* IP65 when installed in closed ceilings

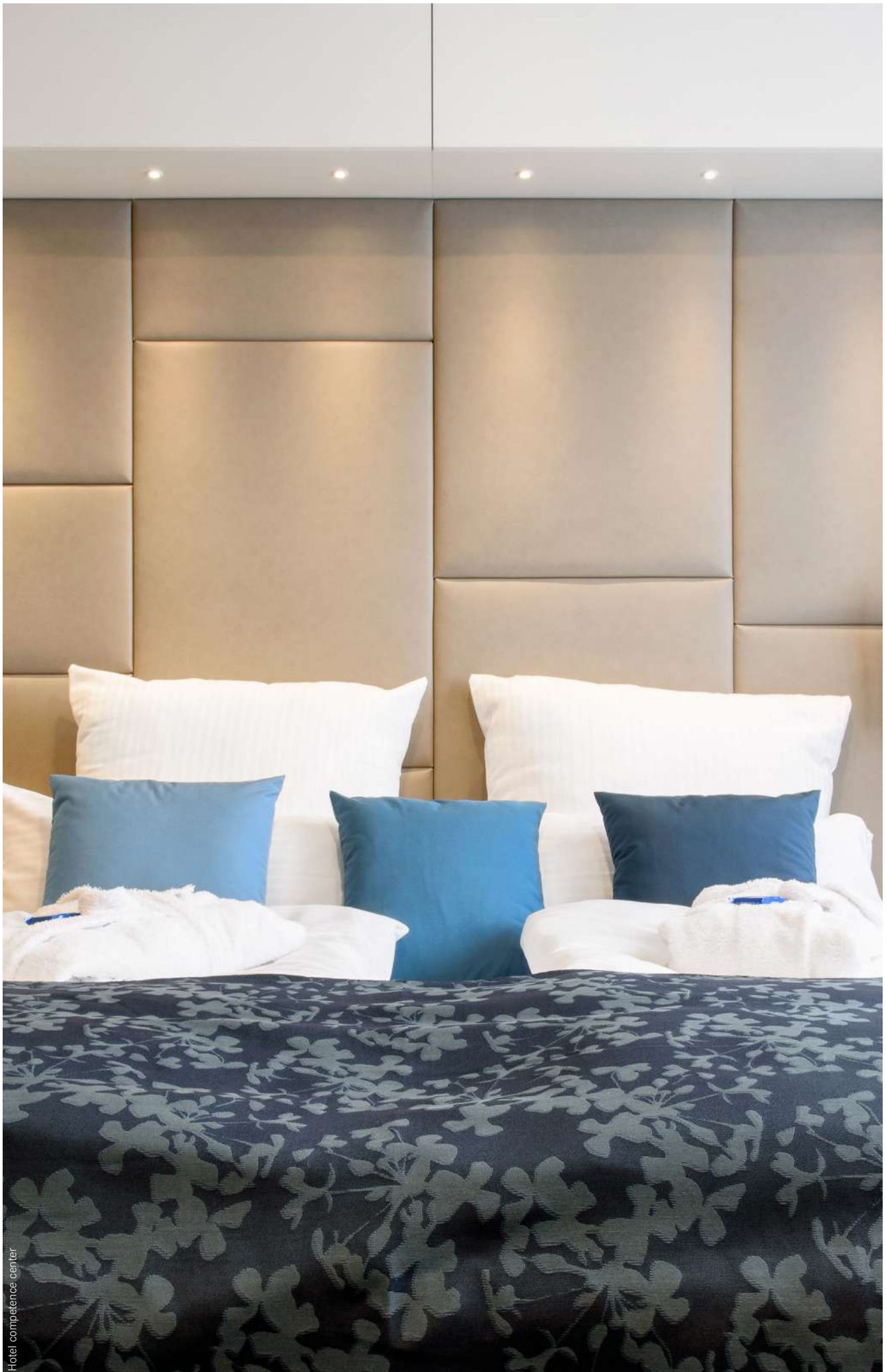

Hotel competence center

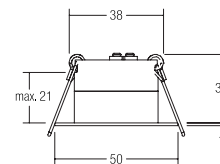
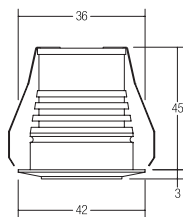

LED light point, IP44

Illuminants: LED, model: Plug&Play, power: 1 W, beam angle: 120°, material: Stainless steel / Glass

You will find the corresponding 350-mA converters from page 516 onwards.

Item no.	Color	Luminous flux	Color temperature	Price €
P3659WW	Stainless steel	40 lm	3000 K	89.20



* IP44 when installed in closed ceilings

LED light point, IP44

Illuminants: LED, model: Plug&Play, color rendering: CRI > 80, power: 3.3 W, beam angle: 32°, material: Stainless steel / Aluminum / Plastic

You will find the corresponding 350-mA converters from page 516 onwards.

Item no.	Color	Luminous flux	Color temperature	Price €
12079023	Chromium	160 lm	3000 K	57.20
12079073	White	160 lm	3000 K	44.50

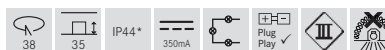

* IP44 when installed in closed ceilings

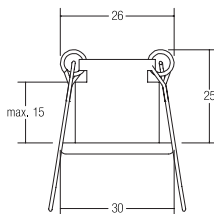

Light point, G4

Illuminants: For LV halogen lamp, model: G4, power: maximum 20 W, material: Cast

Item no.	Color	Price €
2030.02	Chromium	9.50
2030.03	Chromium matte	11.50
2030.05	Gold	10.50
2030.07	White	8.90



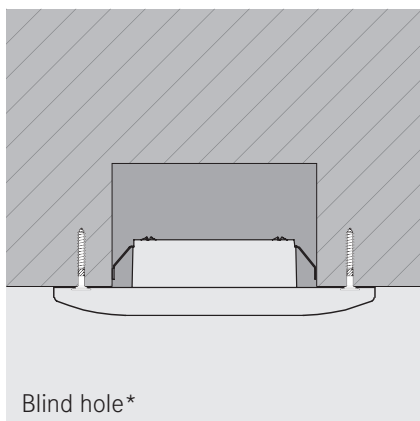

Blind hole*

*Power supply with luminaire can be mounted in the opening

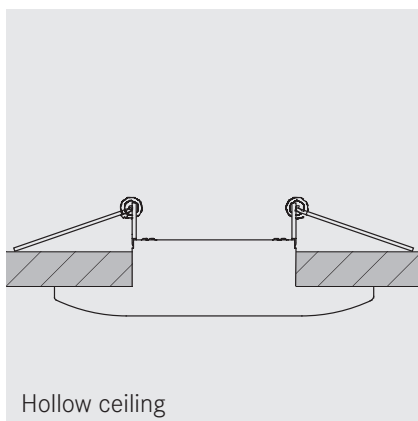

Hollow ceiling

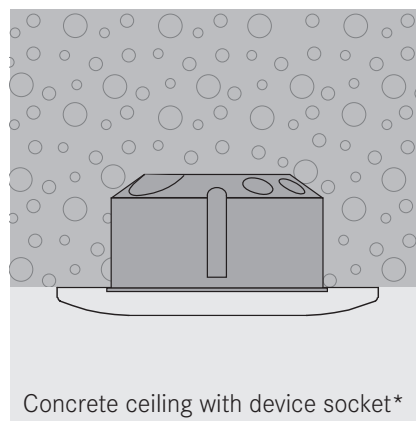

Concrete ceiling with device socket*

* Screw spacing 60 mm

ADAPT.

Problem solver for special installation situations.

The name says it all: Adapt is designed for installation in various mounting scenarios - as spring or screw mounting, for hollow ceilings and housing mounting. With its five different surfaces, it fits right into every room concept. These lights are particularly suitable for airtight and spatially restricted installation scenarios in conjunction with Kaiser recessed housings.

To the product video.



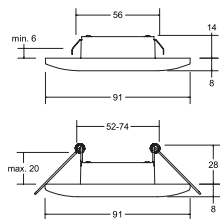

ADAPT LED recessed downlight set, switchable

NEW

Set including converter for 230 V mains voltage, switchable, dimensions of converter: L 52 x W 30 x H 23 mm

Illuminants: LED, color rendering: CRI > 80, power: 3 W, beam angle: 34°, material: Aluminum / Steel / Plastic, delivery: including recessed leaf springs for 56 mm cut-out with 14-mm installation depth and recessed leg springs for 52 - 74 mm cut-out (enclosed for quick replacement) with 28 mm installation depth.

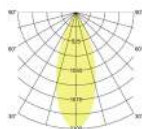

Item no.	Color	Luminous flux	Color temperature	Price €
38371033	NEW Chromium matte	440 lm	3000 K	58.20
38371073	NEW White	440 lm	3000 K	56.10
38371083	NEW Black	440 lm	3000 K	56.10
38371153	NEW Nickel matte	440 lm	3000 K	58.20
38371643	NEW Titanium matte	440 lm	3000 K	61.40



ADAPT is also best suited for installation in Kaiser device sockets 9064-02, HWD30 / 9464-50 and any deep device junction boxes with a screw spacing of 60 mm.

Front rings: Color selection (magnetic attachment)

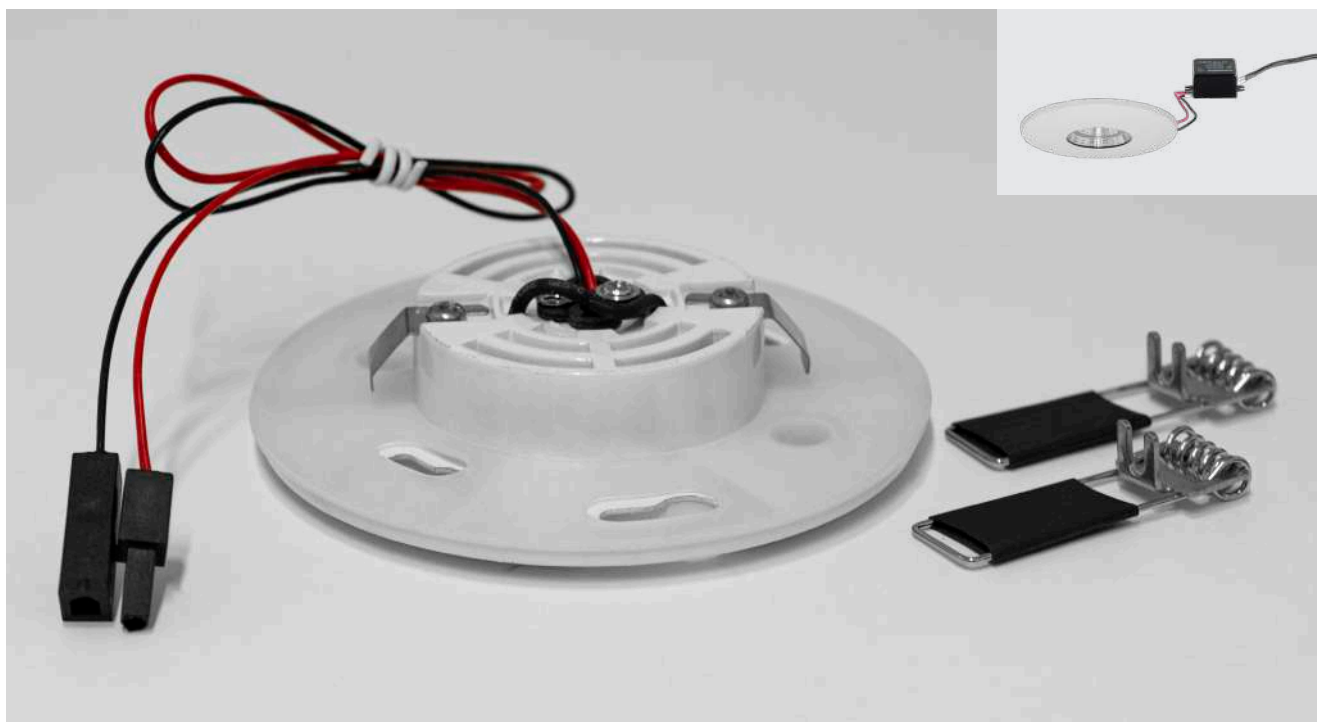



LED recessed downlight, IP44

Luminaires optimized for installation in furniture and wooden materials.

Illuminants: LED, color rendering: CRI > 85, power: 3.4 W, beam angle: 60°, material: Zinc die-cast / Plastic, delivery: including 2,000-mm connection cable

You will find corresponding 12 V power supplies and corresponding accessories suitable on page 531.

Item no.	Color	Luminous flux	Color temperature	Price €
12109023	Chromium	200 lm	2900 K	41.40
12109153	Nickel matte	200 lm	2900 K	41.40

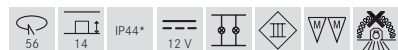

* IP44 when installed in closed ceilings



Surface-mounted housing for 12109...

Material: Steel, dimensions: D 66 x H 15 mm, screw spacing: 45 mm

Item no.	Color	Price €
81019020	Chromium	9.75
81019150	Nickel matte	9.75



LED recessed downlight, IP44

Luminaires optimized for installation in furniture and wooden materials.

Illuminants: LED, color rendering: CRI > 85, power: 3.4 W, beam angle: 60°, material: Zinc die-cast / Plastic, delivery: including 2,000-mm connection cable

You will find corresponding 12 V power supplies and corresponding accessories suitable on page 531.

Item no.	Color	Luminous flux	Color temperature	Price €
12110023	Chromium	200 lm	2900 K	44.30
12110153	Nickel matte	200 lm	2900 K	44.30



* IP44 when installed in closed ceilings

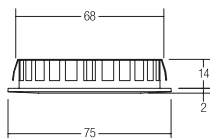

LED recessed downlight, IP44

Luminaires optimized for installation in furniture and wooden materials.

Illuminants: LED, color rendering: CRI > 85, power: 5 W, beam angle: 60°, material: Aluminum die-cast / Plastic, delivery: including 2,000-mm connection cable

You will find corresponding 12 V power supplies and corresponding accessories suitable on page 531.

Surface-mounted housing for 12127...

Material: Steel, dimensions: D 75 x H 15 mm, screw spacing: 56 mm

Item no.	Color	Luminous flux	Color temperature	Price €
12127023	Chromium	400 lm	2900 K	53.20
12127153	Nickel matte	400 lm	2900 K	53.20

Item no.	Color	Price €
81029020	Chromium	13.65
81029150	Nickel matte	13.65

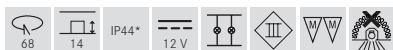

* IP44 when installed in closed ceilings

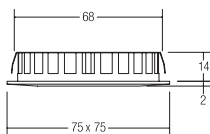

LED recessed downlight, IP44

Luminaires optimized for installation in furniture and wooden materials.

Illuminants: LED, color rendering: CRI > 85, power: 5 W, beam angle: 60°, material: Aluminum die-cast / Plastic, delivery: including 2,000-mm connection cable

You will find corresponding 12 V power supplies and corresponding accessories suitable on page 531.

Item no.	Color	Luminous flux	Color temperature	Price €
12128023	Chromium	400 lm	2900 K	59.00
12128153	Nickel matte	400 lm	2900 K	59.00

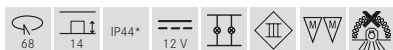

* IP44 when installed in closed ceilings

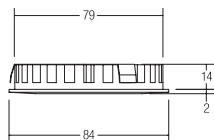

LED recessed downlight, IP44

Luminaires optimized for installation in furniture and wooden materials.

Illuminants: LED, color rendering: CRI > 85, power: 7.5 W, beam angle: 60°, material: Aluminum die-cast / Plastic, delivery: including 2,000-mm connection cable

You will find corresponding 12 V power supplies and corresponding accessories suitable on page 531.

Item no.	Color	Luminous flux	Color temperature	Price €
12129023	Chromium	500 lm	2900 K	59.90
12129153	Nickel matte	500 lm	2900 K	59.90

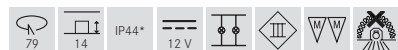

* IP44 when installed in closed ceilings

Surface-mounted housing for 12129...

Material: Steel, dimensions: D 84 x H 15 mm, screw spacing: 66 mm

Item no.	Color	Price €
81039020	Chromium	16.30
81039150	Nickel matte	16.30

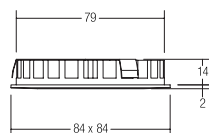

LED recessed downlight, IP44

Luminaires optimized for installation in furniture and wooden materials.

Illuminants: LED, color rendering: CRI > 85, power: 7.5 W, beam angle: 60°, material: Aluminum die-cast / Plastic, delivery: including 2,000-mm connection cable

You will find corresponding 12 V power supplies and corresponding accessories suitable on page 531.

Item no.	Color	Luminous flux	Color temperature	Price €
12130023	Chromium	500 lm	2900 K	65.70
12130153	Nickel matte	500 lm	2900 K	65.70

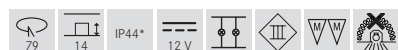

* IP44 when installed in closed ceilings

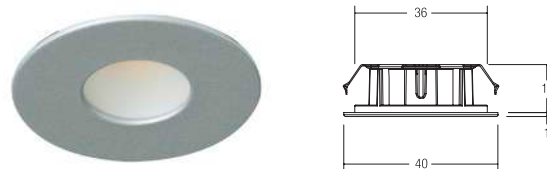

LED recessed downlight

Luminaires optimized for installation in furniture and wooden materials.

Illuminants: LED, color rendering: CRI > 81, power: 3.5 W, beam angle: 120°, material: Cast / Plastic, delivery: including 2,000-mm connection cable

You will find corresponding 12 V power supplies and corresponding accessories suitable on page 531.

LED recessed downlight

Luminaires optimized for installation in furniture and wooden materials.

Illuminants: LED, color rendering: CRI > 81, power: 2 W, beam angle: 45°, material: Aluminum / Plastic, delivery: including 2,000-mm connection cable

You will find corresponding 12 V power supplies and corresponding accessories suitable on page 531.

Item no.	Color	Luminous flux	Color temperature	Price €
12093263	Aluminum matte	275 lm	3200 K	59.20

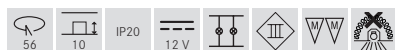

Item no.	Color	Luminous flux	Color temperature	Price €
12095263	Aluminum matte	175 lm	3200 K	37.40

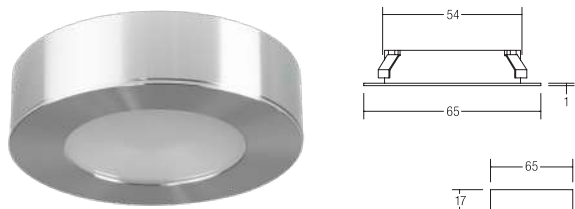
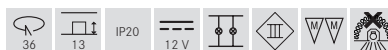

LED recessed downlight including optional surface-mounted housing

Luminaires optimized for installation in/on furniture and wooden materials.

This luminaire can be used as recessed (hole cut-out: 54 mm, installation depth: 16 mm) as well as surface-mounted luminaire (screw spacing: 42 mm). Illuminants: LED, model: Plug&Play, color rendering: CRI > 80, power: 3.3 W, beam angle: 92°, material: Aluminum / Plastic

You will find the corresponding 350-mA converters from page 516 onwards.

BB17 LED recessed downlight set, switchable

Set of luminaires optimized for installation in furniture and wooden materials, including converter for 230-V mains voltage, switchable, dimensions of converter: L 68 x W 35 x H 21 mm, Illuminants: LED, color rendering: CRI > 80, power: 3 W, beam angle: 60°, material: Steel / Plastic, delivery: including 900 mm connection line between the converter and the luminaire

Item no.	Color	Luminous flux	Color temperature	Price €
12078073	White	195 lm	3000 K	59.40
12078253	Aluminum matte	195 lm	3000 K	60.80



Item no.	Color	Luminous flux	Color temperature	Price €
38370073	White	260 lm	3000 K	31.00
38370153	Nickel matte	260 lm	3000 K	33.10



MM sign of the luminaire included in the set.

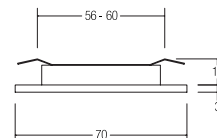
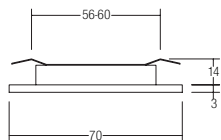

LED recessed downlight

Luminaires optimized for installation in furniture and wooden materials. Illuminants: LED, color rendering: CRI > 81, power: 2 W, beam angle: 45°, material: Cast / Plastic, delivery: including 2,000-mm connection cable. Installation diameters between 56 and 60 mm are possible due to the leaf springs used.

You will find corresponding 12 V power supplies and corresponding accessories suitable on page 531.

Item no.	Color	Luminous flux	Color temperature	Price €
12027153	Aluminum matte	175 lm	3200 K	59.90



LED recessed downlight set

Set of luminaires optimized for installation in furniture and wooden materials with 3 x luminaires each with 2,000-mm connection cable, 1 x distributor and 1 x power supply for 230-V mains voltage, switchable, dimensions of power supply: L 105 x W 49 x H 18 mm. Installation diameters between 56 and 60 mm are possible due to the leaf springs used.

Illuminants: LED, color rendering: CRI > 81, power: 3 W, beam angle: 45°, Luminous flux: 3 x 175 lm, material: Cast / Plastic

Item no.	Color	Luminous flux	Color temperature	Price €
12171153	Aluminum matte	525 lm	3200 K	239.90



MM-sign of the luminaire included in the set.

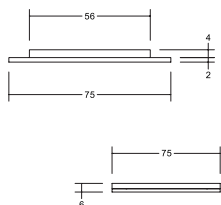

X-FLAT LED recessed/surface-mounted downlight

Luminaires optimized for installation in furniture and wooden materials. Illuminants: LED, color rendering: CRI > 81, power: 2.6 W, beam angle: 120°, material: Aluminum / Steel / Plastic, delivery: including 2,000-mm connection cable

You will find corresponding 12 V power supplies and corresponding accessories suitable on page 531.

Item no.	Color	Luminous flux	Color temperature	Price €
12164023	Chromium shield	185 lm	3000 K	45.40
12164073	White shield	185 lm	3000 K	45.40
12164083	Black shield	185 lm	3000 K	45.40
12164153	Nickel matte shield	185 lm	3000 K	45.40



This luminaire can be used as recessed (hole cut-out: 56 mm, installation depth: **3.5 mm**, installation height: 2.2 mm) as well as surface-mounted luminaire (total height: **5.9 mm**) using the provided surface-mounted housing.

Outer edge nickel matte, magnetically fixed shield in color shade according to item table.

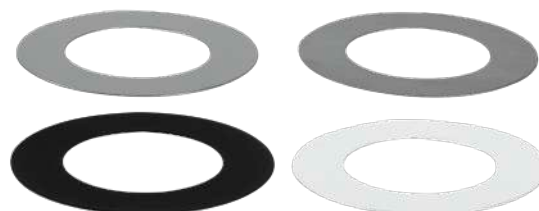

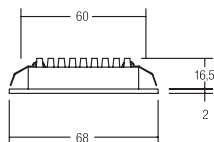

LED recessed downlight

Luminaires optimized for installation in furniture and wooden materials.

Illuminants: LED, model: Plug&Play, color rendering: CRI > 80, power: 3 W, beam angle: 120°, material: Aluminum / Plastic

You will find the corresponding 350-mA converters from page 516 onwards.

Item no.	Color	Luminous flux	Color temperature	Price €
12090073	White	300 lm	3000 K	39.00
12090083	Black	300 lm	3000 K	39.00
12090623	Aluminum glossy	300 lm	3000 K	39.00

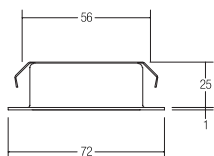

Recessed downlight, G4

Luminaires optimized for installation in furniture and wooden materials.

Illuminants: For LV halogen lamp, model: G4, power: maximum 20 W, material: Steel / Glass, delivery: including AMP plug

You will find the corresponding low-voltage AMP accessory on page 555.

Item no.	Color	Price €
2358.00	Brass glossy	12.00
2358.02	Chromium	11.40
2358.07	White	9.10
2358.15	Nickel matte	12.00



1

Interior lighting

02 Ceiling surface-mounted luminaires.

Suitable ceiling lighting for every construction material.

Downlights (rigid)
Spotlights (swiveling)
Surface luminaires

Page 162
Page 178
Page 180

Ring luminaires / BIRO Circle
Shade luminaires
Panel luminaires

Page 182
Page 184
Page 192



State Academy of Music, Stuttgart



SUNNY.

One luminaire, three adjustable Color temperatures.

Sunny wins you over with its "direct and indirect" virtues of simple bayonet mounting, flexible Color temperature adjustment and with an additionally deliverable color ring for the indirect component, which can color-mark building areas. The color temperature can be adjusted on site to 3000, 4000 or 6000 Kelvin. These lights are therefore suitable for numerous applications ranging from private homes to public buildings.

To the product
video.



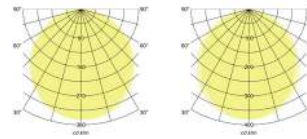
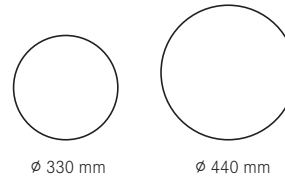

SUNNY LED ceiling surface-mounted downlight, dimmable phase section

NEW

Direct and indirect light emission, dimmable phase section.

Illuminants: LED, color rendering: CRI > 80, material: Aluminum / Steel / Plastic, delivery: including converter for connection with 230 V mains voltage, dimmable phase section and changeover switch for setting the color temperature to 3000 K, 4000 K or 6000 K.

Optional accessory: Color ring set for the indirect component in the red, blue and amber colors as well as a 1,500 mm pendant set.

Sizes: Two sizes allow a flexible integration of different lumen ranges from 2,700 lm to 3,750 lm.



Item no.	Color	Performance	Luminous flux	Color temperature	Installation height	Diameter	Price €
12208073	NEW White	30 W	2,700 lm	3000 K / 4000 K / 6000 K	45 mm	330 mm	150.60
12209073	NEW White	40 W	3,750 lm	3000 K / 4000 K / 6000 K	50 mm	440 mm	200.40

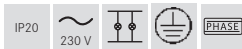

These items are subject to discount group 2.



Additional **color ring sets** for indirect ambient lighting and additional **pendant set**.



Installation: Fast, tool-free mounting thanks to separate mounting plate and modular system design. The luminaire housing is screwed on without tools by means of bayonet fixing.



Item no.	Description	Price €
81020806	NEW Color ring set for 12208 red	10.50
81020808	NEW Color ring set for 12208 blue	10.50
81020809	NEW Color ring set for 12208 amber	10.50
81020906	NEW Color ring set for 12209 red	14.80
81020908	NEW Color ring set for 12209 blue	14.80
81020909	NEW Color ring set for 12209 amber	14.80
81018070	NEW Pendant set for SUNNY LED surface-mounted downlight 12208... / 12209... white, round, pendant length 1,500 mm	31.70

These items are subject to discount group 2.



Private house, Kleinwallestadt



reddot award 2017
winner lighting design

QUBIC LED surface-mounted downlight

LED ceiling surface-mounted downlight with 9.5 W / 930 lm direct and 1.5 W / 150 lm indirect light component.

Illuminants: LED, color rendering: CRI > 90, power: 11 W, beam angle: 60°, material: Aluminum / plastic, delivery: including converter for connection with 230 V mains voltage, switchable

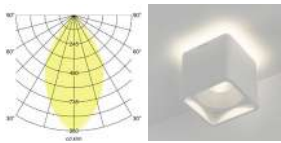

Item no.	Color	Luminous flux	Color temperature	Price €
12040173	Structural white	1,080 lm	3000 K	230.00

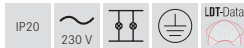

Design: Lounge Design (Alexander Grimm and Ronny Eysser)
Idea: Lichtraum Ruschmann Stein GmbH (Michael Ruschmann)



reddot award 2019
winner

TUBIC LED surface-mounted downlight

LED ceiling surface-mounted downlight with 9.5 W / 900 lm direct and 1.5 W / 150 lm indirect light component.

Illuminants: LED, color rendering: CRI > 90, power: 11 W, beam angle: 60°, material: Aluminum / plastic, delivery: including converter for connection with 230 V mains voltage, switchable

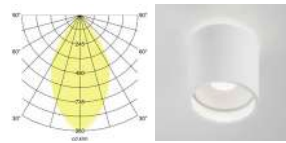

Item no.	Color	Luminous flux	Color temperature	Price €
12042173	Structural white	1,050 lm	3000 K	218.00

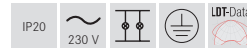

Design: Alexander Grimm (Lounge Design)
Idea: Michael Ruschmann (Lichtraum Ruschmann Stein GmbH)

QUBIC product family



QUBIC LED recessed ceiling luminaire, with indirect component
Item no. 12227173
See page 14



QUBIC LED ceiling-mounted recessed spotlight
Item no. 13127173
See page 39



QUBIC LED wall surface-mounted luminaire, with indirect component
Item no. 10040173
See page 224

TUBIC product family



TUBIC LED recessed ceiling luminaire, with indirect component
Item no. 12226173
See page 14



TUBIC LED ceiling-mounted recessed spotlight
Item no. 13126173
See page 39



TUBIC LED wall surface-mounted luminaire, with indirect component
Item no. 10042173
See page 224



Free Church Congregation, Wesel-Lackhausen

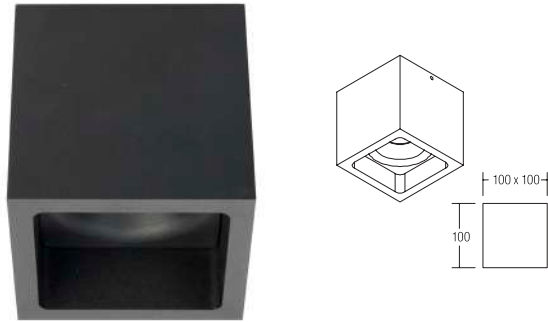

LED surface-mounted downlight, switchable

Illuminants: LED, color rendering: CRI > 80, power: 15 W, beam angle: 38°, material: Aluminum / Glass, delivery: including converter for connection with 230 V mains voltage, switchable

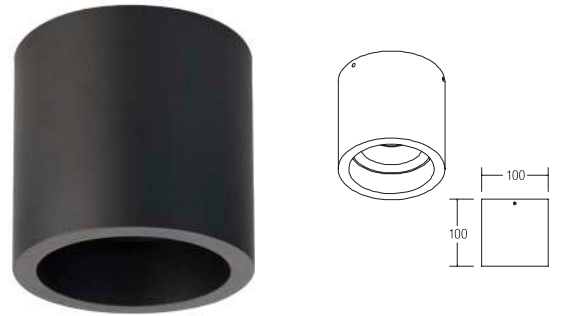

LED surface-mounted downlight, switchable

Illuminants: LED, color rendering: CRI > 80, power: 15 W, beam angle: 38°, material: Aluminum / Glass, delivery: including converter for connection with 230 V mains voltage, switchable

Item no.	Color	Luminous flux	Color temperature	Price €
12075183	Structural black	1,125 lm	3000 K	195.00

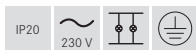

Item no.	Color	Luminous flux	Color temperature	Price €
12074183	Structural black	1,125 lm	3000 K	190.00

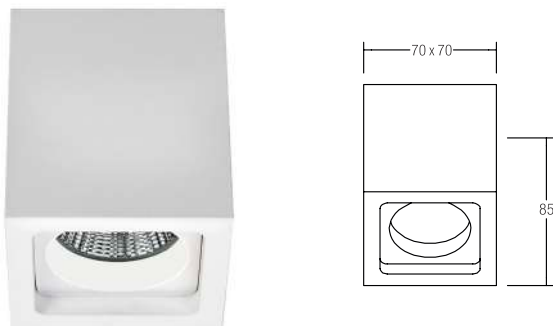

LED surface mounted downlight, IP54, switchable

Illuminants: LED, color rendering: CRI > 80, power: 7 W, beam angle: 30°, material: Aluminum / Glass, delivery: including converter for connection with 230 V mains voltage, switchable

Item no.	Color	Luminous flux	Color temperature	Price €
12076173	Structural white	450 lm	3000 K	178.40





IMPLEMENT.

Planning, installation and retrofitting without any worries.

With their round or square design, the luminaires of the Implement series blend into modern rooms and act as an eye catcher. For optimum lighting results, these luminaires offer glare control and design-optimized light emission - with single or double-flame housing.

To the product
video.



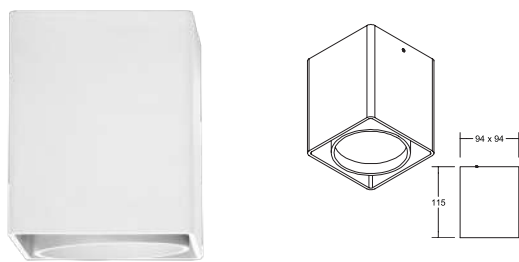

IMPLEMENT LED surface-mounted downlight, dimmable phase section

Luminaire including converter for 230 V mains voltage, dimmable phase section

Illuminants: LED, color rendering: CRI > 90, power: 8.9 W, beam angle: 37°, material: Aluminum / plastic, delivery: including converter for connection with 230 V mains voltage, dimmable phase section

You will find the recessed version on page 10.

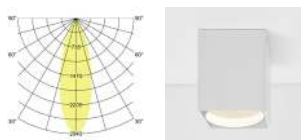

Item no.	Color	Luminous flux	Color temperature	Price €
12392173	Structural white	730 lm	3000 K	147.00

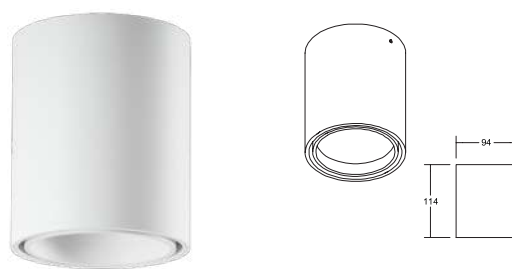

IMPLEMENT LED surface-mounted downlight, dimmable phase section

NEW

Luminaire including converter for 230 V mains voltage, dimmable phase section

Illuminants: LED, color rendering: CRI > 90, power: 8.9 W, beam angle: 37°, material: Aluminum / plastic, delivery: including converter for connection with 230 V mains voltage, dimmable phase section

You will find the recessed version on page 10.

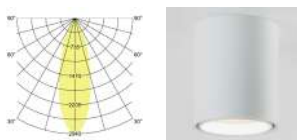

Item no.	Color	Luminous flux	Color temperature	Price €
12394173	NEW Structural white	730 lm	3000 K	146.10

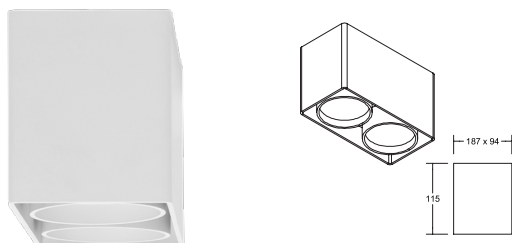
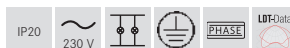

IMPLEMENT LED surface-mounted downlight, 2-fold, dimmable phase section

Luminaire including converter for 230 V mains voltage, dimmable phase section

Illuminants: LED, color rendering: CRI > 90, power: 2 x 8.9 W, beam angle: 37°, luminous flux: 2 x 730 lm, material: Aluminum / plastic, delivery: including converter for connection with 230 V mains voltage, dimmable phase section

You will find the recessed version on page 10.

Item no.	Color	Luminous flux	Color temperature	Price €
12393173	Structural white	1,460 lm	3000 K	306.00

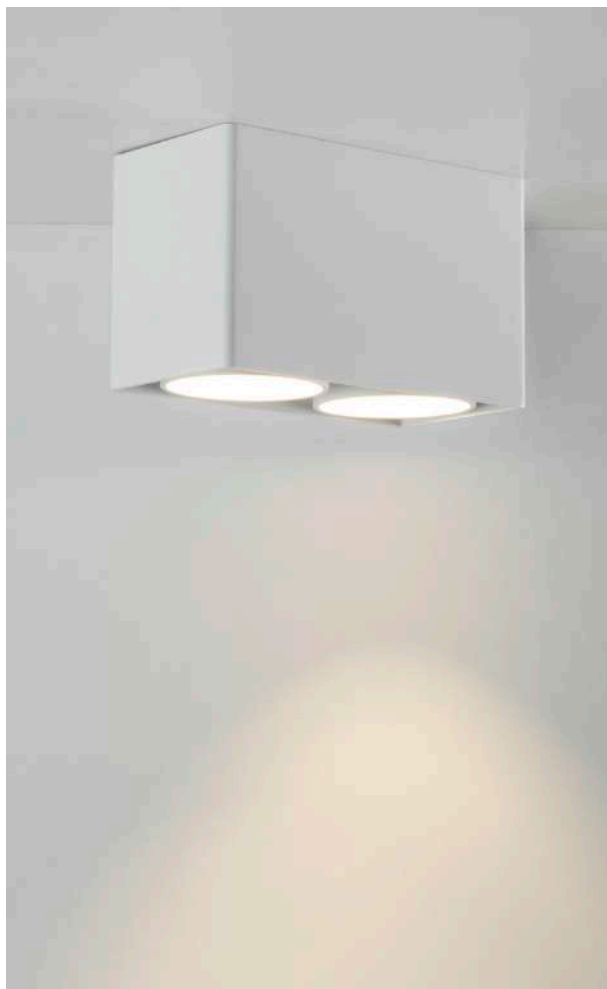

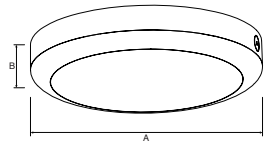

LED ceiling-mounted & wall surface-mounted luminaires, IP65 NEW

Illuminants: LED, beam angle: 110°, color rendering: CRI > 80, color temperature: 3000 K, material: Plastic, impact resistance: IK08, including converter for connection with 230 V mains voltage, switchable

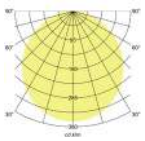

Item no.	Color	Performance	Luminous flux	Height (B)	Diameter (A)	Price in €
32040073	NEW White	15 W	1,270 lm	60 mm	300 mm	88.50

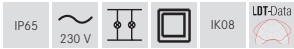

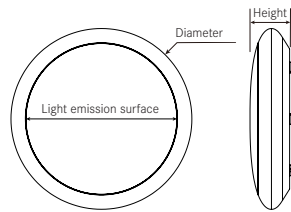

LED ceiling-mounted luminaire, IP65

NEW

Illuminants: LED, beam angle: 120°, color rendering: CRI > 80, color temperature: 3000 K, material: Plastic, impact resistance: IK10, including converter for connection with 230 V mains voltage, switchable

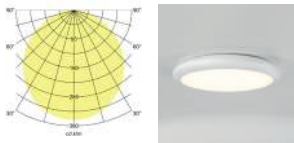

Item no.	Color	Performance	Luminous flux	Height	Diameter	Light emission surface	Price in €
32034073	NEW White	18 W	1,603 lm	70 mm	320 mm	250 mm	98.00
32035073	NEW White	25 W	2,409 lm	85 mm	420 mm	358 mm	136.00
32036073	NEW White	30 W	2,752 lm	85 mm	520 mm	440 mm	184.00





DEVELOPED BY
INSTA

FEATURED BY
GIRA & JUNG

MEMBER
BRUMBERG

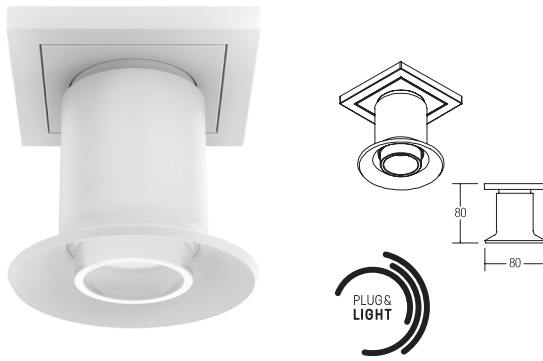

Plug & Light GRAMMO LED ceiling-mounted luminaire

Attention: only to be used in combination with the Plug & Light system of GIRA and JUNG. Dimming function can be called via corresponding components from GIRA or JUNG.

Illuminants: LED, color rendering: CRI > 85, power: 8 W, beam angle: 35°, material: Aluminum / Glass

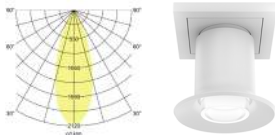

Item no.	Color	Luminous flux	Color temperature	Price €
12703173	Structural white	400 lm	3000 K	251.40

This item is subject to discount group 2.
 Design: Alexander Grimm (Lounge Design)

Deliverable accessory: Bracket with magnet for Plug & Light
 Item no. 81077000, price €: 10.50 (RG2)

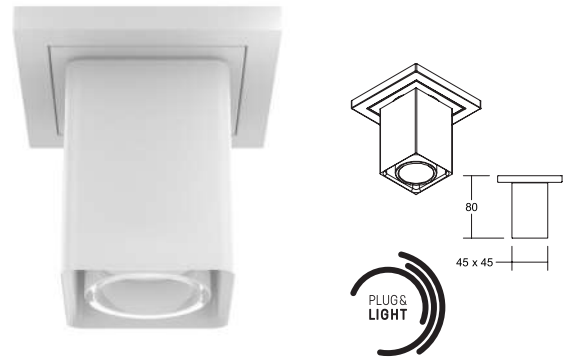

Plug & Light MINIQ LED ceiling-mounted luminaire

Attention: only to be used in combination with the Plug & Light system of GIRA and JUNG. Dimming function can be called via corresponding components from GIRA or JUNG.

Illuminants: LED, color rendering: CRI > 85, power: 8 W, beam angle: 35°, material: Aluminum / Glass

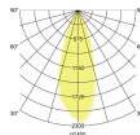

Item no.	Color	Luminous flux	Color temperature	Price €
12701173	Structural white	400 lm	3000 K	217.30

This item is subject to discount group 2.
 Design: Alexander Grimm (Lounge Design)

Deliverable accessory: Bracket with magnet for Plug & Light
 Item no. 81077000, price €: 10.50 (RG2)



Plug & Light BOWL LED ceiling-mounted luminaire

Attention: only to be used in combination with the Plug & Light system of GIRA and JUNG. Dimming function can be called via corresponding components from GIRA or JUNG.

Illuminants: LED, color rendering: CRI > 85, power: 7 W, beam angle: 35°, material: Aluminum / Glass

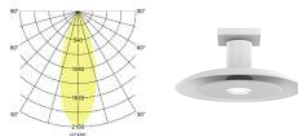

Item no.	Color	Luminous flux	Color temperature	Price €
12707173	Structural white	480 lm	3000 K	295.30

This item is subject to discount group 2.
 Design: Alexander Grimm (Lounge Design)

Deliverable accessory: Bracket with magnet for Plug & Light
 Item no. 81077000, price €: 10.50 (RG2)



Surface-mounted luminaire, IP43, switchable

Ceiling or wall surface-mounted luminaires designed as glass luminaires. In timeless, round design, available in various illuminant and power versions. Switchable LED models, color rendering: CRI > 80, mouth-blown opal glass with glass attachment via bayonet catch.

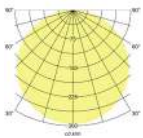

Item no.	Model	Dimensions	Performance	Color temperature	Luminous flux	Price €
58272003	LED	D 250 x H 100 mm	11 W	3000 K	1,020 lm	279.90
58274003	LED	D 300 x H 100 mm	15 W	3000 K	1,460 lm	319.90
58276003	LED	D 350 x H 120 mm	25 W	3000 K	2,110 lm	439.90
58278003	LED	D 450 x H 130 mm	29 W	3000 K	2,660 lm	579.90
58280003	LED	D 550 x H 150 mm	29 W	3000 K	2,690 lm	699.90
58271000	E27	D 250 x H 100 mm	1 x maximum 60 W	-	-	89.90
58273000	E27	D 300 x H 100 mm	2 x maximum 60 W	-	-	119.90
58275000	E27	D 350 x H 120 mm	3 x maximum 60 W	-	-	179.90
58277000	E27	D 450 x H 130 mm	3 x maximum 60 W	-	-	249.90
58279000	E27	D 550 x H 150 mm	3 x maximum 60 W	-	-	389.90

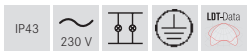

These items are subject to discount group 2.





Surface-mounted luminaire, IP43, switchable

Ceiling or wall surface-mounted luminaires designed as glass luminaires. In timeless, cylindrical design, available in various illuminant and power versions. Switchable LED models, color rendering: CRI > 80, mouth-blown opal glass with glass attachment via bayonet catch.

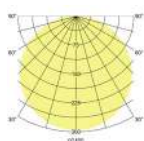

Item no.	Model	Dimensions	Performance	Color temperature	Luminous flux	Price €
58292003	LED	D 260 x H 65 mm	11 W	3000 K	940 lm	329.90
58294003	LED	D 310 x H 70 mm	15 W	3000 K	1,330 lm	369.90
58296003	LED	D 400 x H 90 mm	25 W	3000 K	1,950 lm	499.90
58298003	LED	D 450 x H 110 mm	29 W	3000 K	2,620 lm	689.90
58291000	E27	D 260 x H 65 mm	1 x maximum 60 W	-		139.90
58293000	E27	D 310 x H 70 mm	2 x maximum 60 W	-		179.90
58295000	E27	D 400 x H 90 mm	3 x maximum 60 W	-		249.90
58297000	E27	D 450 x H 110 mm	3 x maximum 60 W	-		389.90

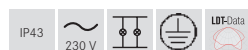

These items are subject to discount group 2.



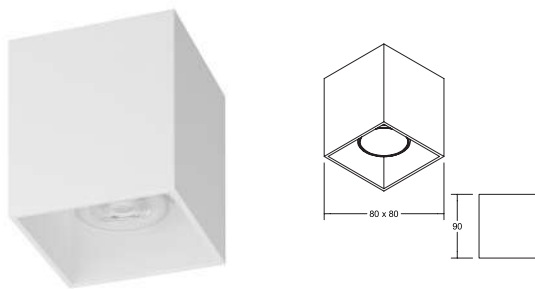

TURN surface-mounted module, for GU10 lamp

NEW

Module for 1 x LED retrofit lamp.

Power: maximum 7.5 W, with GU10 holder, material: Aluminum, delivery: without LED illuminant

Item no.	Color	Price €
45131170	NEW Structural white	52.00
45131180	NEW Structural black	52.00

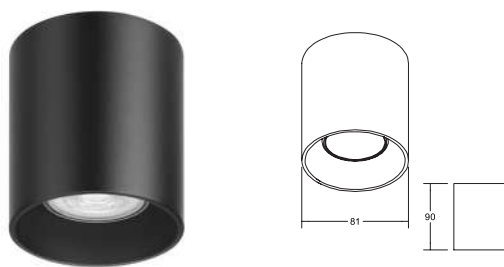
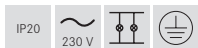

TURN surface-mounted module, for GU10 lamp

NEW

Module for 1 x LED retrofit lamp.

Power: maximum 7.5 W, with GU10 holder, material: Aluminum, delivery: without LED illuminant

Item no.	Color	Price €
45130170	NEW Structural white	46.20
45130180	NEW Structural black	46.20

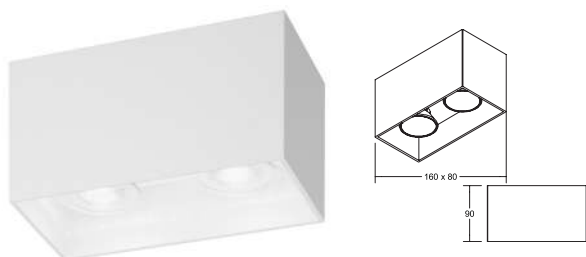

TURN surface-mounted module, for GU10 lamps

NEW

Module for 2 x LED retrofit lamps.

Power: maximum 2 x 7.5 W, with GU10 holders, material: Aluminum, delivery: without LED illuminant

Item no.	Color	Price €
45135170	NEW Structural white	76.40
45135180	NEW Structural black	76.40





Module system M 1. Individuality redefined.

In four steps to their individual ceiling-mounted luminaire. Choose between a black or a white housing or combine black and white. The luminaire can be assembled in round or square and with one to two lamps.

Discover the surface-mounted variants on page 104.

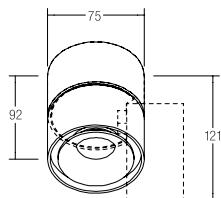

CIRCLE LED surface-mounted spotlight, with circumferential light joint, switchable

Illuminants: LED, color rendering: CRI > 85, power: 6.2 W, beam angle: 34°, material: Aluminum / Glass, delivery: including converter for connection with 230 V mains voltage, switchable

Recessed variant: see page 12.

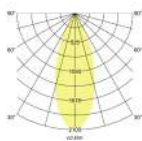

Item no.	Color	Luminous flux	Color temperature	Price €
12062173	Structural white	410 lm	3000 K	155.00

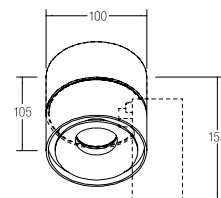

CIRCLE LED surface-mounted spotlight, with circumferential light joint, switchable

Illuminants: LED, color rendering: CRI > 85, power: 9.8 W, beam angle: 34°, material: Aluminum / Glass, delivery: including converter for connection with 230 V mains voltage, switchable

Recessed variant: see page 12.

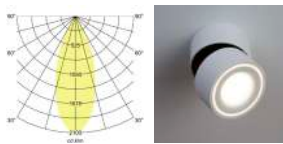

Item no.	Color	Luminous flux	Color temperature	Price €
12061073	Structural white	675 lm	3000 K	225.00

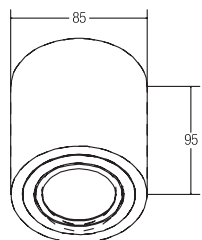

LED surface-mounted spotlight, switchable

Illuminants: LED, color rendering: CRI > 80, power: 6 W, beam angle: 38°, material: Aluminum / Glass, delivery: including converter for connection with 230 V mains voltage, switchable

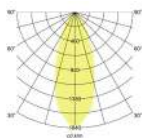

Item no.	Color	Luminous flux	Color temperature	Price €
12063173	Structural white	640 lm	3000 K	125.00

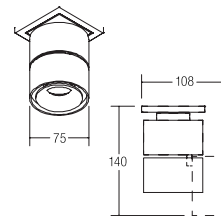

CIRCLE Plug & Light LED ceiling surface-mounted spotlight

Attention: only to be used in combination with the Plug & Light system of GIRA and JUNG. Dimming function can be called via corresponding components from GIRA or JUNG.

Illuminants: LED, color rendering: CRI > 85, power: 6.2 W, beam angle: 34°, material: Aluminum

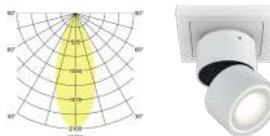

Item no.	Color	Luminous flux	Color temperature	Price €
12708173	Structural white	410 lm	3000 K	217.30



This item is subject to discount group 2. Design: Alexander Grimm (Lounge Design)

Deliverable accessory: Bracket with magnet for Plug & Light
Item no. 81077000, price € :10.50 (RG2)

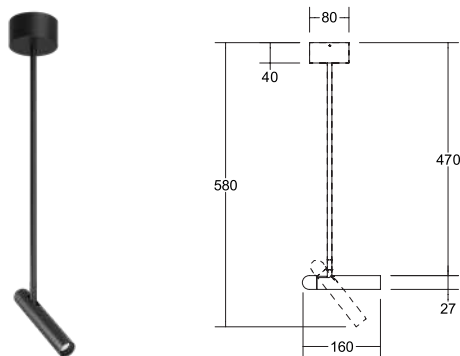

CUBA LED surface-mounted spotlight, rotatable and swiveling, switchable

NEW

Illuminants: LED, color rendering: CRI > 90, power: 4.5 W, beam angle: 38°, material: Aluminum, delivery: including converter for connection with 230 V mains voltage, switchable

Item no.	Color	Luminous flux	Color temperature	Price €
12307173	NEW Structural white	250 lm	3000 K	151.30
12307183	NEW Structural black	250 lm	3000 K	151.30



CUBA product family



CUBA LED recessed spotlight
See page 78



CUBA LED wall surface-mounted spotlight
See page 237



CUBA LED recessed spotlight
See page 79



CUBA LED pendant luminaire
See page 198

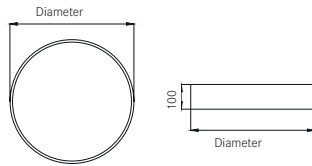

BIRO CIRCLE pendant surface luminaire
See page 204

BIRO CIRCLE surface-mounted luminaire, direct NEW

Illuminants: LED, input voltage: 220 - 240 V AC, 50 - 60 Hz, color rendering: CRI > 80, beam angle: 120°, cover: PMMA, opal, material: Aluminum / Steel / Plastic

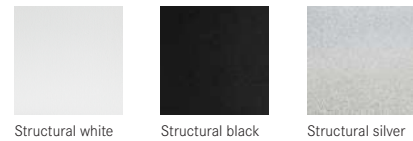
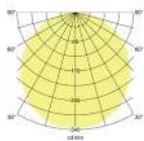

Diameter	Item no. structural white	Item no. structural black	Item no. structural silver	Color temperature	Cover	Controlling	Luminous flux	System efficiency	System power	Price in €
450 mm	13685173	13685183	13685163	3000 K	Opal	Switchable	2,450 lm	98 lm/W	25 W	329.90
450 mm	13685174	13685184	13685164	4000 K	Opal	Switchable	2,550 lm	102 lm/W	25 W	329.90
450 mm	13695173	13695183	13695163	3000 K	Opal	DALI	2,450 lm	98 lm/W	25 W	399.90
450 mm	13695174	13695184	13695164	4000 K	Opal	DALI	2,550 lm	102 lm/W	25 W	399.90
600 mm	13680173	13680183	13680163	3000 K	Opal	Switchable	5,186 lm	103 lm/W	50 W	499.90
600 mm	13680174	13680184	13680164	4000 K	Opal	Switchable	5,400 lm	108 lm/W	50 W	499.90
600 mm	13690173	13690183	13690163	3000 K	Opal	DALI	5,186 lm	103 lm/W	50 W	579.90
600 mm	13690174	13690184	13690164	4000 K	Opal	DALI	5,400 lm	108 lm/W	50 W	579.90
750 mm	13681173	13681183	13681163	3000 K	Opal	Switchable	7,328 lm	104 lm/W	70 W	599.90
750 mm	13681174	13681184	13681164	4000 K	Opal	Switchable	7,630 lm	109 lm/W	70 W	599.90
750 mm	13691173	13691183	13691163	3000 K	Opal	DALI	7,328 lm	104 lm/W	70 W	699.90
750 mm	13691174	13691184	13691164	4000 K	Opal	DALI	7,630 lm	109 lm/W	70 W	699.90
1,000 mm	13682173	13682183	13682163	3000 K	Opal	Switchable	13,925 lm	111 lm/W	125 W	1,039.00
1,000 mm	13682174	13682184	13682164	4000 K	Opal	Switchable	14,500 lm	116 lm/W	125 W	1,039.00
1,000 mm	13692173	13692183	13692163	3000 K	Opal	DALI	13,925 lm	111 lm/W	125 W	1,189.90
1,000 mm	13692174	13692184	13692164	4000 K	Opal	DALI	14,500 lm	116 lm/W	125 W	1,189.90
1,200 mm	13683173	13683183	13683163	3000 K	Opal	Switchable	19,650 lm	112 lm/W	175 W	1,350.00
1,200 mm	13683174	13683184	13683164	4000 K	Opal	Switchable	20,475 lm	117 lm/W	175 W	1,350.00
1,200 mm	13693173	13693183	13693163	3000 K	Opal	DALI	19,650 lm	112 lm/W	175 W	1,459.00
1,200 mm	13693174	13693184	13693164	4000 K	Opal	DALI	20,475 lm	117 lm/W	175 W	1,459.00
1,500 mm	13684173	13684183	13684163	3000 K	Opal	Switchable	28,550 lm	118 lm/W	240 W	1,789.00
1,500 mm	13684174	13684184	13684164	4000 K	Opal	Switchable	29,760 lm	124 lm/W	240 W	1,789.00
1,500 mm	13694173	13694183	13694163	3000 K	Opal	DALI	28,550 lm	118 lm/W	240 W	1,979.00
1,500 mm	13694174	13694184	13694164	4000 K	Opal	DALI	29,760 lm	124 lm/W	240 W	1,979.00



These items are subject to discount group 2.

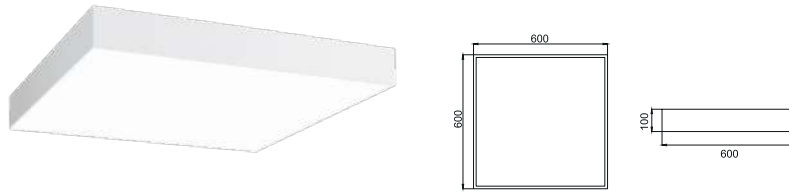

BIRO SQUARE pendant surface luminaire
See page 205

BIRO SQUARE surface-mounted surface luminaire 600 x 600 mm, direct

NEW

Illuminants: LED, input voltage: 220 - 240 V AC, 50 - 60 Hz, color rendering: CRI > 80, beam angle: 114°, power: 44 W, cover: PMMA, opal, material: Aluminum / Steel / Plastic

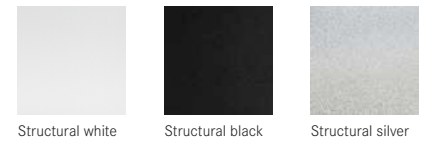
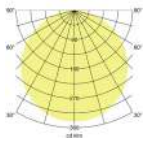

Item no. structural white	Item no. structural black	Item no. structural silver	Color temperature	Cover	Controlling	Luminous flux	System efficiency	Price in €
13700173	13700183	13700163	3000 K	Opal	Switchable	5,240 lm	119 lm/W	239.90
13700174	13700184	13700164	4000 K	Opal	Switchable	5,456 lm	124 lm/W	239.90
13710173	13710183	13710163	3000 K	Opal	DALI	5,240 lm	119 lm/W	299.90
13710174	13710184	13710164	4000 K	Opal	DALI	5,456 lm	124 lm/W	299.90



Also available on request in dimensions 300 x 300 mm (power: 12 W).
These items are subject to discount group 2.

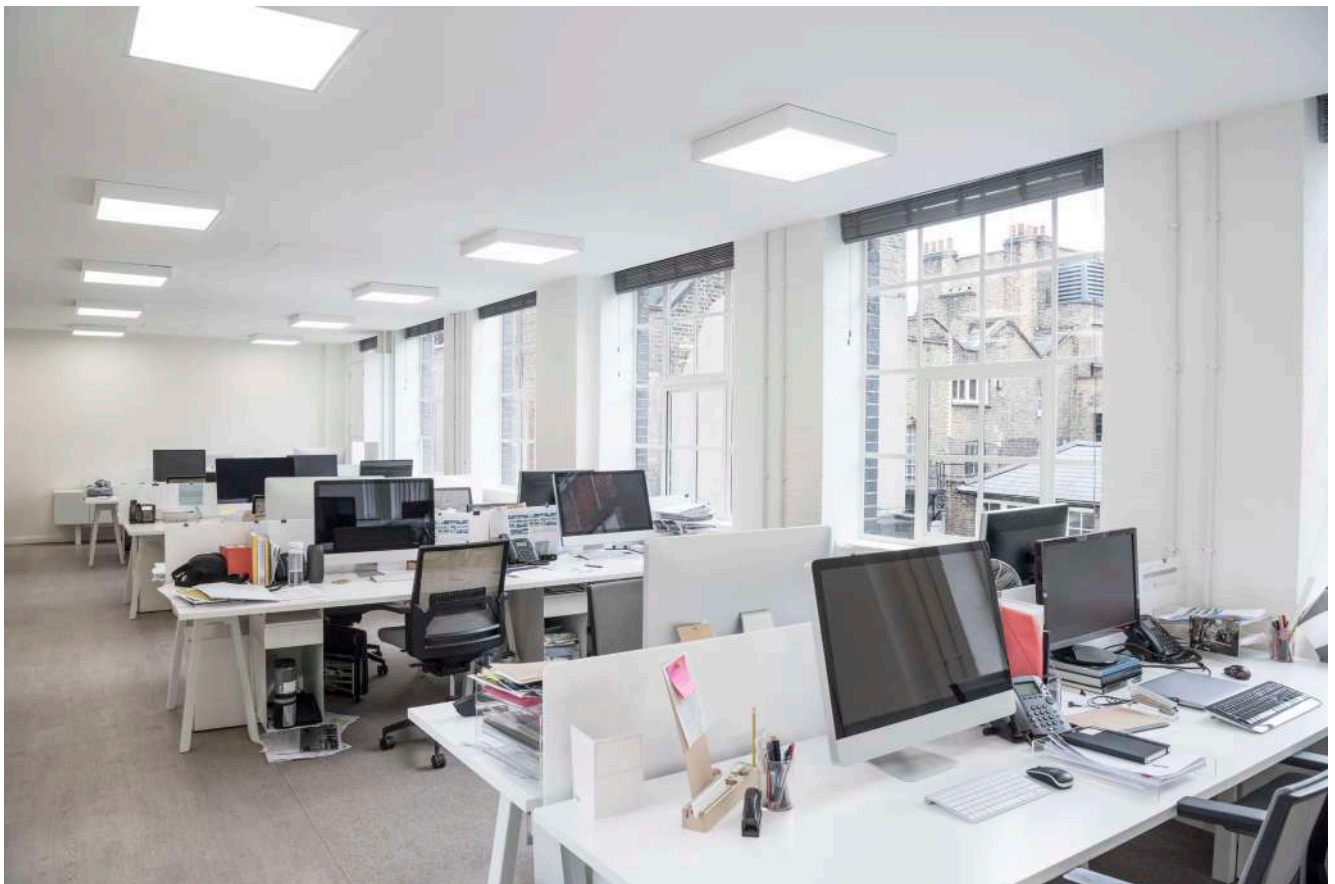



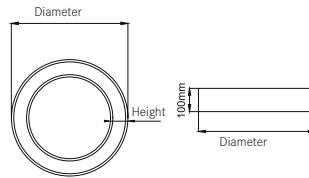

BIRO CIRCLE pendant ring luminaire, direct
See page 206

BIRO CIRCLE surface-mounted ring luminaire, direct

NEW

Illuminants: LED, input voltage: 220 - 240 V AC, 50 - 60 Hz, color rendering: CRI > 80, beam angle: 108°, cover: PMMA, opal, material: Aluminum / Steel / Plastic

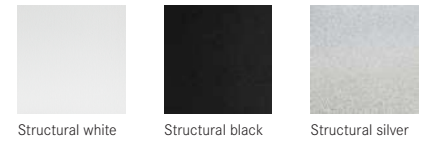
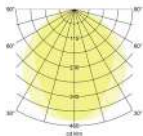

Diameter	Item no. structural white	Item no. structural black	Item no. structural silver	Color temperature	Cover	Controlling	Luminous flux	System efficiency	System power	Price in €
450 mm	13665173	13665183	13665163	3000 K	Opal	Switchable	1,250 lm	100 lm/W	12.5 W	389.90
450 mm	13665174	13665184	13665164	4000 K	Opal	Switchable	1,300 lm	104 lm/W	12.5 W	389.90
450 mm	13675173	13675183	13675163	3000 K	Opal	DALI	1,250 lm	100 lm/W	12.5 W	489.90
450 mm	13675174	13675184	13675164	4000 K	Opal	DALI	1,300 lm	104 lm/W	12.5 W	489.90
600 mm	13660173	13660183	13660163	3000 K	Opal	Switchable	2,545 lm	101 lm/W	25 W	519.90
600 mm	13660174	13660184	13660164	4000 K	Opal	Switchable	2,650 lm	106 lm/W	25 W	519.90
600 mm	13670173	13670183	13670163	3000 K	Opal	DALI	2,545 lm	101 lm/W	25 W	619.90
600 mm	13670174	13670184	13670164	4000 K	Opal	DALI	2,650 lm	106 lm/W	25 W	619.90
750 mm	13661173	13661183	13661163	3000 K	Opal	Switchable	4,150 lm	103 lm/W	40 W	599.90
750 mm	13661174	13661184	13661164	4000 K	Opal	Switchable	4,320 lm	108 lm/W	40 W	599.90
750 mm	13671173	13671183	13671163	3000 K	Opal	DALI	4,150 lm	103 lm/W	40 W	699.90
750 mm	13671174	13671184	13671164	4000 K	Opal	DALI	4,320 lm	108 lm/W	40 W	699.90
1,000 mm	13662173	13662183	13662163	3000 K	Opal	Switchable	6,603 lm	105 lm/W	62.5 W	789.90
1,000 mm	13662174	13662184	13662164	4000 K	Opal	Switchable	6,875 lm	110 lm/W	62.5 W	789.90
1,000 mm	13672173	13672183	13672163	3000 K	Opal	DALI	6,603 lm	105 lm/W	62.5 W	889.90
1,000 mm	13672174	13672184	13672164	4000 K	Opal	DALI	6,875 lm	110 lm/W	62.5 W	889.90
1,200 mm	13663173	13663183	13663163	3000 K	Opal	Switchable	8,067 lm	107 lm/W	75 W	919.90
1,200 mm	13663174	13663184	13663164	4000 K	Opal	Switchable	8,400 lm	112 lm/W	75 W	919.90
1,200 mm	13673173	13673183	13673163	3000 K	Opal	DALI	8,067 lm	107 lm/W	75 W	1,019.90
1,200 mm	13673174	13673184	13673164	4000 K	Opal	DALI	8,400 lm	112 lm/W	75 W	1,019.90
1,500 mm	13664173	13664183	13664163	3000 K	Opal	Switchable	12,320 lm	109 lm/W	112.5 W	1,119.90
1,500 mm	13664174	13664184	13664164	4000 K	Opal	Switchable	12,828 lm	113 lm/W	112.5 W	1,119.90
1,500 mm	13674173	13674183	13674163	3000 K	Opal	DALI	12,320 lm	109 lm/W	112.5 W	1,349.90
1,500 mm	13674174	13674184	13674164	4000 K	Opal	DALI	12,828 lm	113 lm/W	112.5 W	1,349.90

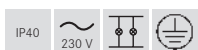

These items are subject to discount group 2.





KORI surface-mounted luminaire, 310 x 310 mm, with indirect component

Ceiling-mounted luminaire in square design with rounded corners, light emission through mouth-blown frosted opal glass with indirect light component. Shade material: Chintz; shade color: black.

You can find other deliverable shade variants and special solutions for each product online in the PDF format on our website.

Model: E14, power: 3 x maximum 40 W, dimensions: L 310 x W 310 x H 90 mm

Item no.	Color	Price €
58191000	Black shade	369.90



This item is subject to discount group 2.



KORI LED surface-mounted luminaire, 310 x 310 mm, with indirect component

Ceiling-mounted luminaire in square design with rounded corners, light emission through mouth-blown frosted opal glass with indirect light component. Switchable. Shade material: Chintz; shade color: black.

You can find other deliverable shade variants and special solutions for each product online in the PDF format on our website.

Illuminants: LED, color rendering: CRI > 80, power: 15 W, luminous flux: 1,370 lm, dimensions: L 310 x W 310 x H 90 mm

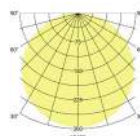

Item no.	Color	Luminous flux	Color temperature	Price €
58192003	Black shade	1,370 lm	3000 K	569.90

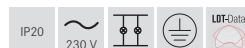

This item is subject to discount group 2.



KORI surface-mounted luminaire, 380 x 380 mm, with indirect component

Ceiling-mounted luminaire in square design with rounded corners, light emission through mouth-blown frosted opal glass with indirect light component. Shade material: Chintz, shade color: brown gray.

You can find other deliverable shade variants and special solutions for each product online in the PDF format on our website.

Model: E14, power: 4 x maximum 40 W, dimensions: L 380 x W 380 x H 95 mm

Item no.	Color	Price €
58193000	Brown gray shade	579.90



This item is subject to discount group 2.



KORI LED surface-mounted luminaire, 380 x 380 mm, with indirect component

Ceiling-mounted luminaire in square design with rounded corners, light emission through mouth-blown frosted opal glass with indirect light component. Switchable. Shade material: Chintz, shade color: brown gray.

You can find other deliverable shade variants and special solutions for each product online in the PDF format on our website.

Illuminants: LED, color rendering: CRI > 80, power: 18 W, luminous flux: 1,810 lm, dimensions: L 380 x W 380 x H 95 mm

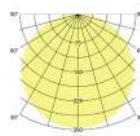

Item no.	Color	Luminous flux	Color temperature	Price €
58194003	Brown gray shade	1,810 lm	3000 K	819.90

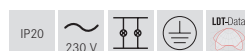

This item is subject to discount group 2.



Surface-mounted luminaire 330 mm, with indirect component

Ceiling-mounted luminaire in round design, light emission through mouth-blown frosted opal glass with indirect light component. Shade material: Chintz, shade color: dark brown gray.

You can find other deliverable shade variants and special solutions for each product online in the PDF format on our website.

Model: E27, power: 2 x maximum 60 W, dimensions: D 330 x H 70 mm

Item no.	Color	Price €
58211000	Dark brown gray shade	279.90



This item is subject to discount group 2.



LED surface-mounted luminaire 330 mm, with indirect component

Ceiling-mounted luminaire in round design, light emission through mouth-blown frosted opal glass with indirect light component. Switchable. Shade material: Chintz, shade color: dark brown gray.

You can find other deliverable shade variants and special solutions for each product online in the PDF format on our website.

Illuminants: LED, color rendering: CRI > 80, power: 15 W, dimensions: D 330 x H 70 mm

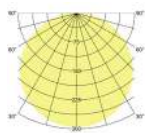

Item no.	Color	Luminous flux	Color temperature	Price €
58212003	Dark brown gray shade	1,360 lm	3000 K	469.90

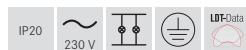

This item is subject to discount group 2.



Eiswiese (lee meadow), Göttingen



Surface-mounted luminaire 420 mm, with indirect component

Ceiling-mounted luminaire in round design, light emission through mouth-blown frosted opal glass with indirect light component. Shade material: Chintz; shade color: orange.

You can find other deliverable shade variants and special solutions for each product online in the PDF format on our website.

Model: E27, power: 3 x maximum 60 W, dimensions: D 420 x H 90 mm

Item no.	Color	Price €
58213000	Orange shade	349.90



This item is subject to discount group 2.



LED surface-mounted luminaire 420 mm, with indirect component

Ceiling-mounted luminaire in round design, light emission through mouth-blown frosted opal glass with indirect light component. Switchable. Shade material: Chintz; shade color: orange.

You can find other deliverable shade variants and special solutions for each product online in the PDF format on our website.

Illuminants: LED, color rendering: CRI > 80, power: 25 W, dimensions: D 420 x H 90 mm

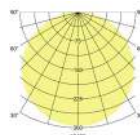

Item no.	Color	Luminous flux	Color temperature	Price €
58214003	Orange shade	1,990 lm	3000 K	589.90

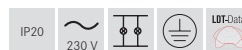

This item is subject to discount group 2.



Surface-mounted luminaire 470 mm, with indirect component

Ceiling-mounted luminaire in round design, light emission through mouth-blown frosted opal glass with indirect light component. Shade material: Chintz; shade color: lime green.

You can find other deliverable shade variants and special solutions for each product online in the PDF format on our website.

Model: E27, power: 3 x maximum 60 W, dimensions: D 470 x H 110 mm

Item no.	Color	Price €
58215744	Lime green shade	479.90



This item is subject to discount group 2.



LED surface-mounted luminaire 470 mm, with indirect component

Ceiling-mounted luminaire in round design, light emission through mouth-blown frosted opal glass with indirect light component. Switchable. Shade material: Chintz; shade color: light blue.

You can find other deliverable shade variants and special solutions for each product online in the PDF format on our website.

Illuminants: LED, color rendering: CRI > 80, power: 29 W, dimensions: D 470 x H 110 mm

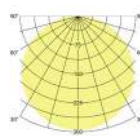

Item no.	Color	Luminous flux	Color temperature	Price €
58216737	Light blue shade	2,660 lm	3000 K	779.90

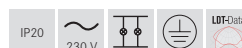

This item is subject to discount group 2.



SOFT CUBE surface-mounted luminaire, 280 x 280 mm

Square fabric luminaire for ceiling mounting. Polycarbonate film diffuser, shade material: Chintz; shade color: dark beige.

You can find other deliverable shade variants and special solutions for each product online in the PDF format on our website. Luminous flux measured with 2 x 10 W LED retrofit lamp (not included in the scope of delivery).

Model: E27, power: 2 x maximum 60 W, Dimensions: L 280 x W 280 x H 180 mm

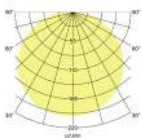

Item no.	Color	Luminous flux	Price €
58231787	Dark beige shade	1,220 lm	250.10

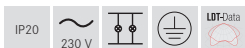

This item is subject to discount group 2.

Shade color charts 53498 for color selection (Available on request)

With these color charts, you can choose your desired shade color from all available colors.

An overview of the available colors and other special solutions can also be found online at the respective product on our website as a PDF.





SOFT CUBE surface-mounted luminaire, 380 x 380 mm

Square fabric luminaire for ceiling mounting. Polycarbonate film diffuser, shade material: Chintz, shade color: brown gray.

You can find other deliverable shade variants and special solutions for each product online in the PDF format on our website. Luminous flux measured with 3 x 10 W LED retrofit lamp (not included in the scope of delivery).

Model: E27, power: 3 x maximum 60 W, dimensions: L 380 x W 380 x H 180 mm

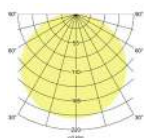

Item no.	Color	Luminous flux	Price €
58233000	Brown gray shade	1,830 lm	289.90

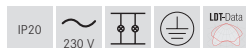

This item is subject to discount group 2.



SOFT CUBE surface-mounted luminaire, 480 x 480 mm

Square fabric luminaire for ceiling mounting. Polycarbonate film diffuser, shade material: Chintz, shade color: brown gray.

You can find other deliverable shade variants and special solutions for each product online in the PDF format on our website. Luminous flux measured with 3 x 10 W LED retrofit lamp (not included in the scope of delivery).

Model: E27, power: 3 x maximum 60 W, dimensions: L 480 x W 480 x H 180 mm

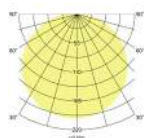

Item no.	Color	Luminous flux	Price €
58235000	Brown gray shade	1,830 lm	329.90

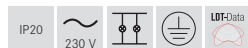

This item is subject to discount group 2.



SOFT CUBE surface-mounted luminaire, 580 x 580 mm

Square fabric luminaire for ceiling mounting. Polycarbonate film diffuser, shade material: Chintz, shade color: brown gray.

You can find other deliverable shade variants and special solutions for each product online in the PDF format on our website. Luminous flux measured with 5 x 10 W LED retrofit lamp (not included in the scope of delivery).

Model: E27, power: 5 x maximum 60 W, luminous flux: 3,040 lm, dimensions: L 580 x W 580 x H 180 mm

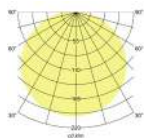

Item no.	Color	Luminous flux	Price €
58237000	Brown gray shade	3,040 lm	419.90

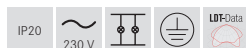

This item is subject to discount group 2.



SOFT CUBE surface-mounted luminaire, 780 x 780 mm

Square fabric luminaire for ceiling mounting. Polycarbonate film diffuser, shade material: Chintz, shade color: brown gray.

You can find other deliverable shade variants and special solutions for each product online in the PDF format on our website. Luminous flux measured with 5 x 10 W LED retrofit lamp (not included in the scope of delivery).

Illuminants: Irreplaceable LED, model: E27, power: 5 x maximum 60 W, luminous flux: 3,040 lm, dimensions: L 780 x W 780 x H 180 mm

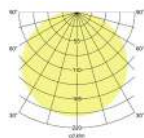

Item no.	Color	Luminous flux	Price €
58239000	Brown gray shade	3,040 lm	529.90

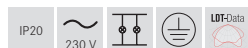

This item is subject to discount group 2.



SOFT TUBE Surface mounted luminaire, 280 mm

Cylindrical fabric luminaire for ceiling mounting. Polycarbonate film diffuser, shade material: Chintz; shade color: hazelnut.

You can find other deliverable shade variants and special solutions for each product online in the PDF format on our website. Luminous flux measured with 2 x 10 W LED retrofit lamp (not included in the scope of delivery).

Model: E27, power: 2 x maximum 60 W, luminous flux: 1,220 lm, dimensions: D 280 x H 180 mm

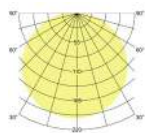

Item no.	Color	Luminous flux	Price €
58250000	Hazelnut shade	1,220 lm	229.90

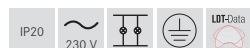

This item is subject to discount group 2.

SOFT TUBE product family

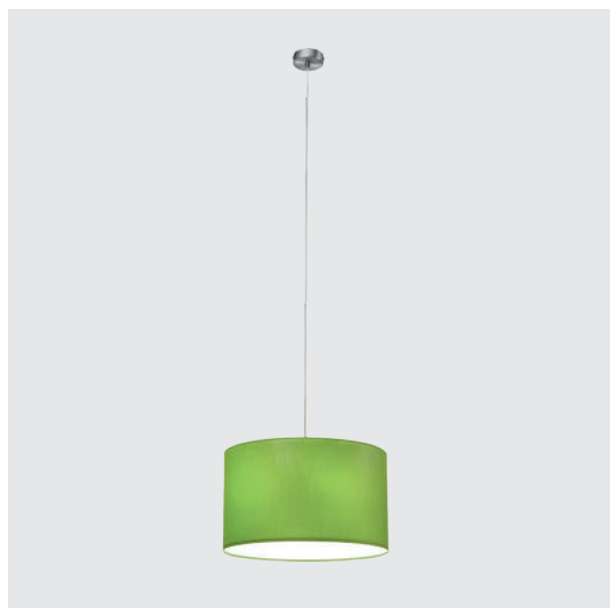

SOFT TUBE pendant luminaire, 280 mm

Item no. 58260150
See page 208





SOFT TUBE Surface mounted luminaire, 380 mm

Cylindrical fabric luminaire for ceiling mounting. Polycarbonate film diffuser, shade material: Chintz; shade color: black.

You can find other deliverable shade variants and special solutions for each product online in the PDF format on our website. Luminous flux measured with 3 x 10 W LED retrofit lamp (not included in the scope of delivery).

Model: E27, power: 3 x maximum 60 W, dimensions: D 380 x H 180 mm

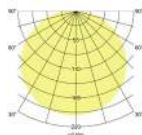

Item no.	Color	Luminous flux	Price €
58252000	Black shade	1,830 lm	269.90

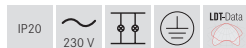

This item is subject to discount group 2.



SOFT TUBE Surface mounted luminaire, 480 mm

Cylindrical fabric luminaire for ceiling mounting. Polycarbonate film diffuser, shade material: Chintz; shade color: black.

You can find other deliverable shade variants and special solutions for each product online in the PDF format on our website. Luminous flux measured with 3 x 10 W LED retrofit lamp (not included in the scope of delivery).

Model: E27, power: 3 x maximum 60 W, dimensions: D 480 x H 180 mm

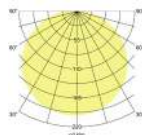

Item no.	Color	Luminous flux	Price €
58254000	Black shade	1,830 lm	301.10

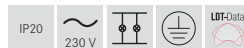

This item is subject to discount group 2.



SOFT TUBE Surface mounted luminaire, 580 mm

Cylindrical fabric luminaire for ceiling mounting. Polycarbonate film diffuser, shade material: Chintz; shade color: black.

You can find other deliverable shade variants and special solutions for each product online in the PDF format on our website. Luminous flux measured with 5 x 10 W LED retrofit lamp (not included in the scope of delivery).

Model: E27, power: 5 x maximum 60 W, dimensions: D 580 x H 180 mm

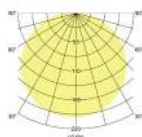

Item no.	Color	Luminous flux	Price €
58256000	Black shade	3,040 lm	389.10

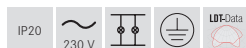

This item is subject to discount group 2.



SOFT TUBE Surface mounted luminaire, 780 mm

Cylindrical fabric luminaire for ceiling mounting. Polycarbonate film diffuser, shade material: Chintz; shade color: black.

You can find other deliverable shade variants and special solutions for each product online in the PDF format on our website. Luminous flux measured with 5 x 10 W LED retrofit lamp (not included in the scope of delivery).

Model: E27, power: 5 x maximum 60 W, dimensions: D 780 x H 180 mm

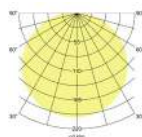

Item no.	Color	Luminous flux	Price €
58258000	Black shade	3,040 lm	489.90

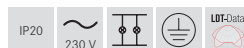

This item is subject to discount group 2.



FLAT37 LED surface-mounted panel

Illuminants: LED, color rendering: CRI > 80, power: 18 W, beam angle: 112°, material: Aluminum / plastic, delivery: including converter for connection with 230 V mains voltage, switchable and connecting terminal for through-wiring

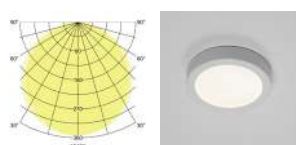

Item no.	Color	Luminous flux	Color temperature	Price €
12245073	White	1,430 lm	3000 K	79.30

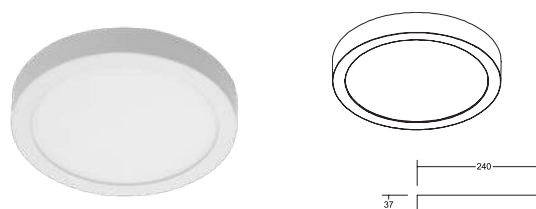

FLAT37 LED surface-mounted panel

Illuminants: LED, color rendering: CRI > 80, power: 24 W, beam angle: 110°, material: Aluminum / plastic, delivery: including converter for connection with 230 V mains voltage, switchable and connecting terminal for through-wiring

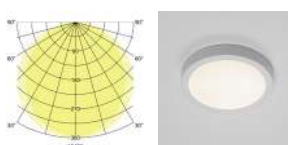

Item no.	Color	Luminous flux	Color temperature	Price €
12246073	White	2,020 lm	3000 K	101.60

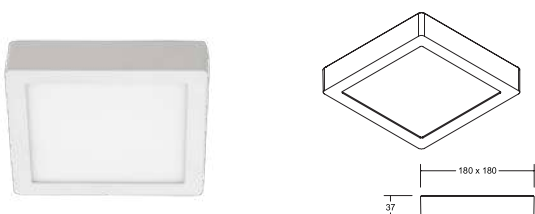

FLAT37 LED surface-mounted panel

Illuminants: LED, color rendering: CRI > 80, power: 18 W, beam angle: 105°, material: Aluminum / plastic, delivery: including converter for connection with 230 V mains voltage, switchable and connecting terminal for through-wiring

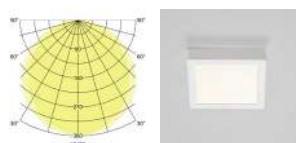

Item no.	Color	Luminous flux	Color temperature	Price €
12249073	White	1,290 lm	3000 K	89.90

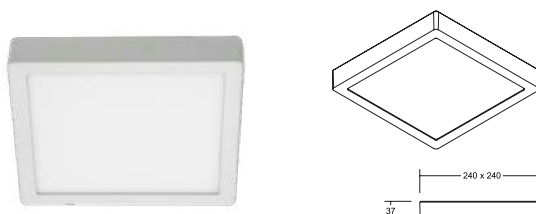

FLAT37 LED surface-mounted panel

Illuminants: LED, color rendering: CRI > 80, power: 24 W, beam angle: 105°, material: Aluminum / plastic, delivery: including converter for connection with 230 V mains voltage, switchable and connecting terminal for through-wiring

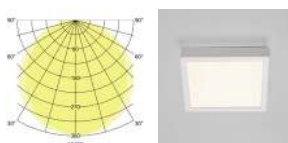

Item no.	Color	Luminous flux	Color temperature	Price €
12250073	White	1,630 lm	3000 K	109.90







Private house, Vredem

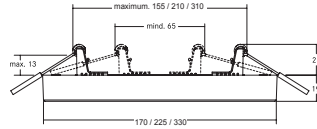

∅ 170 mm

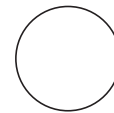

∅ 225 mm

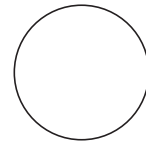

∅ 330 mm

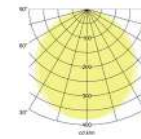
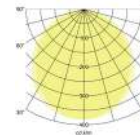
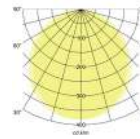

MOON LED surface-mounted downlight, dimmable phase section

NEW

The luminaire can be used as surface-mounted as well as recessed downlight.

Illuminants: LED, color: white, color rendering: CRI > 80, beam angle: 110°, material: Aluminum / plastic, delivery: including converter for connection with 230 V mains voltage, dimmable phase section.

Optional accessory: Front rings (see below), for modification of the housing color (magnetic attachment)

Sizes: Three sizes allow a flexible integration of different lumen ranges from 1,135 lm to 2,760 lm.



Item no.	Power	Luminous flux	Color temperature	Ceiling cut-out*	Installation depth*	Height	Diameter	Price €
12205073 NEW	12 W	1,135 lm	3000 K / 4000 K / 6000 K	minimum 65 mm, maximum 155 mm	25 mm	19 mm	170 mm	45.40
12206073 NEW	18 W	1,672 lm	3000 K / 4000 K / 6000 K	minimum 65 mm, maximum 210 mm	25 mm	19 mm	225 mm	63.50
12207073 NEW	24 W	2,760 lm	3000 K / 4000 K / 6000 K	minimum 65 mm, maximum 310 mm	25 mm	19 mm	330 mm	94.90

* for recessed mounting

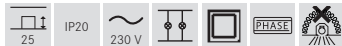

Chromium



Black



Nickel matte

Front rings: Color selection (magnetic attachment)

Item no.	Description	Price €
81020502 NEW	Front ring for 12205... chromium, round	13.70
81020508 NEW	Front ring for 12205... black, round	13.70
81020515 NEW	Front ring for 12205... nickel matte, round	13.70
81020602 NEW	Front ring for 12206... chromium, round	15.80
81020608 NEW	Front ring for 12206... black, round	15.80
81020615 NEW	Front ring for 12206... nickel matte, round	15.80
81020702 NEW	Front ring for 12207... chromium, round	21.10
81020708 NEW	Front ring for 12207... black, round	21.10
81020715 NEW	Front ring for 12207... nickel matte, round	21.10

Recessed mounting: Luminaires can be installed very easily thanks to the integrated fuse suspension. Luminaires can be installed by one person, as the fuse suspension is hooked onto the spring. The round cut-out can be flexibly adjusted on the luminaire. This allows it to be used in an existing hole size from 65 to a maximum of 310 millimeters.

Surface mounting: First, the supplied installation springs are removed. The luminaire can be easily attached to the ceiling with the mounting bracket.



1

Interior lighting

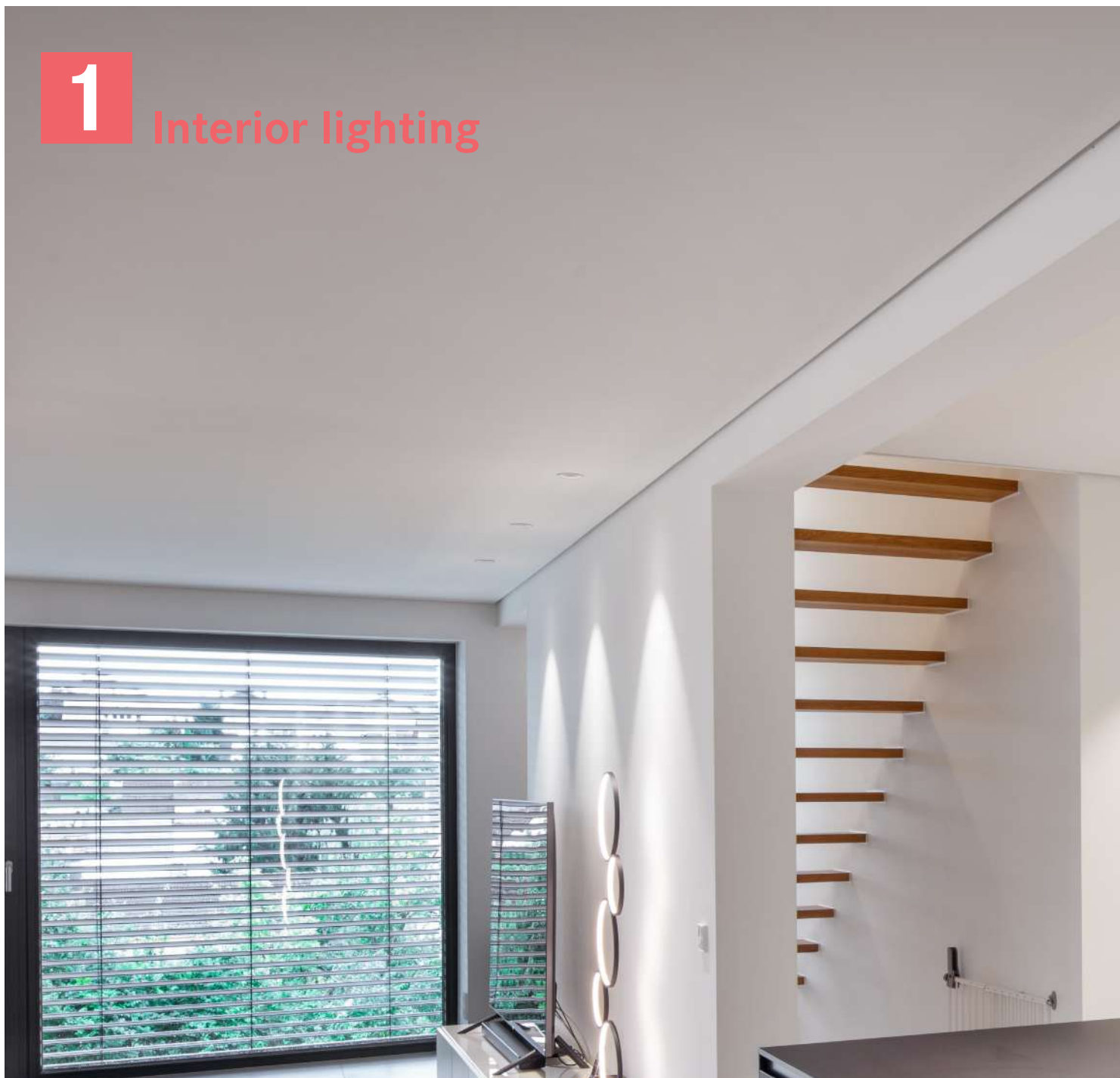

03

Pendant luminaires.

Design, functionality and illumination quality.

Pendant luminaires
Surface luminaires

Page 198
Page 204

Ring luminaires / BIRO Circle
Shade luminaires

Page 206
Page 208



Private house, Kirchard

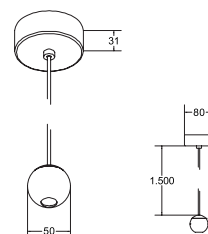
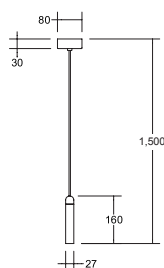
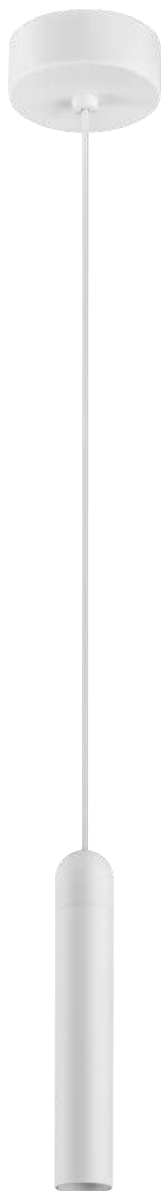

CUBA LED pendant luminaire

NEW

Illuminants: LED, color rendering: CRI > 80, power: 4.2 W, beam angle: 38°, material: Aluminum, Delivery: including converter for connection with 230 V mains voltage, switchable and 1,500 mm pendant suspension

You will find suitable CUBA products on pages 78, 79, 179 and 237.

Item no.	Color	Luminous flux	Color temperature	Price €
12309173	NEW Structural white	220 lm	3000 K	103.80
12309183	NEW Structural black	220 lm	3000 K	103.80



BALL LED pendant luminaire

NEW

Illuminants: LED, color rendering: CRI > 90, power: 4.5 W, beam angle: 38°, material: Aluminum / Steel / Plastic, Delivery: including converter for connection with 230 V mains voltage, switchable and 1,500 mm pendant suspension

Item no.	Color	Luminous flux	Color temperature	Price €
12119173	NEW Structural white	220 lm	3000 K	88.00
12119183	NEW Structural black	220 lm	3000 K	88.00
12119823	NEW Structural black chromium	220 lm	3000 K	99.00
12119893	NEW Structural black / rosé gold	220 lm	3000 K	99.00



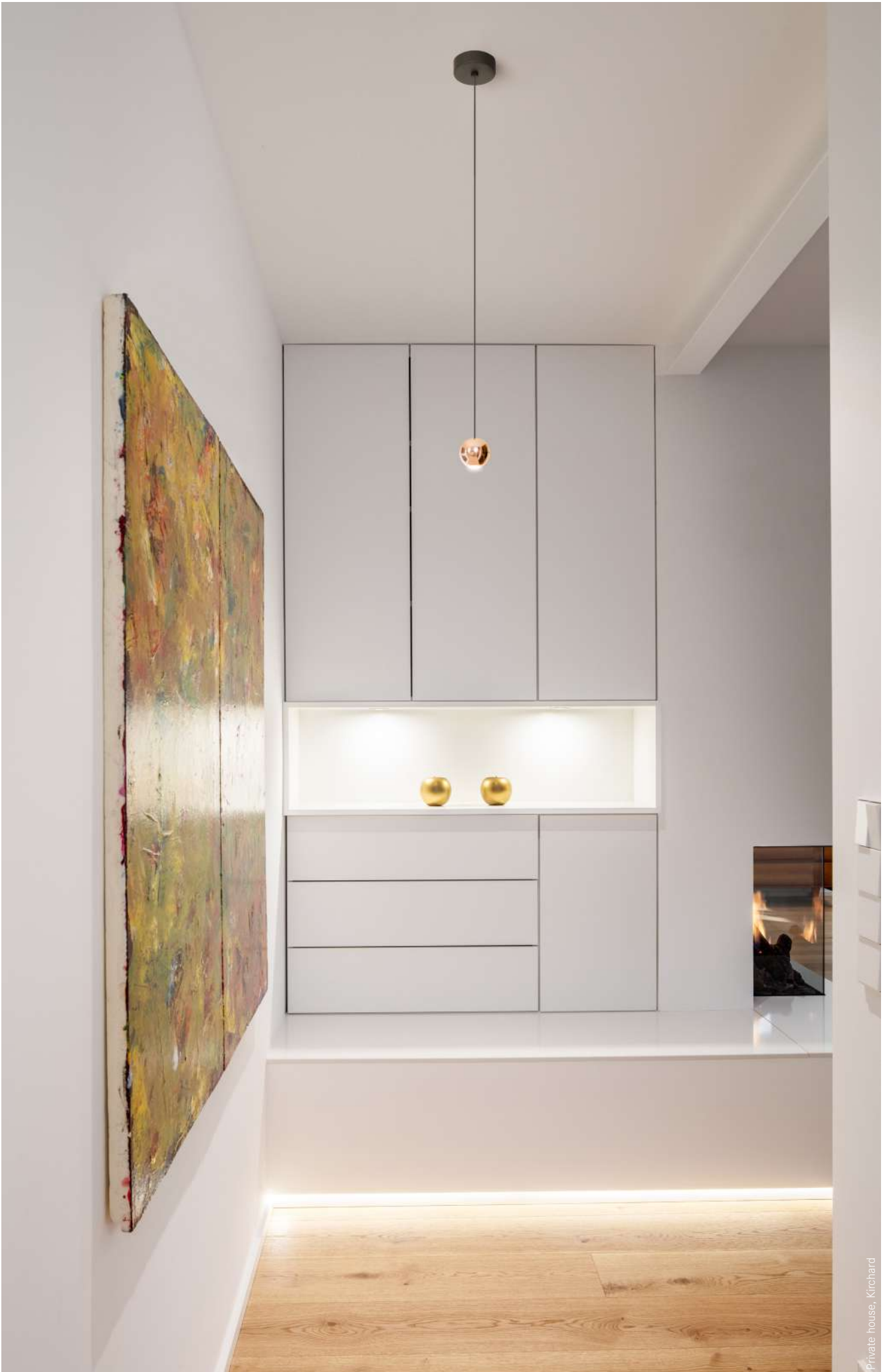



Borussia Mönchengladbach, Sports bar

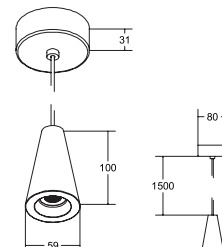
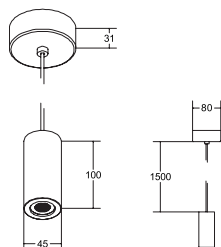

KONGRET LED pendant luminaire

Illuminants: LED, color rendering: CRI > 90, power: 4.5 W, beam angle: 38°, material: Concrete / aluminum / plastic, Delivery: including converter for connection with 230 V mains voltage, switchable and 1,500 mm pendant suspension

You will find suitable ceiling-mounted recessed and wall-mounted luminaires on pages 14 and 227.

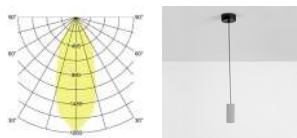

Item no.	Color	Luminous flux	Color temperature	Price €
12111733	Concrete / structural black	220 lm	3000 K	92.00



KONGRET LED pendant luminaire

Illuminants: LED, color rendering: CRI > 90, power: 4.5 W, beam angle: 38°, material: Concrete / aluminum / plastic, Delivery: including converter for connection with 230 V mains voltage, switchable and 1,500 mm pendant suspension

You will find suitable ceiling-mounted recessed and wall-mounted luminaires on pages 14 and 227.

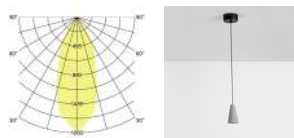

Item no.	Color	Luminous flux	Color temperature	Price €
12112733	Concrete / structural black	220 lm	3000 K	92.00



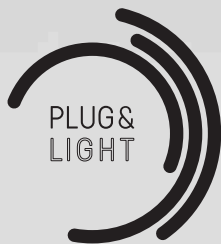
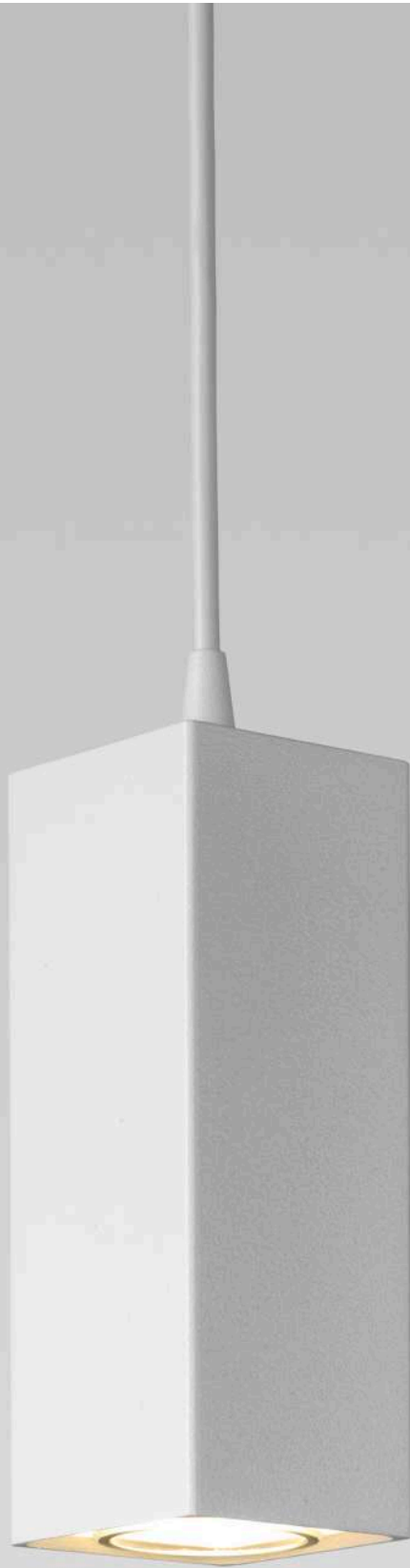

DEVELOPED BY
INSTA

FEATURED BY
GIRA & JUNG

MEMBER
BRUMBERG



BOWL Plug & Light LED pendant luminaire

Attention: only to be used in combination with the Plug & Light system of GIRA and JUNG. Dimming function can be called via corresponding components from GIRA or JUNG.

Illuminants: LED, color rendering: CRI > 85, power: 7 W, beam angle: 35°, material: Aluminum / Glass, Delivery: including 1,500-mm pendant suspension

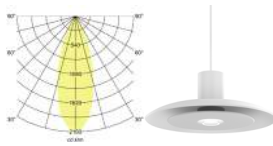

Item no.	Color	Luminous flux	Color temperature	Price €
12717173	Structural white	480 lm	3000 K	306.20

IP20 12 V III LDT-Data This item is subject to discount group 2. Design: Alexander Grimm (Lounge Design)

Deliverable accessory: Bracket with magnet for Plug & Light
Item no. 81077000, price €: 10.50 (RG2)

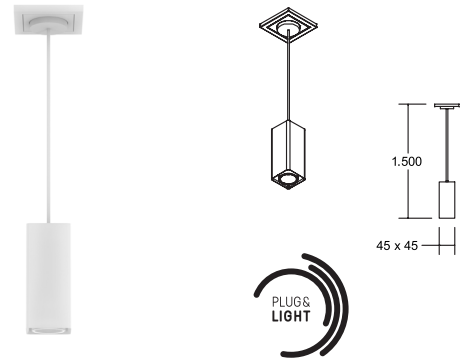

MINIQ Plug & Light LED pendant luminaire

Attention: only to be used in combination with the Plug & Light system of GIRA and JUNG. Dimming function can be called via corresponding components from GIRA or JUNG.

Illuminants: LED, color rendering: CRI > 85, power: 4 W, beam angle: 35°, material: Aluminum / Glass, Delivery: including 1,500-mm pendant suspension

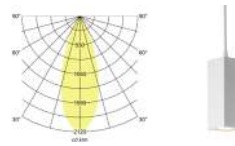

Item no.	Color	Luminous flux	Color temperature	Price €
12711173	Structural white	200 lm	3000 K	262.30

IP20 12 V III LDT-Data This item is subject to discount group 2. Design: Alexander Grimm (Lounge Design)

Deliverable accessory: Bracket with magnet for Plug & Light
Item no. 81077000, price €: 10.50 (RG2)

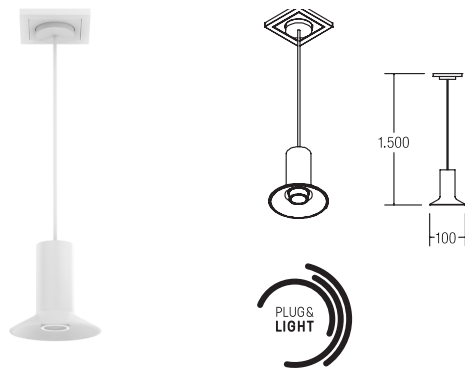

GRAMMO Plug & Light LED pendant luminaire

Attention: only to be used in combination with the Plug & Light system of GIRA and JUNG. Dimming function can be called via corresponding components from GIRA or JUNG.

Illuminants: LED, color rendering: CRI > 85, power: 4 W, beam angle: 35°, material: Aluminum / Glass, Delivery: including 1,500-mm pendant suspension

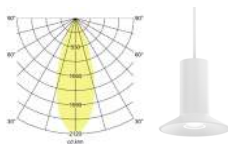

Item no.	Color	Luminous flux	Color temperature	Price €
12713173	Structural white	200 lm	3000 K	262.30

IP20 12 V III LDT-Data This item is subject to discount group 2. Design: Alexander Grimm (Lounge Design)

Deliverable accessory: Bracket with magnet for Plug & Light
Item no. 81077000, price €: 10.50 (RG2)



GRAMMO Plug & Light LED pendant luminaire

Attention: only to be used in combination with the Plug & Light system of GIRA and JUNG. Dimming function can be called via corresponding components from GIRA or JUNG.

Illuminants: LED, color rendering: CRI > 85, power: 8 W, beam angle: 35°, material: Aluminum / Glass, Delivery: including 1,500-mm pendant suspension

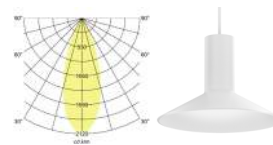

Item no.	Color	Luminous flux	Color temperature	Price €
12723173	Structural white	400 lm	3000 K	273.30

IP20 12 V III LDT-Data This item is subject to discount group 2. Design: Alexander Grimm (Lounge Design)

Deliverable accessory: Bracket with magnet for Plug & Light
Item no. 81077000, price €: 10.50 (RG2)

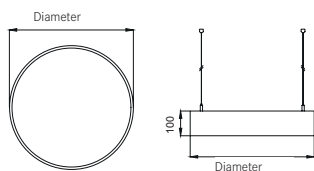

BIRO CIRCLE surface-mounted surface luminaire
See page 180

BIRO CIRCLE suspension surface luminaire, direct NEW

Illuminants: LED, input voltage: 220 - 240 V AC, 50 - 60 Hz, color rendering: CRI > 80, beam angle: 116°, cover: PMMA, opal, material: Aluminum / Steel / Plastic, suspension length: 5,000 mm, delivery: including decentralized canopy (central canopy on request)

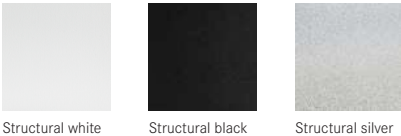
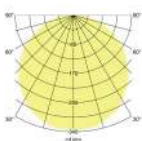

Diameter	Item no. structural white	Item no. structural black	Item no. structural silver	Color temperature	Cover	Controlling	Luminous flux	System efficiency	System power	Price in €
450 mm	13605173	13605183	13605163	3000 K	Opal	Switchable	2,450 lm	98 lm/W	25 W	359.90
450 mm	13605174	13605184	13605164	4000 K	Opal	Switchable	2,550 lm	102 lm/W	25 W	359.90
450 mm	13615173	13615183	13615163	3000 K	Opal	DALI	2,450 lm	98 lm/W	25 W	439.90
450 mm	13615174	13615184	13615164	4000 K	Opal	DALI	2,550 lm	102 lm/W	25 W	439.90
600 mm	13600173	13600183	13600163	3000 K	Opal	Switchable	5,186 lm	103 lm/W	50 W	529.90
600 mm	13600174	13600184	13600164	4000 K	Opal	Switchable	5,400 lm	108 lm/W	50 W	529.90
600 mm	13610173	13610183	13610163	3000 K	Opal	DALI	5,186 lm	103 lm/W	50 W	609.90
600 mm	13610174	13610184	13610164	4000 K	Opal	DALI	5,400 lm	108 lm/W	50 W	609.90
750 mm	13601173	13601183	13601163	3000 K	Opal	Switchable	7,328 lm	104 lm/W	70 W	629.90
750 mm	13601174	13601184	13601164	4000 K	Opal	Switchable	7,630 lm	109 lm/W	70 W	629.90
750 mm	13611173	13611183	13611163	3000 K	Opal	DALI	7,328 lm	104 lm/W	70 W	729.90
750 mm	13611174	13611184	13611164	4000 K	Opal	DALI	7,630 lm	109 lm/W	70 W	729.90
1,000 mm	13602173	13602183	13602163	3000 K	Opal	Switchable	13,925 lm	111 lm/W	125 W	1,079.00
1,000 mm	13602174	13602184	13602164	4000 K	Opal	Switchable	14,500 lm	116 lm/W	125 W	1,079.00
1,000 mm	13612173	13612183	13612163	3000 K	Opal	DALI	13,925 lm	111 lm/W	125 W	1,219.00
1,000 mm	13612174	13612184	13612164	4000 K	Opal	DALI	14,500 lm	116 lm/W	125 W	1,219.00
1,200 mm	13603173	13603183	13603163	3000 K	Opal	Switchable	19,650 lm	112 lm/W	175 W	1,380.00
1,200 mm	13603174	13603184	13603164	4000 K	Opal	Switchable	20,475 lm	117 lm/W	175 W	1,380.00
1,200 mm	13613173	13613183	13613163	3000 K	Opal	DALI	19,650 lm	112 lm/W	175 W	1,489.00
1,200 mm	13613174	13613184	13613164	4000 K	Opal	DALI	20,475 lm	117 lm/W	175 W	1,489.00
1,500 mm	13604173	13604183	13604163	3000 K	Opal	Switchable	28,550 lm	118 lm/W	240 W	1,829.00
1,500 mm	13604174	13604184	13604164	4000 K	Opal	Switchable	29,760 lm	124 lm/W	240 W	1,829.00
1,500 mm	13614173	13614183	13614163	3000 K	Opal	DALI	28,550 lm	118 lm/W	240 W	2,009.00
1,500 mm	13614174	13614184	13614164	4000 K	Opal	DALI	29,760 lm	124 lm/W	240 W	2,009.00

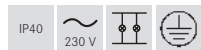

These items are subject to discount group 2.

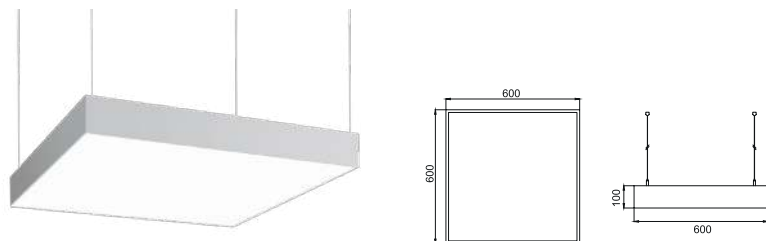

BIRO SQUARE pendant surface luminaire
600 x 600 mm, direct

NEW

BIRO SQUARE surface-mounted surface luminaire
See page 181

Illuminants: LED, input voltage: 220 - 240 V AC, 50 - 60 Hz, color rendering: CRI > 80, power: 44 W, beam angle: 114°, cover: PMMA, opal, material: Aluminum / Plastic, Suspension length: 5,000 mm, delivery: including decentralized canopy (central canopy on request)

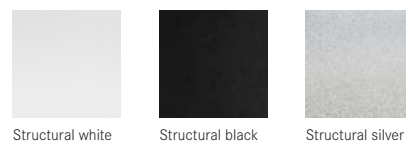
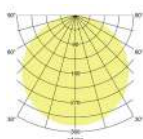

Item no. structural white	Item no. structural black	Item no. structural silver	Color temperature	Cover	Controlling	Luminous flux	System efficiency	Price in €
13720173	13720183	13720163	3000 K	Opal	Switchable	5,240 lm	119 lm/W	289.90
13720174	13720184	13720164	4000 K	Opal	Switchable	5,456 lm	124 lm/W	289.90
13730173	13730183	13730163	3000 K	Opal	DALI	5,240 lm	119 lm/W	349.90
13730174	13730184	13730164	4000 K	Opal	DALI	5,456 lm	124 lm/W	349.90



Also available on request in dimensions 300 x 300 mm (power: 12 W).

These items are subject to discount group 2.

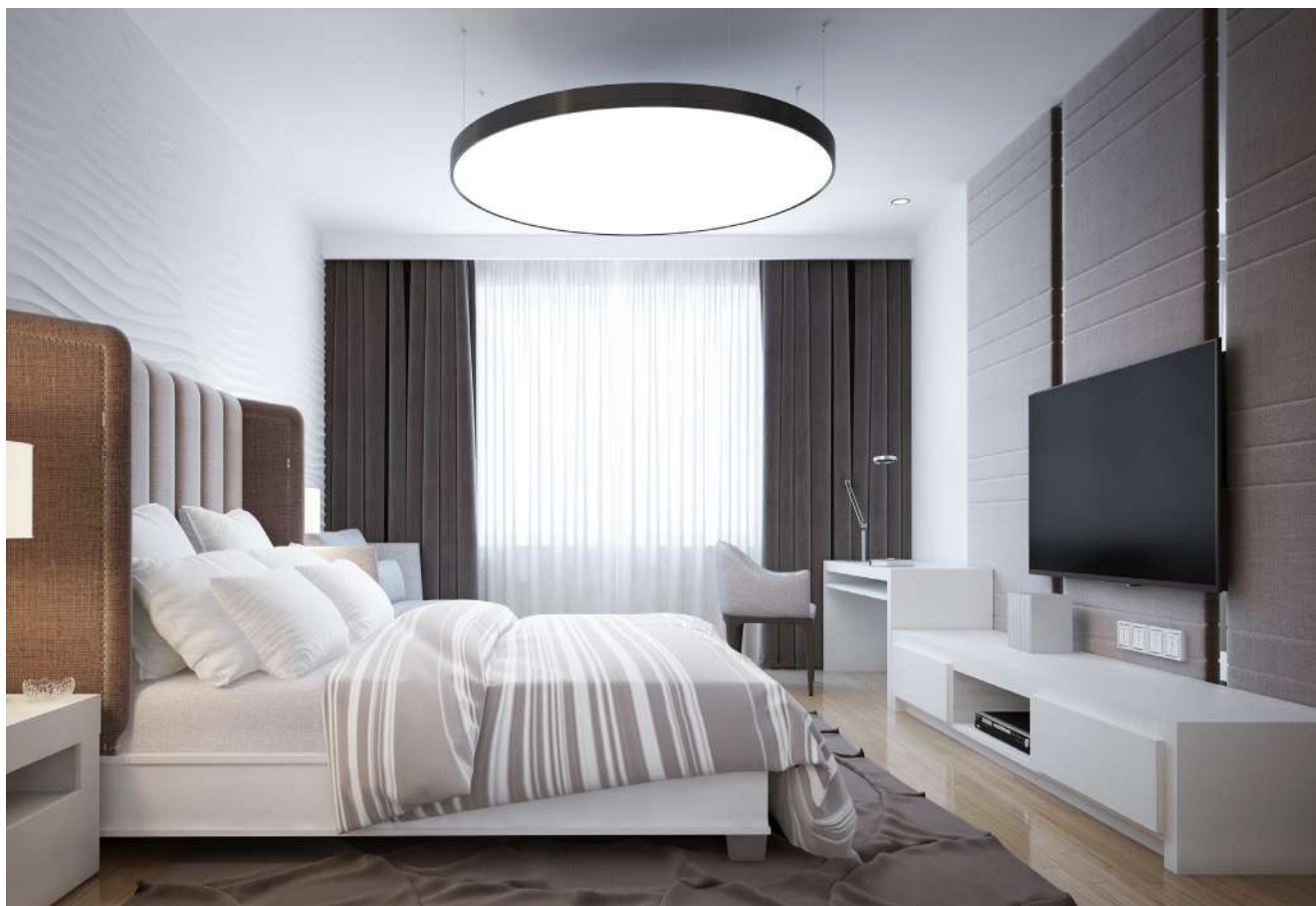

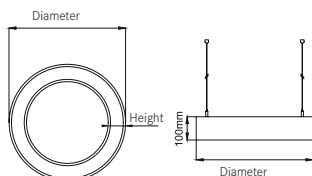

BIRO CIRCLE suspension ring luminaire, direct NEW

Illuminants: LED, input voltage: 220 - 240 V AC, 50 - 60 Hz, color rendering: CRI > 80, beam angle: 108°, cover: PMMA, opal, material: Aluminum / Steel / Plastic, suspension length: 5,000 mm, delivery: including decentralized canopy (central canopy on request)

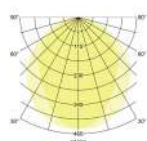

Diameter	Item no. structural white	Item no. structural black	Item no. structural silver	Color temperature	Cover	Controlling	Luminous flux	System efficiency	System power	Price in €
450 mm	13625173	13625183	13625163	3000 K	Opal	Switchable	1,250 lm	100 lm/W	12.5 W	409.90
450 mm	13625174	13625184	13625164	4000 K	Opal	Switchable	1,300 lm	104 lm/W	12.5 W	409.90
450 mm	13635173	13635183	13635163	3000 K	Opal	DALI	1,250 lm	100 lm/W	12.5 W	509.90
450 mm	13635174	13635184	13635164	4000 K	Opal	DALI	1,300 lm	104 lm/W	12.5 W	509.90
600 mm	13620173	13620183	13620163	3000 K	Opal	Switchable	2,545 lm	101 lm/W	25 W	549.90
600 mm	13620174	13620184	13620164	4000 K	Opal	Switchable	2,650 lm	106 lm/W	25 W	549.90
600 mm	13630173	13630183	13630163	3000 K	Opal	DALI	2,545 lm	101 lm/W	25 W	649.90
600 mm	13630174	13630184	13630164	4000 K	Opal	DALI	2,650 lm	106 lm/W	25 W	649.90
750 mm	13621173	13621183	13621163	3000 K	Opal	Switchable	4,150 lm	103 lm/W	40 W	639.90
750 mm	13621174	13621184	13621164	4000 K	Opal	Switchable	4,320 lm	108 lm/W	40 W	639.90
750 mm	13631173	13631183	13631163	3000 K	Opal	DALI	4,150 lm	103 lm/W	40 W	739.90
750 mm	13631174	13631184	13631164	4000 K	Opal	DALI	4,320 lm	108 lm/W	40 W	739.90
1,000 mm	13622173	13622183	13622163	3000 K	Opal	Switchable	6,603 lm	105 lm/W	62.5 W	799.90
1,000 mm	13622174	13622184	13622164	4000 K	Opal	Switchable	6,875 lm	110 lm/W	62.5 W	799.90
1,000 mm	13632173	13632183	13632163	3000 K	Opal	DALI	6,603 lm	105 lm/W	62.5 W	899.90
1,000 mm	13632174	13632184	13632164	4000 K	Opal	DALI	6,875 lm	110 lm/W	62.5 W	899.90
1,200 mm	13623173	13623183	13623163	3000 K	Opal	Switchable	8,067 lm	107 lm/W	75 W	949.90
1,200 mm	13623174	13623184	13623164	4000 K	Opal	Switchable	8,400 lm	112 lm/W	75 W	949.90
1,200 mm	13633173	13633183	13633163	3000 K	Opal	DALI	8,067 lm	107 lm/W	75 W	1,049.90
1,200 mm	13633174	13633184	13633164	4000 K	Opal	DALI	8,400 lm	112 lm/W	75 W	1,049.90
1,500 mm	13624173	13624183	13624163	3000 K	Opal	Switchable	12,320 lm	109 lm/W	112.5 W	1,180.00
1,500 mm	13624174	13624184	13624164	4000 K	Opal	Switchable	12,828 lm	113 lm/W	112.5 W	1,180.00
1,500 mm	13634173	13634183	13634163	3000 K	Opal	DALI	12,320 lm	109 lm/W	112.5 W	1,380.00
1,500 mm	13634174	13634184	13634164	4000 K	Opal	DALI	12,828 lm	113 lm/W	112.5 W	1,380.00



These items are subject to discount group 2.

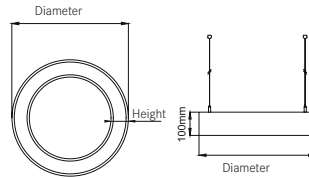

BIRO CIRCLE suspension ring luminaire, direct/indirect

NEW

Illuminants: LED, input voltage: 220 - 240 V AC, 50 - 60 Hz, color rendering: CRI > 80, beam angle: 108°, cover: PMMA, opal, material: Aluminum / Steel / Plastic, suspension length: 5,000 mm, delivery: including decentralized canopy (central canopy on request)

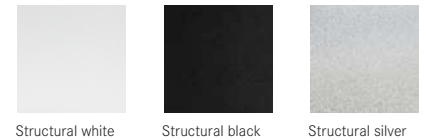

Diameter	Item no. structural white	Item no. structural black	Item no. structural silver	Color temperature	Cover	Controlling	Luminous flux	System efficiency	System power	Price in €
450 mm	13645173	13645183	13645163	3000 K	Opal	Switchable	1,250 lm	100 lm/W	25 W	549.90
450 mm	13645174	13645184	13645164	4000 K	Opal	Switchable	1,300 lm	104 lm/W	25 W	549.90
450 mm	13655173	13655183	13655163	3000 K	Opal	DALI	1,250 lm	100 lm/W	25 W	649.90
450 mm	13655174	13655184	13655164	4000 K	Opal	DALI	1,300 lm	104 lm/W	25 W	649.90
600 mm	13640173	13640183	13640163	3000 K	Opal	Switchable	2,545 lm	101 lm/W	50 W	669.90
600 mm	13640174	13640184	13640164	4000 K	Opal	Switchable	2,650 lm	106 lm/W	50 W	669.90
600 mm	13650173	13650183	13650163	3000 K	Opal	DALI	2,545 lm	101 lm/W	50 W	769.90
600 mm	13650174	13650184	13650164	4000 K	Opal	DALI	2,650 lm	106 lm/W	50 W	769.90
750 mm	13641173	13641183	13641163	3000 K	Opal	Switchable	4,150 lm	103 lm/W	80 W	779.90
750 mm	13641174	13641184	13641164	4000 K	Opal	Switchable	4,320 lm	108 lm/W	80 W	779.90
750 mm	13651173	13651183	13651163	3000 K	Opal	DALI	4,150 lm	103 lm/W	80 W	879.90
750 mm	13651174	13651184	13651164	4000 K	Opal	DALI	4,320 lm	108 lm/W	80 W	879.90
1,000 mm	13642173	13642183	13642163	3000 K	Opal	Switchable	6,603 lm	105 lm/W	125 W	1,049.00
1,000 mm	13642174	13642184	13642164	4000 K	Opal	Switchable	6,875 lm	110 lm/W	125 W	1,049.00
1,000 mm	13652173	13652183	13652163	3000 K	Opal	DALI	6,603 lm	105 lm/W	125 W	1,249.00
1,000 mm	13652174	13652184	13652164	4000 K	Opal	DALI	6,875 lm	110 lm/W	125 W	1,249.00
1,200 mm	13643173	13643183	13643163	3000 K	Opal	Switchable	8,067 lm	107 lm/W	150 W	1,229.00
1,200 mm	13643174	13643184	13643164	4000 K	Opal	Switchable	8,400 lm	112 lm/W	150 W	1,229.00
1,200 mm	13653173	13653183	13653163	3000 K	Opal	DALI	8,067 lm	107 lm/W	150 W	1,429.00
1,200 mm	13653174	13653184	13653164	4000 K	Opal	DALI	8,400 lm	112 lm/W	150 W	1,429.00
1,500 mm	13644173	13644183	13644163	3000 K	Opal	Switchable	12,320 lm	109 lm/W	225 W	1,579.00
1,500 mm	13644174	13644184	13644164	4000 K	Opal	Switchable	12,828 lm	113 lm/W	225 W	1,579.00
1,500 mm	13654173	13654183	13654163	3000 K	Opal	DALI	12,320 lm	109 lm/W	225 W	1,979.00
1,500 mm	13654174	13654184	13654164	4000 K	Opal	DALI	12,828 lm	113 lm/W	225 W	1,979.00



These items are subject to discount group 2.



SOFT TUBE pendant luminaire, 280 mm

Fabric pendant luminaire in cylindrical shape.
 Polycarbonate film diffuser. Shade material: Chintz;
 Shade color: lime green, suspension length: 1,500 mm.

You can find other deliverable shade variants and special solutions for each product online in the PDF format on our website.
 Luminous flux measured with 1 x 10 W LED retrofit lamp (not included in the scope of delivery).

Model: E27, power: 1 x maximum 60 W, dimensions: D 280 x H 180 mm

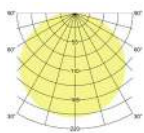

Item no.	Color	Luminous flux	Price €
58260150	Nickel matte / lime green shade	610 lm	279.90

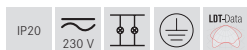

This item is subject to discount group 2.



SOFT TUBE pendant luminaire, 380 mm

Fabric pendant luminaire in cylindrical shape.
 Polycarbonate film diffuser. Shade material: Chintz;
 Shade color: lime green, suspension length: 1,500 mm.

You can find other deliverable shade variants and special solutions for each product online in the PDF format on our website.
 Luminous flux measured with 1 x 10 W LED retrofit lamp (not included in the scope of delivery).

Model: E27, power: 1 x maximum 60 W, dimensions: D 380 x H 180 mm

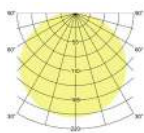

Item no.	Color	Luminous flux	Price €
58262150	Nickel matte / lime green shade	610 lm	301.10

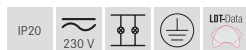

This item is subject to discount group 2.



SOFT TUBE pendant luminaire, 480 mm

Fabric pendant luminaire in cylindrical shape.
 Polycarbonate film diffuser. Shade material: Chintz;
 Shade color: dark brown gray, suspension length: 1,500 mm.

You can find other deliverable shade variants and special solutions for each product online in the PDF format on our website.
 Luminous flux measured with 3 x 10 W LED retrofit lamp (not included in the scope of delivery).

Model: E27, power: 3 x maximum 60 W, dimensions: D 480 x H 180 mm

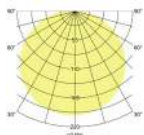

Item no.	Color	Luminous flux	Price €
58264150	White/dark brown gray shade	1,830 lm	469.90

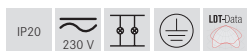

This item is subject to discount group 2.



SOFT TUBE pendant luminaire, 580 mm

Fabric pendant luminaire in cylindrical shape.
 Polycarbonate film diffuser. Shade material: Chintz;
 Shade color: dark brown gray, suspension length: 1,500 mm.

You can find other deliverable shade variants and special solutions for each product online in the PDF format on our website.
 Luminous flux measured with 5 x 10 W LED retrofit lamp (not included in the scope of delivery).

Model: E27, power: 5 x maximum 60 W, dimensions: D 580 x H 180 mm

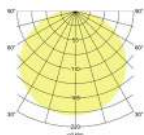

Item no.	Color	Luminous flux	Price €
58266150	Nickel matte / dark brown gray shade	3,040 lm	539.90

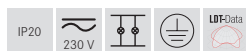

This item is subject to discount group 2.



SOFT TUBE pendant luminaire, 780 mm

Fabric pendant luminaire in cylindrical shape.
 Polycarbonate film diffuser. Shade material: Chintz;
 Shade color: dark brown gray, suspension length: 1,500 mm.

You can find other deliverable shade variants and special solutions for each product online in the PDF format on our website.
 Luminous flux measured with 5 x 10 W LED retrofit lamp (not included in the scope of delivery).

Model: E27, power: 5 x maximum 60 W, dimensions: D 780 x H 180 mm

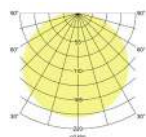

Item no.	Color	Luminous flux	Price €
58268150	Nickel matte / dark brown gray shade	3,040 lm	649.90

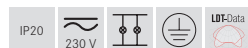

This item is subject to discount group 2.

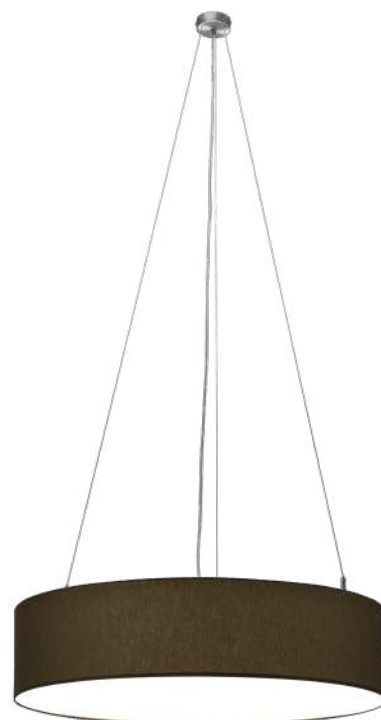

1

Interior lighting

04

Wall-mounted luminaires.

Set accents, secure paths and illuminate selectively.

Wall-mounted recessed luminaire

Page 212

Reading lamps

Page 236

Wall surface-mounted luminaires

Page 220

Mirror luminaires

Page 242

Shade luminaires

Page 232



Private house, Coesfeld

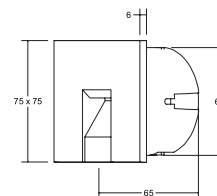
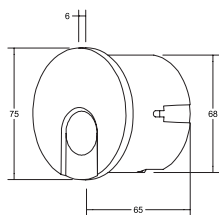

WALL KIT68 wall-mounted recessed luminaire, for device sockets

For installation in hollow wall or concrete device sockets with an installation depth of at least 62 mm (screw spacing: 60 mm). Compatible with Kaiser device sockets for installation in hollow wall, item no. 9064-02 or 9464-02, or installation in concrete, item no. 1556-04.

Caution: The delivery is WITHOUT the device socket.

Illuminants: LED, color rendering: CRI > 90, power: 1.5 W, material: Aluminum / Steel / Plastic

WALL KIT68 wall-mounted recessed luminaire, for device sockets

For installation in hollow wall or concrete device sockets with an installation depth of at least 62 mm (screw spacing: 60 mm). Compatible with Kaiser device sockets for installation in hollow wall, item no. 9064-02 or 9464-02, or installation in concrete, item no. 1556-04.

Caution: The delivery is WITHOUT the device socket.

Illuminants: LED, color rendering: CRI > 90, power: 1.5 W, material: Aluminum / Steel / Plastic

Item no.	Color	Luminous flux	Color temperature	Price €
10156073	White	70 lm	3000 K	104.90
10156083	Black	70 lm	3000 K	104.90



Note: Illustrated with the Kaiser socket 9064-02 in the sketch. However, this is NOT included in the scope of delivery of the luminaire!

Item no.	Color	Luminous flux	Color temperature	Price €
10157073	White	70 lm	3000 K	104.90
10157083	Black	70 lm	3000 K	104.90



Note: Illustrated with the Kaiser socket 9064-02 in the sketch. However, this is NOT included in the scope of delivery of the luminaire!



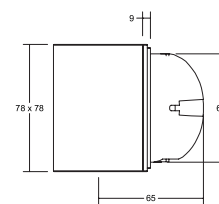
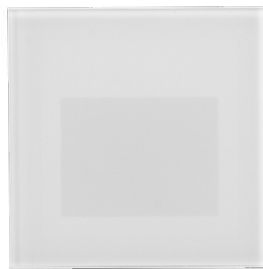
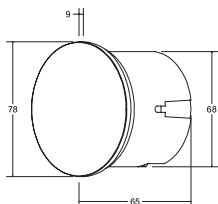

WALL KIT68 wall-mounted recessed luminaire, for device sockets

For installation in hollow wall or concrete device sockets with an installation depth of at least 62 mm (screw spacing: 60 mm). Compatible with Kaiser device sockets for installation in hollow wall, item no. 9064-02 or 9464-02, or installation in concrete, item no. 1556-04.
Caution: The delivery is WITHOUT the device socket.

Illuminants: LED, color rendering: CRI > 90, power: 1.5 W, material: Aluminum / Steel / Glass / Plastic, delivery: including cover glass

WALL KIT68 wall-mounted recessed luminaire, for device sockets

For installation in hollow wall or concrete device sockets with an installation depth of at least 62 mm (screw spacing: 60 mm). Compatible with Kaiser device sockets for installation in hollow wall, item no. 9064-02 or 9464-02, or installation in concrete, item no. 1556-04.
Caution: The delivery is WITHOUT the device socket.

Illuminants: LED, color rendering: CRI > 90, power: 1.5 W, material: Aluminum / Steel / Glass / Plastic, delivery: including cover glass

Item no.	Color	Luminous flux	Color temperature	Price €
10158073	White	35 lm	3000 K	104.90
10158083	Black	35 lm	3000 K	104.90



Note: Illustrated with the Kaiser socket 9064-02 in the sketch. However, this is NOT included in the scope of delivery of the luminaire!

Item no.	Color	Luminous flux	Color temperature	Price €
10159073	White	35 lm	3000 K	104.90
10159083	Black	35 lm	3000 K	104.90



Note: Illustrated with the Kaiser socket 9064-02 in the sketch. However, this is NOT included in the scope of delivery of the luminaire!

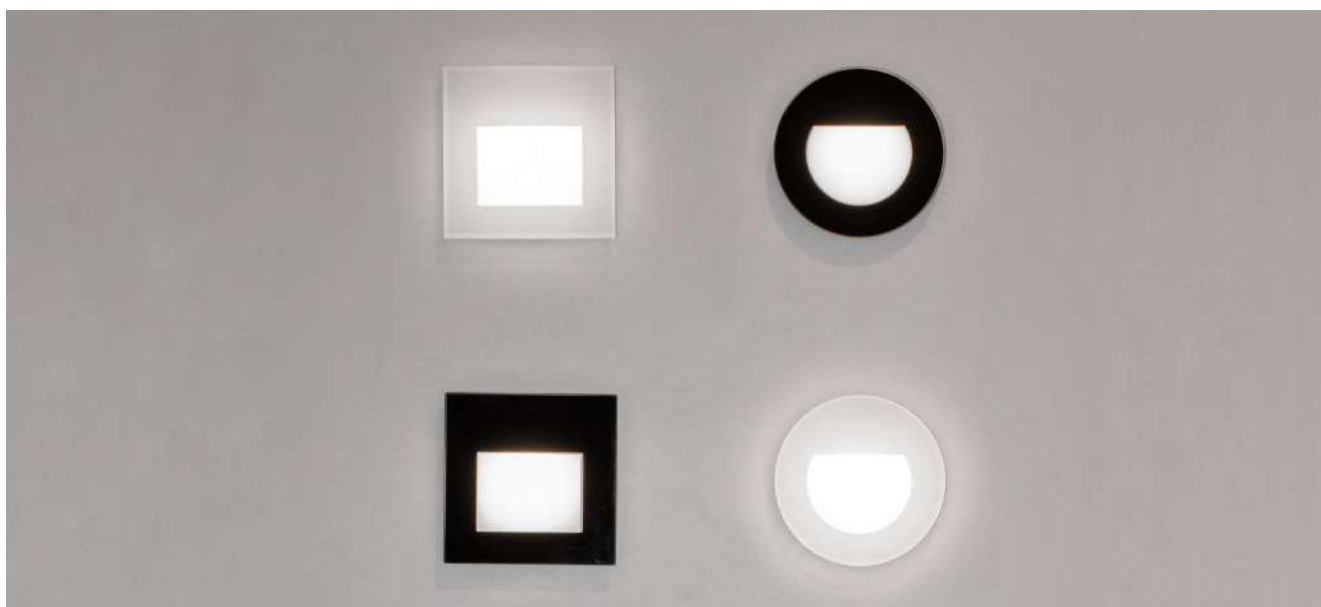

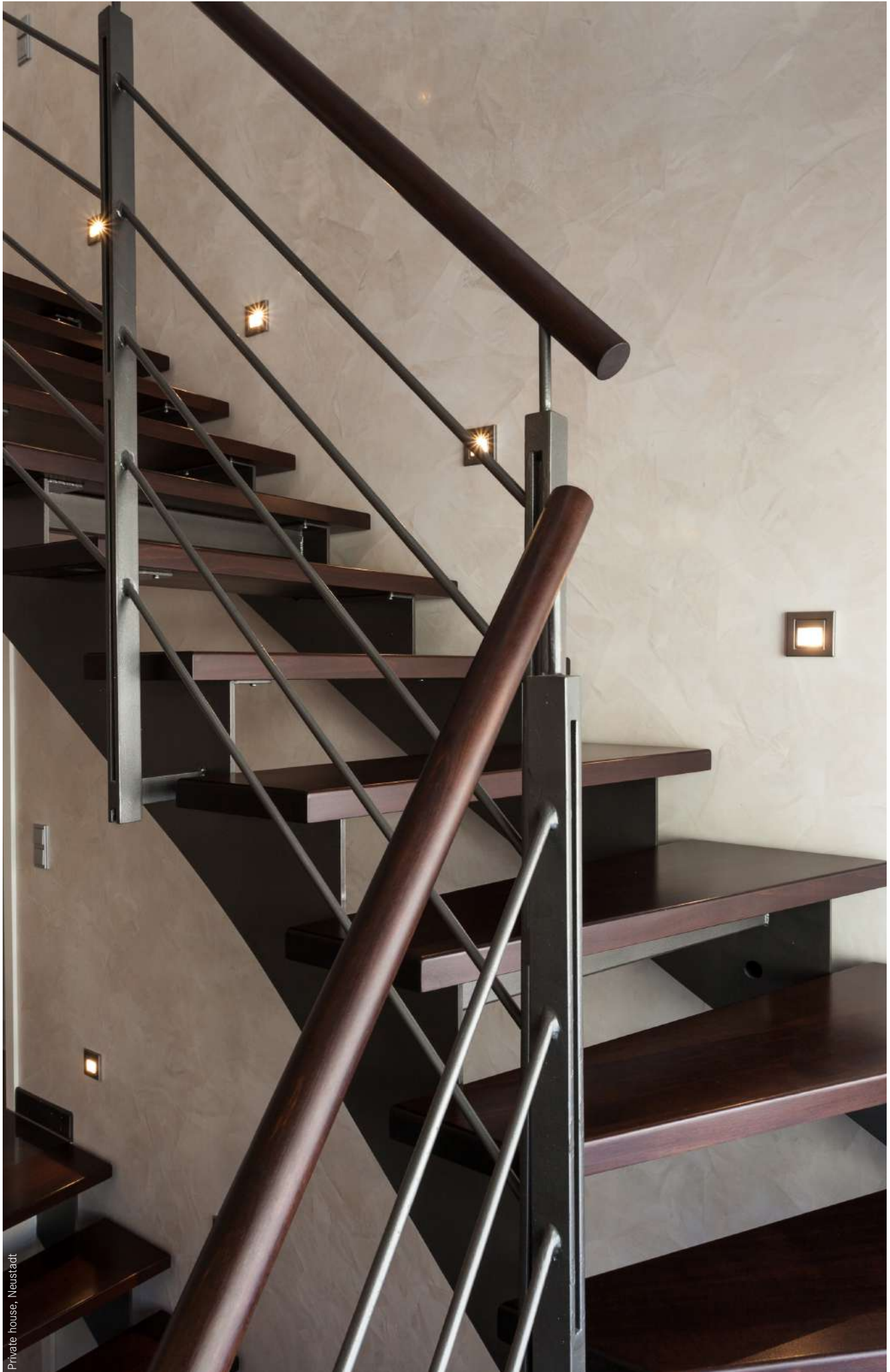

Private house, Neustadt

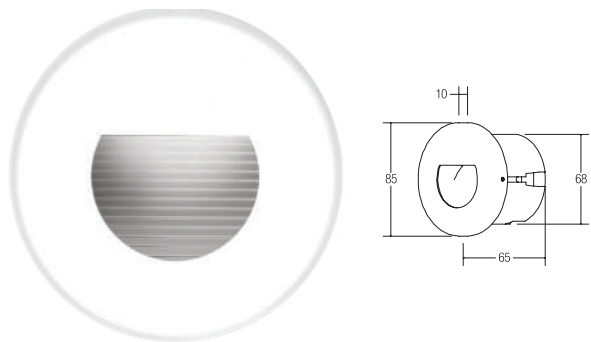

LED wall-mounted recessed luminaire

Including converter for connection with 230 V mains voltage, switchable and hollow wall installation socket Ø DA: 68 mm / installation depth: 65 mm

Illuminants: LED, color rendering: CRI > 80, power: 1.2 W, material: Stainless steel / Aluminum / Plastic

Item no.	Color	Luminous flux	Color temperature	Price €
R3928WW	Structural white	40 lm	3000 K	114.80

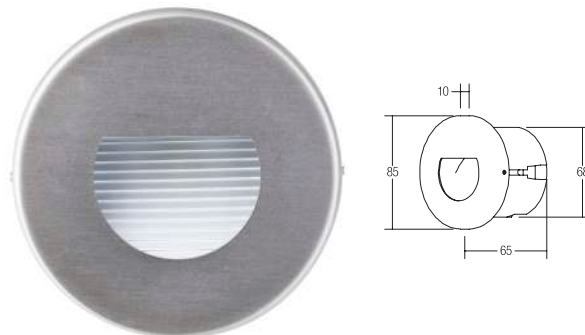

LED wall-mounted recessed luminaire

Including converter for connection with 230 V mains voltage, switchable and hollow wall installation socket Ø DA: 68 mm / installation depth: 65 mm

Illuminants: LED, color rendering: CRI > 80, power: 1.2 W, material: Stainless steel / Aluminum / Plastic

Item no.	Color	Luminous flux	Color temperature	Price €
10128203	Stainless steel	40 lm	3000 K	124.10



LED wall-mounted recessed luminaire

Including converter for connection with 230 V mains voltage, switchable and hollow wall installation socket Ø DA: 68 mm / installation depth: 65 mm

Illuminants: LED, color rendering: CRI > 80, power: 1.2 W, material: Stainless steel / Aluminum / Plastic

Item no.	Color	Luminous flux	Color temperature	Price €
R3929WW	Structural white	40 lm	3000 K	136.80



LED wall-mounted recessed luminaire

Including converter for connection with 230 V mains voltage, switchable and hollow wall installation socket Ø DA: 68 mm / installation depth: 65 mm

Illuminants: LED, color rendering: CRI > 80, power: 1.2 W, material: Stainless steel / Aluminum / Plastic

Item no.	Color	Luminous flux	Color temperature	Price €
10129203	Stainless steel	40 lm	3000 K	147.30



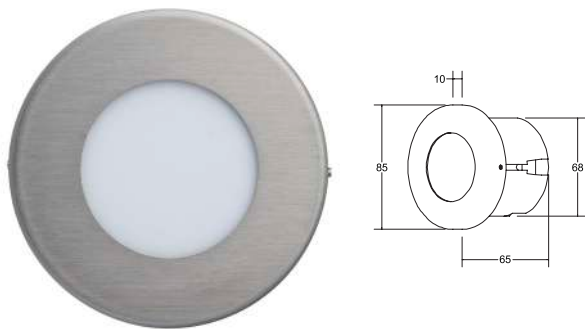

LED wall-mounted recessed luminaire

Including converter for connection with 230 V mains voltage, switchable and hollow wall installation socket Ø 68 mm / installation depth: 65 mm

Illuminants: LED, color rendering: CRI > 80, power: 1.2 W, material: Stainless steel / Acrylic / Plastic

Item no.	Color	Luminous flux	Color temperature	Price €
10141203	Stainless steel	40 lm	3000 K	128.80

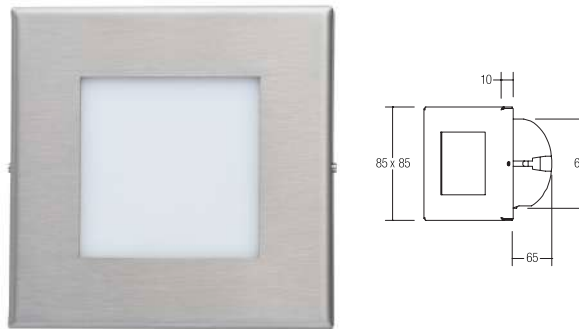

LED wall-mounted recessed luminaire

Including converter for connection with 230 V mains voltage, switchable and hollow wall installation socket Ø 68 mm / installation depth: 65 mm

Illuminants: LED, color rendering: CRI > 80, power: 1.2 W, material: Stainless steel / Acrylic / Plastic

Item no.	Color	Luminous flux	Color temperature	Price €
10140203	Stainless steel	40 lm	3000 K	132.80



LED wall-mounted recessed luminaire

Including converter for connection with 230 V mains voltage, switchable and hollow wall installation socket Ø 68 mm / installation depth: 65 mm

Illuminants: LED, color rendering: CRI > 80, power: 1.2 W, material: Stainless steel / Acrylic / Plastic

Item no.	Color	Luminous flux	Color temperature	Price €
R3941WW	Structural white	40 lm	3000 K	122.20



LED wall-mounted recessed luminaire

Including converter for connection with 230 V mains voltage, switchable and hollow wall installation socket Ø 68 mm / installation depth: 65 mm

Illuminants: LED, color rendering: CRI > 80, power: 1.2 W, material: Stainless steel / Acrylic / Plastic

Item no.	Color	Luminous flux	Color temperature	Price €
R3940WW	Structural white	40 lm	3000 K	122.00



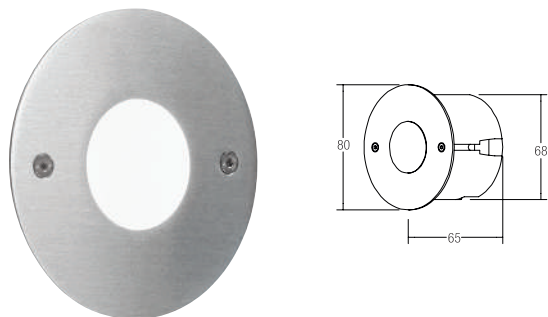

LED wall-mounted recessed luminaire, IP54

Including converter for connection with 230 V mains voltage, switchable and hollow wall installation socket Ø DA: 68 mm / installation depth: 65 mm

Illuminants: LED, color rendering: CRI > 80, power: 1.2 W, material: Stainless steel / Acrylic / Plastic / Silicon rubber

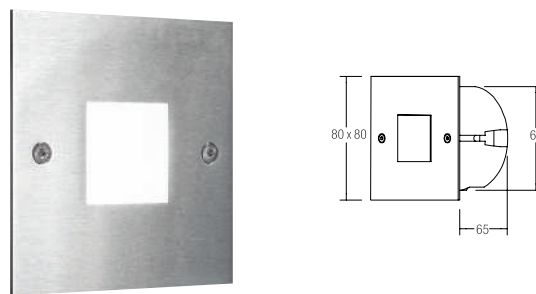

LED wall-mounted recessed luminaire, IP54

Including converter for connection with 230 V mains voltage, switchable and hollow wall installation socket Ø DA: 68 mm / installation depth: 65 mm

Illuminants: LED, color rendering: CRI > 80, power: 1.2 W, material: Stainless steel / Acrylic / Plastic / Silicon rubber

Item no.	Color	Luminous flux	Color temperature	Price €
10012223	Stainless steel	40 lm	3000 K	147.30



* It must be mounted on a leveled surface.

Item no.	Color	Luminous flux	Color temperature	Price €
10011223	Stainless steel	40 lm	3000 K	150.80



* It must be mounted on a leveled surface.

LED wall-mounted recessed luminaire, IP20

Including converter for connection with 230 V mains voltage, switchable and hollow wall installation socket Ø 68 mm / installation depth: 65 mm

Illuminants: LED, color rendering: CRI > 80, power: 1.2 W, material: Stainless steel / Acrylic / Plastic

LED wall-mounted recessed luminaire, IP20

Including converter for connection with 230 V mains voltage, switchable and hollow wall installation socket Ø 68 mm / installation depth: 65 mm

Illuminants: LED, color rendering: CRI > 80, power: 1.2 W, material: Stainless steel / Acrylic / Plastic

Item no.	Color	Luminous flux	Color temperature	Price €
P3937WW	Stainless steel	40 lm	3000 K	125.10



Item no.	Color	Luminous flux	Color temperature	Price €
P3930WW	Stainless steel	40 lm	3000 K	125.90



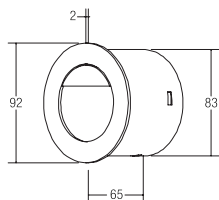

LED wall-mounted recessed luminaire

Delivery including flush-mounted housing, D: 83 mm, ET: 65 mm, for optional installation of individual converter 17666000 (see page 516) inside the housing. The converter 17666000 is not included in the scope of delivery of the luminaire 10165253.

Illuminants: LED, model: Plug&Play, color rendering: CRI > 80, power: 1 W, material: Aluminum / Steel / Glass

You will find the corresponding 350-mA converters from page 516 onwards.

Item no.	Color	Color temperature	Price €
10165253	Aluminum matte	3000 K	89.90

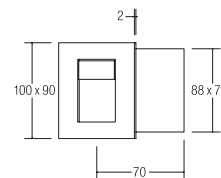
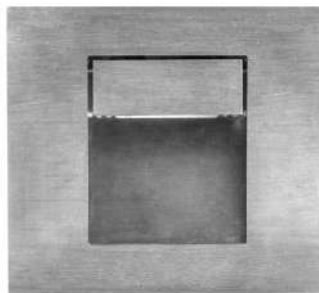

LED wall-mounted recessed luminaire

Delivery including flush-mounted housing, W: 88 mm, H: 79 mm, ET: 70 mm, for optional installation of individual converter 17666000 (see page 516) inside the housing. The converter 17666000 is not included in the scope of delivery of the luminaire 10166223.

Illuminants: LED, model: Plug&Play, color rendering: CRI > 80, power: 1 W, material: Stainless steel / Steel / Glass

You will find the corresponding 350-mA converters from page 516 onwards.

Item no.	Color	Color temperature	Price €
10166223	Stainless steel	3000 K	109.90

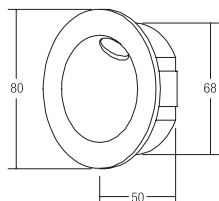

LED wall-mounted recessed luminaire, IP54

For installation in hollow walls using leaf springs. Delivery including flush-mounted housing (W 70 x H 70 x D 50 mm) and decorative panel (100 x 100 mm)

Illuminants: LED, model: Plug&Play, color rendering: CRI > 80, power: 2 W, material: Aluminum / Steel / Glass

You will find the corresponding 700-mA converters from page 524 onwards.

Item no.	Color	Color temperature	Price €
10057173	Structural white	3000 K	139.80

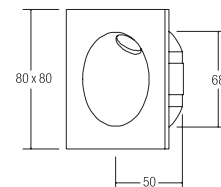

LED wall-mounted recessed luminaire, IP54

For installation in hollow walls using leaf springs. Delivery including flush-mounted housing (W 70 x H 70 x D 50 mm) and decorative panel (100 x 100 mm)

Illuminants: LED, model: Plug&Play, color rendering: CRI > 80, power: 2 W, material: Aluminum / Steel / Glass

You will find the corresponding 700-mA converters from page 524 onwards.

Item no.	Color	Luminous flux	Color temperature	Price €
10058173	Structural white	160 lm	3000 K	143.50



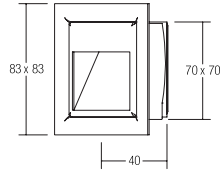

LED wall-mounted recessed luminaire

For installation in hollow walls using leaf springs (optional accessory: Flush-mounted housing 3702, price: gross € 9.70 excluding VAT).

Illuminants: LED, color rendering: CRI > 80, model: Plug&Play, power: 1.2 W, material: Steel / Aluminum

You will find the corresponding 350-mA converters from page 516 onwards.

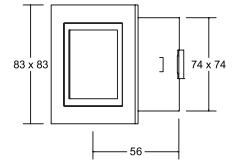

LED wall-mounted recessed luminaire

For installation in hollow walls using leaf springs

Illuminants: LED, color rendering: CRI > 80, model: Plug&Play, power: 1.2 W, material: Cast / Glass

You will find the corresponding 350-mA converters from page 516 onwards.

Item no.	Color	Luminous flux	Color temperature	Price €
P3729WW	Aluminum matte	40 lm	3000 K	62.80



Additionally available: Item no. 3702 flush-mounted housing (72 x 70 mm, ET 54 mm)

Item no.	Color	Luminous flux	Color temperature	Price €
P3730WW	Aluminum matte	40 lm	3000 K	75.90



Private house, Vredem



DEVELOPED BY
INSTA

FEATURED BY
GIRA & JUNG

MEMBER
BRUMBERG

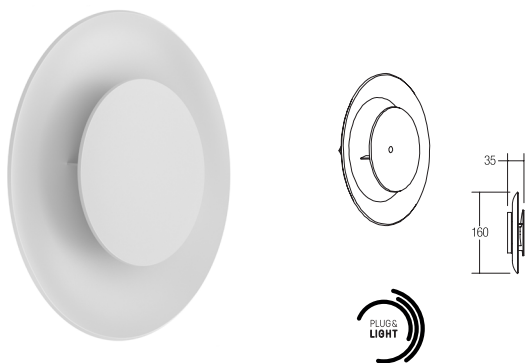

BOWL Plug & Light LED wall surface-mounted luminaire

Attention: only to be used in combination with the Plug & Light system of GIRA and JUNG. Switchable.

Illuminants: LED, color rendering: CRI > 85, power: 3 W, material: Aluminum

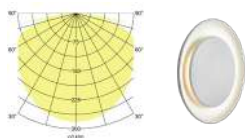

Item no.	Color	Luminous flux	Color temperature	Price €
10707173	Structural white	130 lm	3000 K	199.90

IP20 This item is subject to discount group 2. Design: Alexander Grimm (Lounge Design)

Deliverable accessory: Bracket with magnet for Plug & Light
Item no. 81077000, price €: 10.50 (RG2)

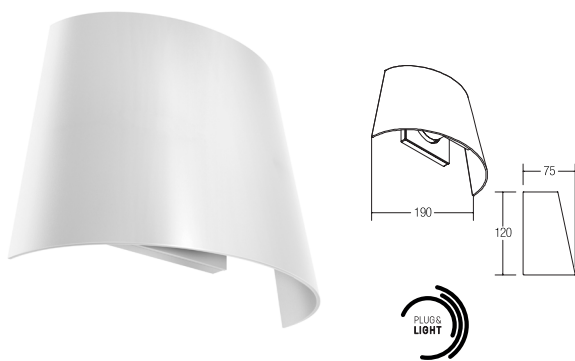

LS CONE Plug & Light LED wall surface-mounted luminaire

Attention: only to be used in combination with the Plug & Light system of GIRA and JUNG. Dimming function can be called via corresponding components from GIRA or JUNG.

Illuminants: LED, color rendering: CRI > 85, power: 8 W, material: Aluminum

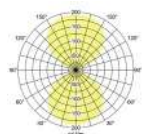

Item no.	Color	Luminous flux	Color temperature	Price €
10720173	Structural white	550 lm	3000 K	254.90

IP20 This item is subject to discount group 2. Design: Alexander Grimm (Lounge Design)

Deliverable accessory: Bracket with magnet for Plug & Light
Item no. 81077000, price €: 10.50 (RG2)

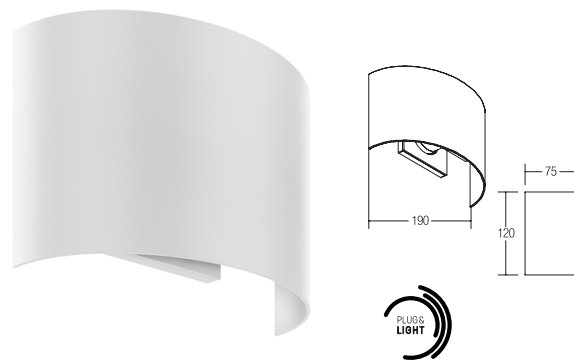

LS STRAIGHT Plug & Light LED wall surface-mounted luminaire

Attention: only to be used in combination with the Plug & Light system of GIRA and JUNG. Dimming function can be called via corresponding components from GIRA or JUNG.

Illuminants: LED, color rendering: CRI > 85, power: 8 W, material: Aluminum

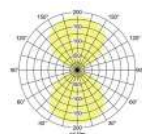

Item no.	Color	Luminous flux	Color temperature	Price €
10721173	Structural white	570 lm	3000 K	254.90

IP20 This item is subject to discount group 2. Design: Alexander Grimm (Lounge Design)

Deliverable accessory: Bracket with magnet for Plug & Light
Item no. 81077000, price €: 10.50 (RG2)



MINIQ Plug & Light LED wall surface-mounted luminaire

Attention: only to be used in combination with the Plug & Light system of GIRA and JUNG. Dimming function can be called via corresponding components from GIRA or JUNG.

Illuminants: LED, color rendering: CRI > 85, power: 4 W, beam angle: 35°, material: Aluminum / Glass

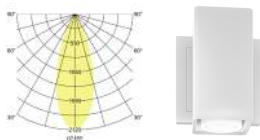

Item no.	Color	Luminous flux	Color temperature	Price €
10701173	Structural white	200 lm	3000 K	229.90

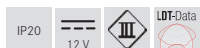

This item is subject to discount group 2.
Design: Alexander Grimm (Lounge Design)

Deliverable accessory: Bracket with magnet for Plug & Light
Item no. 81077000, price €: 10.50 (RG2)



GRAMMO Plug & Light LED wall surface-mounted luminaire

Attention: only to be used in combination with the Plug & Light system of GIRA and JUNG. Dimming function can be called via corresponding components from GIRA or JUNG.

Illuminants: LED, color rendering: CRI > 85, power: 4 W, beam angle: 35°, material: Aluminum / Glass

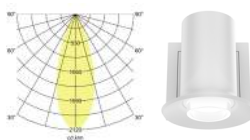

Item no.	Color	Luminous flux	Color temperature	Price €
10703173	Structural white	200 lm	3000 K	254.90

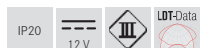

This item is subject to discount group 2.
Design: Alexander Grimm (Lounge Design)

Deliverable accessory: Bracket with magnet for Plug & Light
Item no. 81077000, price €: 10.50 (RG2)





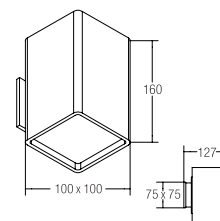
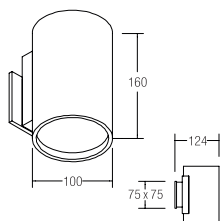

TUBIC LED wall surface-mounted luminaire

LED wall surface-mounted luminaire with 2 x 4.75 W / 2 x 420 lm light emission (Up & Down) and 1.5 W / 130 lm indirect light component.

Illuminants: LED, color rendering: CRI > 90, power: 11 W, beam angle: 40°, material: Aluminum / Glass / Plastic, delivery: including converter for connection with 230 V mains voltage, switchable



QUBIC LED wall surface-mounted luminaire

LED wall surface-mounted luminaire with 2 x 4.75 W / 2 x 420 lm light emission (Up & Down) and 1.5 W / 130 lm indirect light component.

Illuminants: LED, color rendering: CRI > 90, power: 11 W, beam angle: 40°, material: Aluminum / Glass / Plastic, delivery: including converter for connection with 230 V mains voltage, switchable



Item no.	Color	Luminous flux	Color temperature	Price €
10042173	Structural white	970 lm	3000 K	306.20



Design: Alexander Grimm (Lounge Design)
Idea: Michael Ruschmann (Lichtraum Ruschmann Stein GmbH)

Item no.	Color	Luminous flux	Color temperature	Price €
10040173	Structural white	970 lm	3000 K	306.20



Design: Lounge Design (Alexander Grimm and Ronny Eysser (Lounge Design))
Idea: Lichtraum Ruschmann Stein GmbH (Michael Ruschmann)

QUBIC product family



QUBIC LED recessed ceiling luminaire with indirect component
Item no. 12227173
See page 14



QUBIC LED ceiling-mounted recessed spotlight
Item no. 13127173
See page 39

TUBIC product family



TUBIC LED recessed ceiling luminaire with indirect component
Item no. 12226173
See page 14



TUBIC LED ceiling-mounted recessed spotlight
Item no. 13126173
See page 39



QUBIC LED ceiling-mounted luminaire with indirect component
Item no. 12040173
See page 165



TUBIC LED ceiling-mounted luminaire with indirect component
Item no. 12042173
See page 165





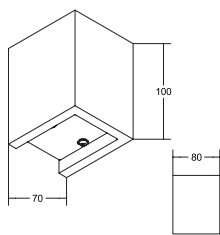

KONKRET LED wall surface-mounted luminaire

Direct light emission.

Illuminants: LED, color rendering: CRI > 80, power: 4.2 W, beam angle: 100°, material: Concrete / Steel / Plastic, delivery: including converter for connection with 230 V mains voltage, switchable

You will find suitable ceiling or pendant-mounted luminaires on pages 14 and 201.

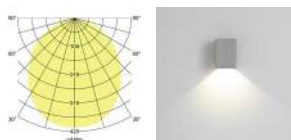

Item no.	Color	Luminous flux	Color temperature	Price €
10100733	Concrete	220 lm	3000 K	74.00

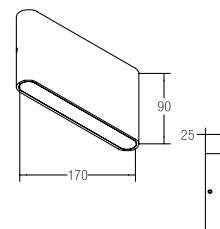
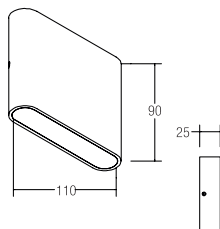

LED wall surface-mounted luminaire, IP54

Direct and indirect light emission.

Illuminants: LED, color rendering: CRI > 80, power: 2 x 3.6 W, beam angle: 120°, luminous flux: 2 x 180 lm, material: Aluminum / Acrylic, delivery: including converter for connection with 230 V mains voltage, switchable

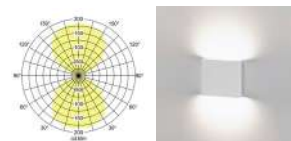

Item no.	Color	Luminous flux	Color temperature	Price €
10045173	Structural white	360 lm	3000 K	197.40
10045253	Aluminum matte	360 lm	3000 K	197.40

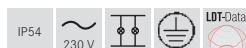

LED wall surface-mounted luminaire, IP54

Direct and indirect light emission.

Illuminants: LED, color rendering: CRI > 80, power: 2 x 5.4 W, beam angle: 120°, luminous flux: 2 x 265 lm, material: Aluminum / Acrylic, delivery: including converter for connection with 230 V mains voltage, switchable

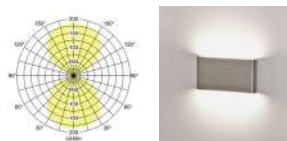

Item no.	Color	Luminous flux	Color temperature	Price €
10046173	Structural white	530 lm	3000 K	219.00
10046253	Aluminum matte	530 lm	3000 K	219.00

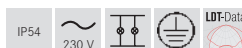



EYE LED wall surface-mounted luminaires, IP65

The Color temperature can be adjusted on site from 3000 K to 4000 K or 5700 K.

Illuminants: LED, color rendering: CRI > 80, power: 12 W, beam angle: 110°, material: Aluminum / plastic, delivery: including converter for connection with 230 V mains voltage, switchable

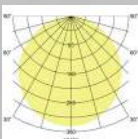
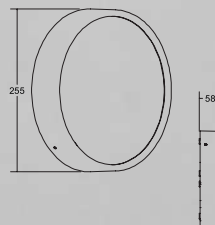

Item no.	Color	Luminous flux	Color temperatures	Price €
10036183	Structural black	1,000 lm	3000 K / 4000 K / 5700 K	111.00



Luminous flux specification for Color temperature



EYE LED wall surface-mounted luminaires, IP65

The Color temperature can be adjusted on site from 3000 K to 4000 K or 5700 K.

Illuminants: LED, color rendering: CRI > 80, power: 12 W, beam angle: 110°, material: Aluminum / plastic, delivery: including converter for connection with 230 V mains voltage, switchable

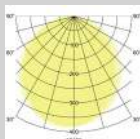
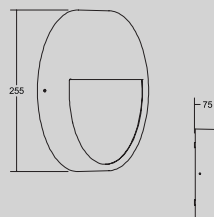

Item no.	Color	Luminous flux	Color temperatures	Price €
10037183	Structural black	880 lm	3000 K / 4000 K / 5700 K	121.50

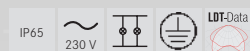

Luminous flux specification for Color temperature



Wall surface-mounted luminaire, IP43

Ceiling or wall surface-mounted luminaires designed as glass luminaires. In timeless, round design, available in various illuminant and power versions. Switchable LED models. Mouth-blown opal glass with glass attachment via bayonet catch.

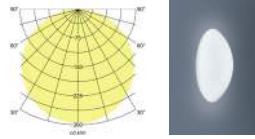

Item no.	Model	Dimensions	Power	Color temperature	Luminous flux	Price €
58272003	LED	D 250 x H 100 mm	11 W	3000 K	1,020 lm	279.90
58274003	LED	D 300 x H 100 mm	15 W	3000 K	1,460 lm	319.90
58276003	LED	D 350 x H 120 mm	25 W	3000 K	2,110 lm	439.90
58278003	LED	D 450 x H 130 mm	29 W	3000 K	2,660 lm	579.90
58280003	LED	D 550 x H 150 mm	29 W	3000 K	2,690 lm	699.90
58271000	E27	D 250 x H 100 mm	1 x maximum 60 W	-		89.90
58273000	E27	D 300 x H 100 mm	2 x maximum 60 W	-		119.90
58275000	E27	D 350 x H 120 mm	3 x maximum 60 W	-		179.90
58277000	E27	D 450 x H 130 mm	3 x maximum 60 W	-		249.90
58279000	E27	D 550 x H 150 mm	3 x maximum 60 W	-		389.90

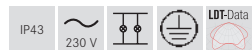

These items are subject to discount group 2.



Wall surface-mounted luminaire, IP43

Ceiling or wall surface-mounted luminaires designed as glass luminaires. In timeless, cylindrical design, available in various illuminant and power versions. Switchable LED models. Mouth-blown opal glass with glass attachment via bayonet catch.

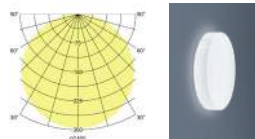

Item no.	Model	Dimensions	Power	Color temperature	Luminous flux	Price €
58292003	LED	D 260 x H 65 mm	11 W	3000 K	940 lm	329.90
58294003	LED	D 310 x H 70 mm	15 W	3000 K	1,330 lm	369.90
58296003	LED	D 400 x H 90 mm	25 W	3000 K	1,950 lm	499.90
58298003	LED	D 450 x H 110 mm	29 W	3000 K	2,620 lm	689.90
58291000	E27	D 260 x H 65 mm	1 x maximum 60 W	-		139.90
58293000	E27	D 310 x H 70 mm	2 x maximum 60 W	-		179.90
58295000	E27	D 400 x H 90 mm	3 x maximum 60 W	-		249.90
58297000	E27	D 450 x H 110 mm	3 x maximum 60 W	-		389.90

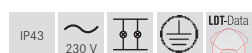

These items are subject to discount group 2.





Wall surface-mounted luminaires, with fabric shade

Wall surface-mounted luminaire with fabric shade, Projection: 360 mm, height: 270 mm, width: 170 mm, swiveling arm, shade material: Chintz, shade color: raw white, surface: nickel matte. Other shade variants can be made available on request.

Model: E27, power: 1 x maximum 60 W

You can find deliverable shade colors and special solutions for each product online in the PDF format on our website.

Item no.	Color	Price €
58171150	Nickel matte / raw white shade	339.90



This item is subject to discount group 2. For suitable table lamps, see page 411 and for suitable floor lamps, see page 413.



Wall surface-mounted luminaires, with fabric shade

Wall surface-mounted luminaire with fabric shade, Projection: 150 mm, height: 450 mm, width: 200 mm, shade material: Chintz, shade color: raw white, surface: nickel matte. With additional 3-W LED reading lamp (on-site switch). Other shade variants can be made available on request.

Model: E27, power: 1 x maximum 60 W

You can find deliverable shade colors and special solutions for each product online in the PDF format on our website.

Item no.	Color	Price €
58173150	Nickel matte / raw white shade	519.90



This item is subject to discount group 2. For suitable table lamps, see page 411 and for suitable floor lamps, see page 413.



Wall surface-mounted luminaires, with fabric shade

Wall surface-mounted luminaire with fabric shade, Projection: 150 mm, height: 300 mm, width: 200 mm, shade material: Chintz, shade color: raw white, surface: nickel matte. Other shade variants can be made available on request.

Model: E27, power: 1 x maximum 60 W

You can find deliverable shade colors and special solutions for each product online in the PDF format on our website.

Item no.	Color	Price €
58172150	Nickel matte / raw white shade	269.90



This item is subject to discount group 2. For suitable table lamps, see page 411 and for suitable floor lamps, see page 413.



Wall surface-mounted luminaires, with fabric shade

Wall surface-mounted luminaire with fabric shade, head swivels 180°, Shade material: Chintz; shade color: black.
Surface: black powdered, diameter: 140 mm
Height: 170 mm, projection: 250 mm
Other shade variants can be made available on request.

Model: G9, power: 1 x maximum 48 W

You can find deliverable shade colors and special solutions for each product online in the PDF format on our website.

Item no.	Color	Price €
58151080	Black/black shade	359.90



This item is subject to discount group 2.
For suitable table lamps, see page 410
and for suitable floor lamps, see page 413.



Wall surface-mounted luminaires, with fabric shade

Wall surface-mounted luminaire with fabric shade, head swivels 180°, Shade material: Chintz; shade color: black.
Surface: black powdered, diameter: 140 mm
Height: 170 mm, projection: 420 mm, flexible arm length: 250 mm
Other shade variants can be made available on request.

Model: G9, power: 1 x maximum 48 W

You can find deliverable shade colors and special solutions for each product online in the PDF format on our website.

Item no.	Color	Price €
58152080	Black/black shade	389.90



This item is subject to discount group 2.
For suitable table lamps, see page 410
and for suitable floor lamps, see page 413.



Wall surface-mounted luminaires, with fabric shade

Wall surface-mounted luminaire with fabric shade, head swivels 180°, Shade material: Chintz; shade color: black.
Surface: black powdered, diameter: 140 mm
Height: 170 mm, projection: 410 mm
Other shade variants can be made available on request.

Model: G9, power: 1 x maximum 48 W

You can find deliverable shade colors and special solutions for each product online in the PDF format on our website.

Item no.	Color	Price €
58153080	Black/black shade	419.90



This item is subject to discount group 2.
For suitable table lamps, see page 410
and for suitable floor lamps, see page 413.



Wall surface-mounted luminaires, with fabric shade

Wall surface-mounted luminaire with fabric shade, head swivels 180° and additional, flexibly adjustable 3-W LED reading lamp (on-site switch).
Shade material: Chintz; shade color: black.
Surface: black powdered, diameter: 140 mm
Height: 200 mm, projection: 220 mm
Other shade variants can be made available on request.

Model: G9, power: 1 x maximum 48 W

You can find deliverable shade colors and special solutions for each product online in the PDF format on our website.

Item no.	Color	Price €
58154080	Black/black shade	479.90



This item is subject to discount group 2.
For suitable table lamps, see page 410
and for suitable floor lamps, see page 413.



Wall surface-mounted luminaires, with fabric shade

Wall surface-mounted luminaire with fabric shade,
Projection: 400 mm, height: 280 mm, width: 250 mm
Shade material: Chintz; shade color: black, surface: chromium
Other shade variants can be made available on request.

Model: E27, power: 1 x maximum 60 W

You can find deliverable shade colors and special solutions for each product online in the PDF format on our website.

Item no.	Color	Price €
58111020	Chromium/black shade	369.90



This item is subject to discount group 2.
For suitable table lamps, see page 410
and for suitable floor lamps, see page 413.



Wall surface-mounted luminaires, with fabric shade

Wall surface-mounted luminaire with fabric shade,
Projection: 170 mm, height: 280 mm, width: 320 mm
Shade material: Chintz; shade color: black, surface: chromium
Other shade variants can be made available on request.

Model: E27, power: 1 x maximum 60 W

You can find deliverable shade colors and special solutions for each product online in the PDF format on our website.

Item no.	Color	Price €
58112020	Chromium/black shade	269.90



This item is subject to discount group 2.
For suitable table lamps, see page 410
and for suitable floor lamps, see page 413.



Wall surface-mounted luminaires, with fabric shade

Wall surface-mounted luminaire with fabric shade, head swivels 180°, shade material: Chintz, shade color: brown, surface: nickel matte, height: 170 mm, width: 160 mm, projection: 290 mm
Other shade variants can be made available on request.

Model: G9, power: 1 x maximum 48 W

You can find deliverable shade colors and special solutions for each product online in the PDF format on our website.

Item no.	Color	Price €
58131150	Nickel matte / brown shade	419.90



This item is subject to discount group 2.
For suitable table lamps, see page 410
and for suitable floor lamps, see page 413.



Wall surface-mounted luminaires, with fabric shade

Wall surface-mounted luminaire with fabric shade and flexible arm, shade material: Chintz, shade color: brown, surface: nickel matte, height: 170 mm, width: 160 mm, projection: 460 mm
Other shade variants can be made available on request.

Model: G9, power: 1 x maximum 48 W

You can find deliverable shade colors and special solutions for each product online in the PDF format on our website.

Item no.	Color	Price €
58132150	Nickel matte / brown shade	449.90



This item is subject to discount group 2.
For suitable table lamps, see page 410
and for suitable floor lamps, see page 413.



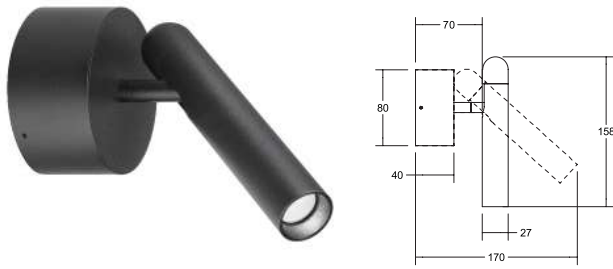

CUBA LED surface-mounted spotlight, rotatable and swiveling

NEW

Illuminants: LED, color rendering: CRI > 90, power: 4.2 W, beam angle: 38°, material: Aluminum, delivery: including converter for connection with 230 V mains voltage, switchable

Item no.	Color	Luminous flux	Color temperature	Price €
10122173	NEW Structural white	220 lm	3000 K	135.60
10122183	NEW Structural black	220 lm	3000 K	135.60



CUBA product family

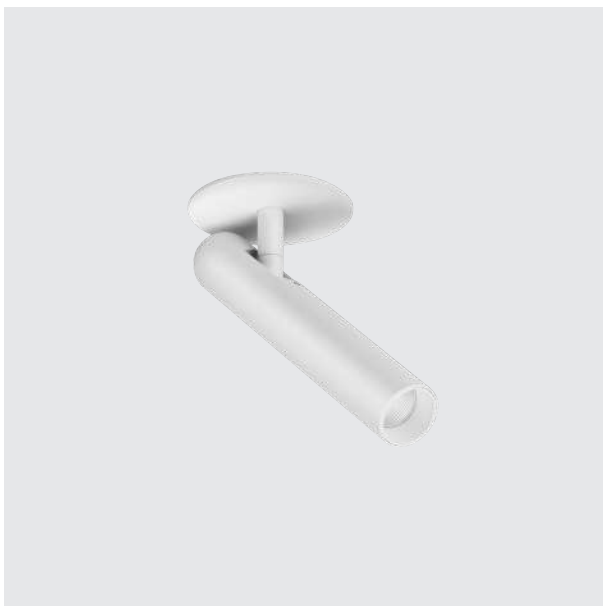

CUBA LED ceiling-mounted recessed spotlight
See page 78

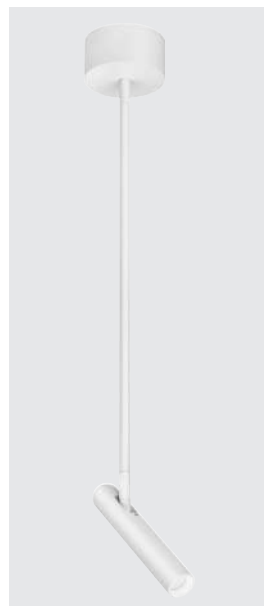

CUBA LED surface-mounted spotlight
See page 179



CUBA LED pendant luminaire
See page 198

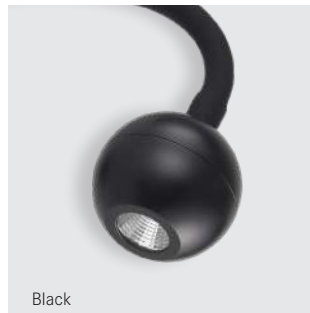
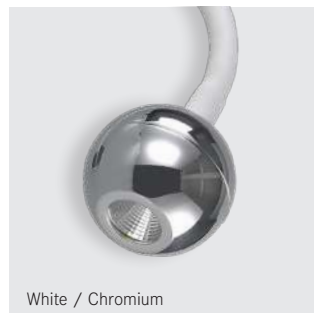
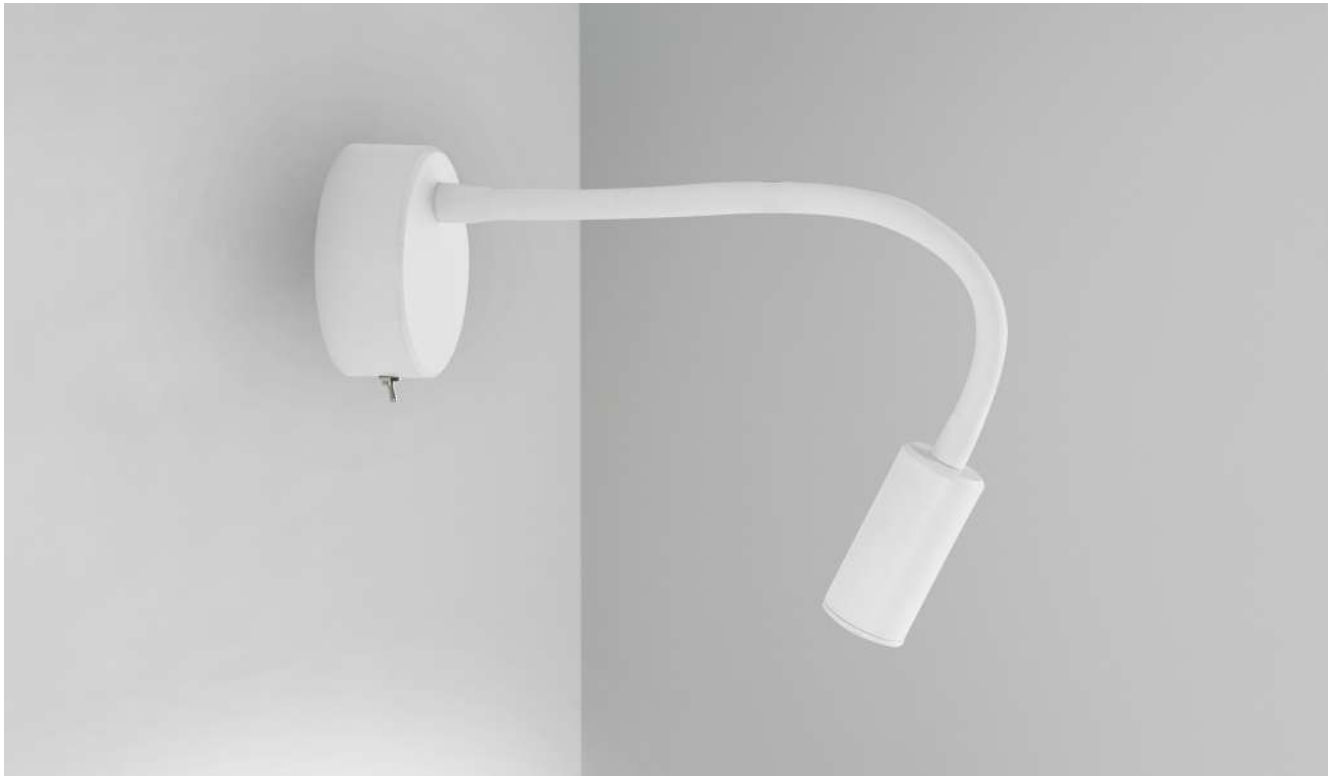

ARCUS.

Easy to adjust thanks to the flexible arm.

The ARCUS as a surface-mounted or recessed variant is ideally suited as a bed or reading lamp. The flexible positioning of the luminaire head enables targeted illumination. It can be used in many room concepts with different requirements for mounting and design.

The luminaire is available in 16 color combinations from the surfaces white, black and chromium.

To the product.



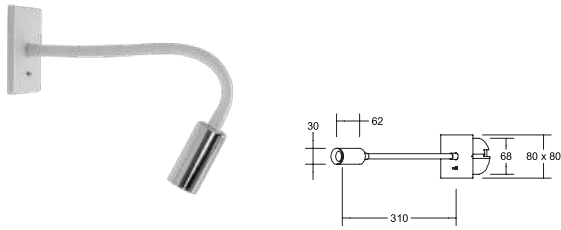

ARCUS LED recessed reading lamps, for device sockets, with cylinder head

NEW

For installation in hollow wall or concrete device sockets with an installation depth of at least 62 mm (screw spacing: 60 mm).

Compatible with Kaiser device sockets for installation in hollow wall, item no. 9064-02 or 9464-02, or installation in concrete, item no. 1556-04. Caution: The delivery is WITHOUT the device socket.

Including integrated On/Off switch, for hollow wall mounting socket \varnothing DA: 68 mm / installation depth: 65 mm, outer dimensions 80 x 80 mm, flexible arm length: 250 mm, cylinder diameter: 30 mm

Illuminants: LED, color rendering: CRI > 80, power: 4.2 W, beam angle: 41°, material: Aluminum / Steel, delivery: including converter for connection with 230 V mains voltage, switchable

Item no.	Color	Luminous flux	Color temperature	Price €
10180073	NEW White	290 lm	3000 K	105.00
10180723	NEW White / chrome luminaire head	290 lm	3000 K	115.60
10180083	NEW Black	290 lm	3000 K	105.00
10180823	NEW Black / chrome luminaire head	290 lm	3000 K	115.60

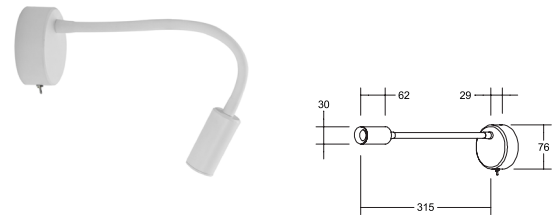

ARCUS LED surface-mounted reading lamp, with cylinder head

NEW

Including integrated On/Off switch, Dimensions of surface-mounted housing: Diameter 76 mm, height 29 mm, Flexible arm length: 250 mm, cylinder diameter: 30 mm

Illuminants: LED, color rendering: CRI > 80, power: 4.2 W, beam angle: 41°, material: Aluminum / Steel, delivery: including converter for connection with 230 V mains voltage, switchable

Item no.	Color	Luminous flux	Color temperature	Price €
10190073	NEW White	290 lm	3000 K	136.80
10190723	NEW White / chrome luminaire head	290 lm	3000 K	147.40
10190083	NEW Black	290 lm	3000 K	136.80
10190823	NEW Black / chrome luminaire head	290 lm	3000 K	147.40





Country inn, Sundern

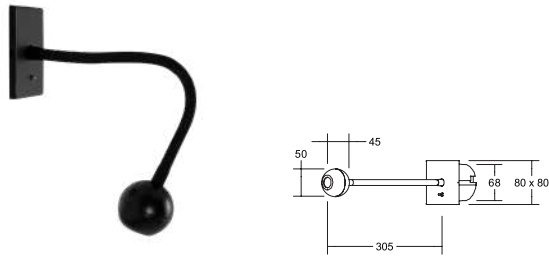

ARCUS LED recessed reading lamps, for device sockets, with spherical head

NEW

For installation in hollow wall or concrete device sockets with an installation depth of at least 62 mm (screw spacing: 60 mm).

Compatible with Kaiser device sockets for installation in hollow wall, item no. 9064-02 or 9464-02, or installation in concrete, item no. 1556-04. Caution: The delivery is WITHOUT the device socket.

Including integrated On/Off switch, for hollow wall mounting socket \varnothing DA: 68 mm / installation depth: 65 mm, outer dimensions 80 x 80 mm, flexible arm length: 250 mm, sphere diameter: 50 mm

Illuminants: LED, color rendering: CRI > 80, power: 4.2 W, beam angle: 44°, material: Aluminum / Steel, delivery: including converter for connection with 230 V mains voltage, switchable

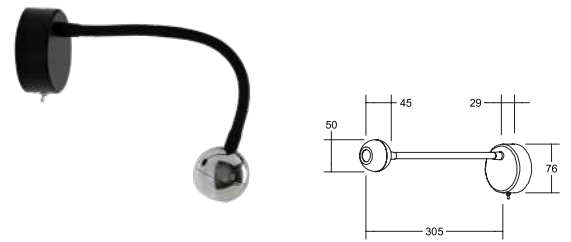

ARCUS LED surface-mounted reading lamp, with spherical head

NEW

Including integrated On/Off switch, dimensions
Surface-mounted housing: Diameter 76 mm, height 29 mm,
Flexible arm length: 250 mm, sphere diameter: 50 mm

Illuminants: LED, color rendering: CRI > 80, power: 4.2 W, beam angle: 44°, material: Aluminum / Steel, delivery: including converter for connection with 230 V mains voltage, switchable

Item no.	Color	Luminous flux	Color temperature	Price €
10181073	NEW White	320 lm	3000 K	105.00
10181723	NEW White / chrome luminaire head	320 lm	3000 K	115.60
10181083	NEW Black	320 lm	3000 K	105.00
10181823	NEW Black / chrome luminaire head	320 lm	3000 K	115.60



Item no.	Color	Luminous flux	Color temperature	Price €
10191073	NEW White	320 lm	3000 K	136.80
10191723	NEW White / chrome luminaire head	320 lm	3000 K	147.40
10191083	NEW Black	320 lm	3000 K	136.80
10191823	NEW Black / chrome luminaire head	320 lm	3000 K	147.40



1

Interior lighting



04

Mirror luminaires.

The fixed point in every bathroom.

Mirror luminaires

Page 244



Private house, Norderstedt



MIRROR LED wall mounted & mirror luminaires, IP44

LED mirror luminaire with edge lighting on both sides.

Illuminants: LED, color rendering: CRI > 90, power: 2 x 12 W, luminous flux: 2 x 1,238 lm, material: Crystal mirror glass / Aluminum, dimensions: H 600 x B 600 x D 30 mm

Item no.	Luminous flux	Color temperature	Price in €
58321003	2,476 lm	3000 K	822.00

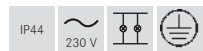

This item is subject to discount group 2.



MIRROR LED wall mounted & mirror luminaires, IP44

LED mirror luminaire with edge lighting on one side.

Illuminants: LED, color rendering: CRI > 90, power: 17 W, material: Crystal mirror glass / Aluminum, dimensions: H 800 x B 500 x D 30 mm

Item no.	Luminous flux	Color temperature	Price in €
58311003	1,788 lm	3000 K	644.00



This item is subject to discount group 2.



MIRROR LED wall mounted & mirror luminaires, IP44

LED mirror luminaire with edge lighting on both sides.

Illuminants: LED, color rendering: CRI > 90, power: 2 x 17 W, luminous flux: 2 x 1,788 lm, material: Crystal mirror glass / aluminum, dimensions: H 800 x B 600 x T 30 mm

Item no.	Luminous flux	Color temperature	Price in €
58322003	3,576 lm	3000 K	959.00



This item is subject to discount group 2.



MIRROR LED wall mounted & mirror luminaires, IP44

LED mirror luminaire with edge lighting on both sides.

Illuminants: LED, color rendering: CRI > 90, power: 2 x 14 W, luminous flux: 2 x 1,512 lm, material: Crystal mirror glass / aluminum, dimensions: H 600 x B 800 x T 30 mm

Item no.	Luminous flux	Color temperature	Price in €
58301003	3,024 lm	3000 K	849.00



This item is subject to discount group 2.

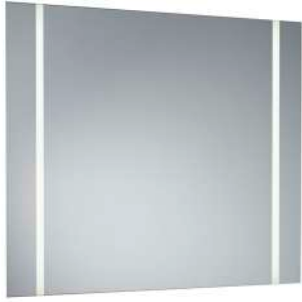

MIRROR LED wall mounted & mirror luminaires, IP44

LED mirror luminaire with edge lighting on both sides.

Illuminants: LED, color rendering: CRI > 90, power: 2 x 20 W, luminous flux: 2 x 2,062 lm, material: Crystal mirror glass / aluminum, dimensions: H 800 x B 800 x T 30 mm

Item no.	Luminous flux	Color temperature	Price in €
58302003	4,124 lm	3000 K	1,079.00

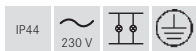

This item is subject to discount group 2.

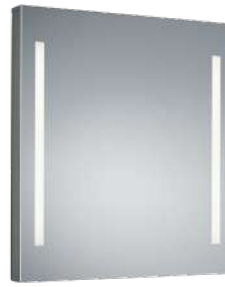

MIRROR LED wall mounted & mirror luminaires, IP44

LED mirror luminaire with edge lighting on both sides.

Illuminants: LED, color rendering: CRI > 90, power: 2 x 17 W, luminous flux: 2 x 1,788 lm, material: Crystal mirror glass / aluminum, dimensions: H 800 x B 800 x T 30 mm

Item no.	Luminous flux	Color temperature	Price in €
58323003	3,576 lm	3000 K	999.00



This item is subject to discount group 2.



MIRROR LED wall mounted & mirror luminaires, IP44

LED mirror luminaire with edge lighting on one side.

Illuminants: LED, color rendering: CRI > 90, power: 17 W, material: Crystal mirror glass / Aluminum, dimensions: H 1,000 x B 500 x D 30 mm

Item no.	Luminous flux	Color temperature	Price in €
58312003	2,338 lm	3000 K	749.00



This item is subject to discount group 2.

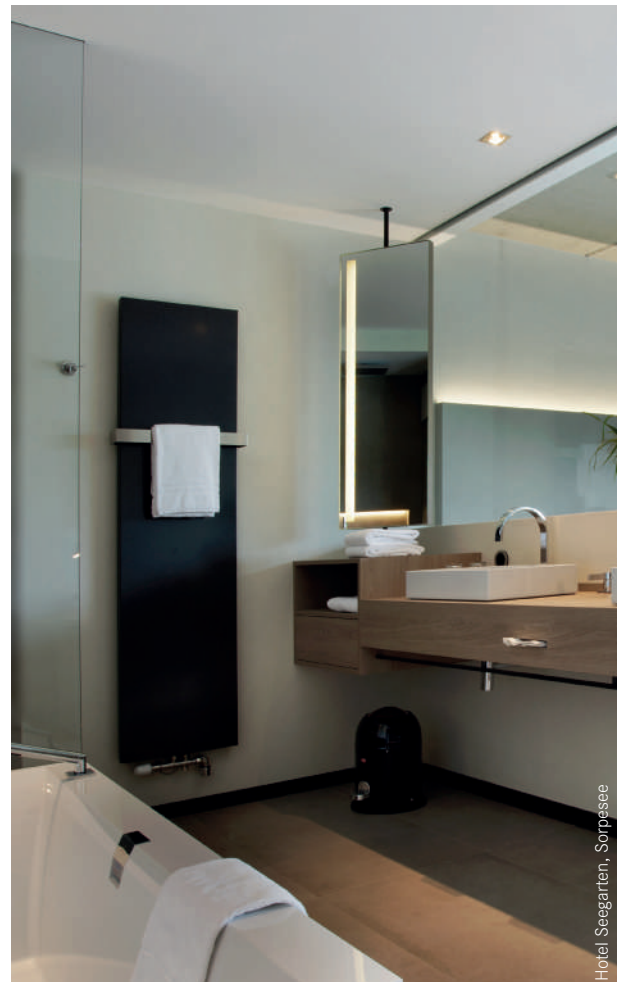

1

Interior lighting



05 Track spotlights. Perfectly staged retail areas.

Track spotlights
Busbars

Page 248
Page 254

Accessories

Page 255



Kotte, Dortmund



LED track spotlight

Including operating device, switchable.
Luminaires with Euro adapter for standard 3-phase rails,
Passive heat dissipation (without fans), weight: 0.5 kg

Illuminants: LED, color rendering: CRI > 80, power: 12 W,
beam angle: 38°, material: Aluminum / Plastic

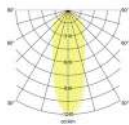

Item no.	Color	Color temperature	Luminous flux	Price €
12013073	White	3000 K	840 lm	129.90
12013083	Black	3000 K	840 lm	129.90



LED track spotlight

Including operating device, switchable.
Luminaires with Euro adapter for standard 3-phase rails,
Passive heat dissipation (without fans), weight: 0.65 kg

Illuminants: LED, color rendering: CRI > 80, power: 12 W,
beam angle: 38°, material: Aluminum / Plastic

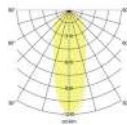

Item no.	Color	Color temperature	Luminous flux	Price €
12019073	White	3000 K	840 lm	149.90
12019083	Black	3000 K	840 lm	149.90



Car dealership, Amsberg

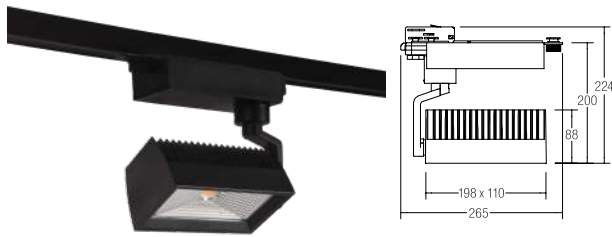

CORE LED track spotlight Wallwasher

Including light source: 1 x LED COB, system power: 45 W,
Passive heat dissipation (without fans), beam characteristics:
Wide flood, rotation angle: rotatable/swiveling, lights including
Euro-adapter for standard 3-phase rails, including operating device,
switchable, power factor > 0.9 (230 V AC 50 Hz), weight 2.3 kg

Illuminants: LED, color rendering: CRI > 80, beam angle: 100°,
material: Aluminum / Glass

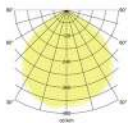

CORE LED recessed spotlights Wallwasher

Item no. 88687 ...

See page 85

Item no.	Color	Color temperature	Luminous flux	Beam angle	Price €
88387173	White	3000 K	3,980 lm	100°	199.00
88387175	White	3500 K	4,120 lm	100°	199.00
88387174	White	4000 K	4,470 lm	100°	199.00
88387183	Black	3000 K	3,980 lm	100°	199.00
88387185	Black	3500 K	4,120 lm	100°	199.00
88387184	Black	4000 K	4,470 lm	100°	199.00



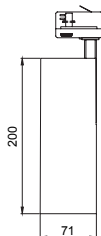

MINI LED track spotlight

NEW

Illuminants: LED, input voltage: 220-240 V AC, 50-60 Hz, power: 23 W, beam angle: 36° (24° on request), Material: Aluminum, delivery: including operating device, switchable

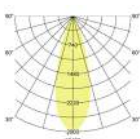

- Suitable for different 3-phase busbars
- Ballast included in tube, no VG on busbar
- Optional accessory: Glare shield, honeycomb grid or shade
- Rotatable (350°) and swiveling
- 2 emission angles 24° and 36°
- Concealed swivel joint, spotlight can be used pointing down as downlight
- Operating efficiency 121 lm/W

Item no.	Color	Luminous flux	Color temperature	Color rendering	Price in €
88393173	NEW Structural white	2,290 lm	3000 K	CRI > 90	139.00
88393175	NEW Structural white	2,355 lm	3500 K	CRI > 90	139.00
88393174	NEW Structural white	2,425 lm	4000 K	CRI > 90	139.00
88393183	NEW Structural black	2,290 lm	3000 K	CRI > 90	139.00
88393185	NEW Structural black	2,355 lm	3500 K	CRI > 90	139.00
88393184	NEW Structural black	2,425 lm	4000 K	CRI > 90	139.00
88393683	NEW Structural silver	2,290 lm	3000 K	CRI > 90	139.00
88393685	NEW Structural silver	2,355 lm	3500 K	CRI > 90	139.00
88393684	NEW Structural silver	2,425 lm	4000 K	CRI > 90	139.00



Accessories upon request:



Glare shield



Shade



Honeycomb grid

Description	Item no.	Color	Price in €
Glare shield	81393170	NEW Structural white	26.40
	81393180	NEW Structural black	26.40
	81393680	NEW Structural silver	26.40
Shade	81393171	NEW Structural white	24.30
	81393181	NEW Structural black	24.30
	81393681	NEW Structural silver	24.30
Honeycomb grid	81393182	NEW Black	15.10

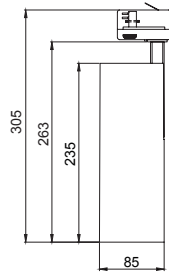

MAXI LED track spotlight

NEW

Illuminants: LED, input voltage: 220-240 V AC, 50-60 Hz, power: 32 W, beam angle: 30° (20° on request), Material: Aluminum, delivery: including operating device, switchable

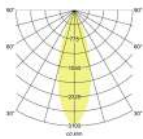

- Suitable for different 3-phase busbars
- Ballast included in tube, no VG on busbar
- Optional accessory: Glare shield, honeycomb grid or shade
- Rotatable (350°) and swiveling
- 2 emission angles 20° and 30°
- Concealed swivel joint, spotlight can be used pointing down as downlight
- Operating efficiency 121 lm/W

Item no.	Color	Luminous flux	Color temperature	Color rendering	Price in €
88397173 NEW	Structural white	3,200 lm	3000 K	CRI > 90	149.00
88397175 NEW	Structural white	3,295 lm	3500 K	CRI > 90	149.00
88397174 NEW	Structural white	3,390 lm	4000 K	CRI > 90	149.00
88397183 NEW	Structural black	3,200 lm	3000 K	CRI > 90	149.00
88397185 NEW	Structural black	3,295 lm	3500 K	CRI > 90	149.00
88397184 NEW	Structural black	3,390 lm	4000 K	CRI > 90	149.00
88397683 NEW	Structural silver	3,200 lm	3000 K	CRI > 90	149.00
88397685 NEW	Structural silver	3,295 lm	3500 K	CRI > 90	149.00
88397684 NEW	Structural silver	3,390 lm	4000 K	CRI > 90	149.00



Accessories upon request:



Glare shield



Shade



Honeycomb grid

Description	Item no.	Color	Price in €
Glare shield	81397170 NEW	Structural white	29.60
	81397180 NEW	Structural black	29.60
	81397680 NEW	Structural silver	29.60
Shade	81397171 NEW	Structural white	26.40
	81397181 NEW	Structural black	26.40
	81397681 NEW	Structural silver	26.40
Honeycomb grid	81397182 NEW	Black	17.20

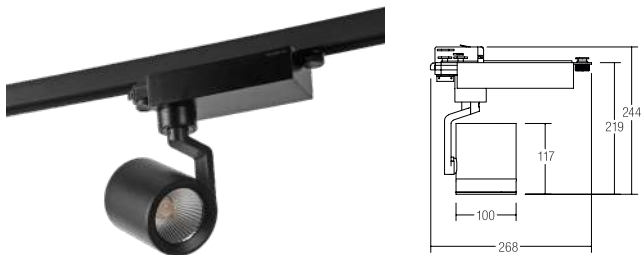

CORE LED track spotlight

Rotation angle: rotatable/swiveling, dimensions of luminaire: Ø 100 mm x 245 mm, including operating device, switchable, power factor > 0.9 (230 V AC 50 Hz).

Lights including Euro adapter for standard 3-phase rails.

Illuminants: LED, color rendering: CRI > 80, power: 32 W, beam angle: 36°, material: Aluminum / Glass / Plastic

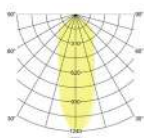

CORE LED recessed spotlight

Item no. 88673 ...

See page 80

- Suitable for different 3-phase busbars
- Rotatable and swiveling (355° / 180°)
- Protective glass for LED illuminant
- Modular assembly for easy reflector replacement
- Emission angle from 12° to 60° using optional reflectors

Item no.	Color	Luminous flux	Color temperature	Beam angle*	Price in €
88373173	White	2,687 lm	3000 K	36°	189.00
88373175	White	2,724 lm	3500 K	36°	189.00
88373174	White	2,762 lm	4000 K	36°	189.00
88373183	Black	2,687 lm	3000 K	36°	189.00
88373185	Black	2,724 lm	3500 K	36°	189.00
88373184	Black	2,762 lm	4000 K	36°	189.00



* Also available with beam angle 12°, 24° or 60° on request.



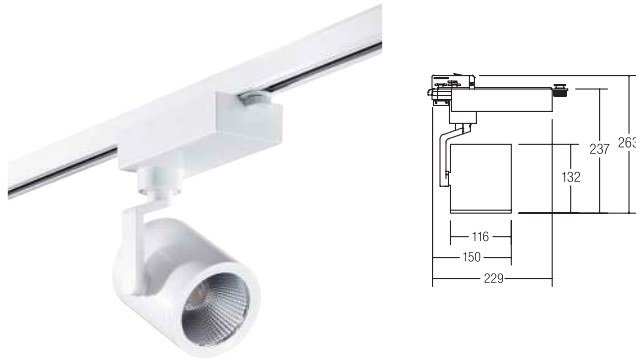

CORE LED track spotlight

Rotation angle: rotatable/swiveling, dimensions of luminaire: Ø 116 mm x 237 mm, including operating device, switchable, power factor > 0.9 (230 V AC 50 Hz).

Lights including Euro adapter for standard 3-phase rails.

Illuminants: LED, color rendering: CRI > 80, power: 45 W, beam angle: 38°, material: Aluminum / Glass / Plastic

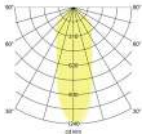

CORE LED recessed spotlight

Item no. 88677 ...

See page 81

- Suitable for different 3-phase busbars
- Rotatable and swiveling (355° / 180°)
- Protective glass for LED illuminant
- Modular assembly for easy reflector replacement
- Emission angle from 12° to 60° using optional reflectors

Item no.	Color	Luminous flux	Color temperature	Beam angle*	Price in €
88377173	White	3,803 lm	3000 K	38°	229.00
88377175	White	3,917 lm	3500 K	38°	229.00
88377174	White	4,030 lm	4000 K	38°	229.00
88377183	Black	3,803 lm	3000 K	38°	229.00
88377185	Black	3,917 lm	3500 K	38°	229.00
88377184	Black	4,030 lm	4000 K	38°	229.00



* Also available with beam angle 12°, 24° or 60° on request.



3-phase busbars

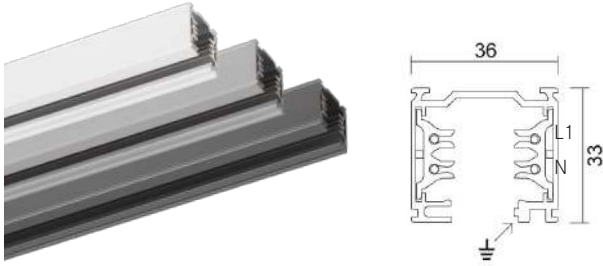

1-phase busbars DALI

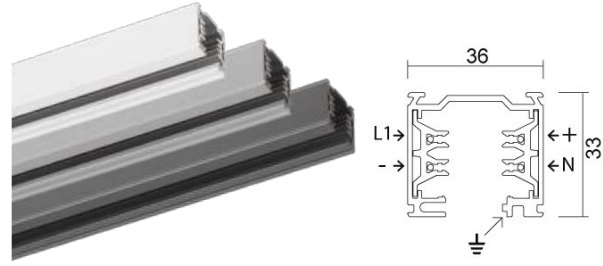

3-phase busbars

Item no.	Length	Color	Price in €
88101070	1,000 mm	White	37.10
88101080	1,000 mm	Black	37.10
88101250	1,000 mm	Aluminum anodized	37.10
88102070	2,000 mm	White	70.80
88102080	2,000 mm	Black	70.80
88102250	2,000 mm	Aluminum anodized	70.80
88103070	3,000 mm	White	102.70
88103080	3,000 mm	Black	102.70
88103250	3,000 mm	Aluminum anodized	102.70
88104070	4,000 mm	White	136.40
88104080	4,000 mm	Black	136.40
88104250	4,000 mm	Aluminum anodized	136.40

1-phase busbars DALI

Item no.	Length	Color	Price in €
88161070	1,000 mm	White	54.00
88161080	1,000 mm	Black	54.00
88161250	1,000 mm	Aluminum anodized	54.00
88162070	2,000 mm	White	97.50
88162080	2,000 mm	Black	97.50
88162250	2,000 mm	Aluminum anodized	97.50
88163070	3,000 mm	White	145.10
88163080	3,000 mm	Black	145.10
88163250	3,000 mm	Aluminum anodized	145.10
88164070	4,000 mm	White	194.80
88164080	4,000 mm	Black	194.80
88164250	4,000 mm	Aluminum anodized	194.80

Matching DALI-track spotlight on request.

DALI-compatibility: It is mandatory to use the track spotlight and the track system from Brumberg!

Planning aid, top view:

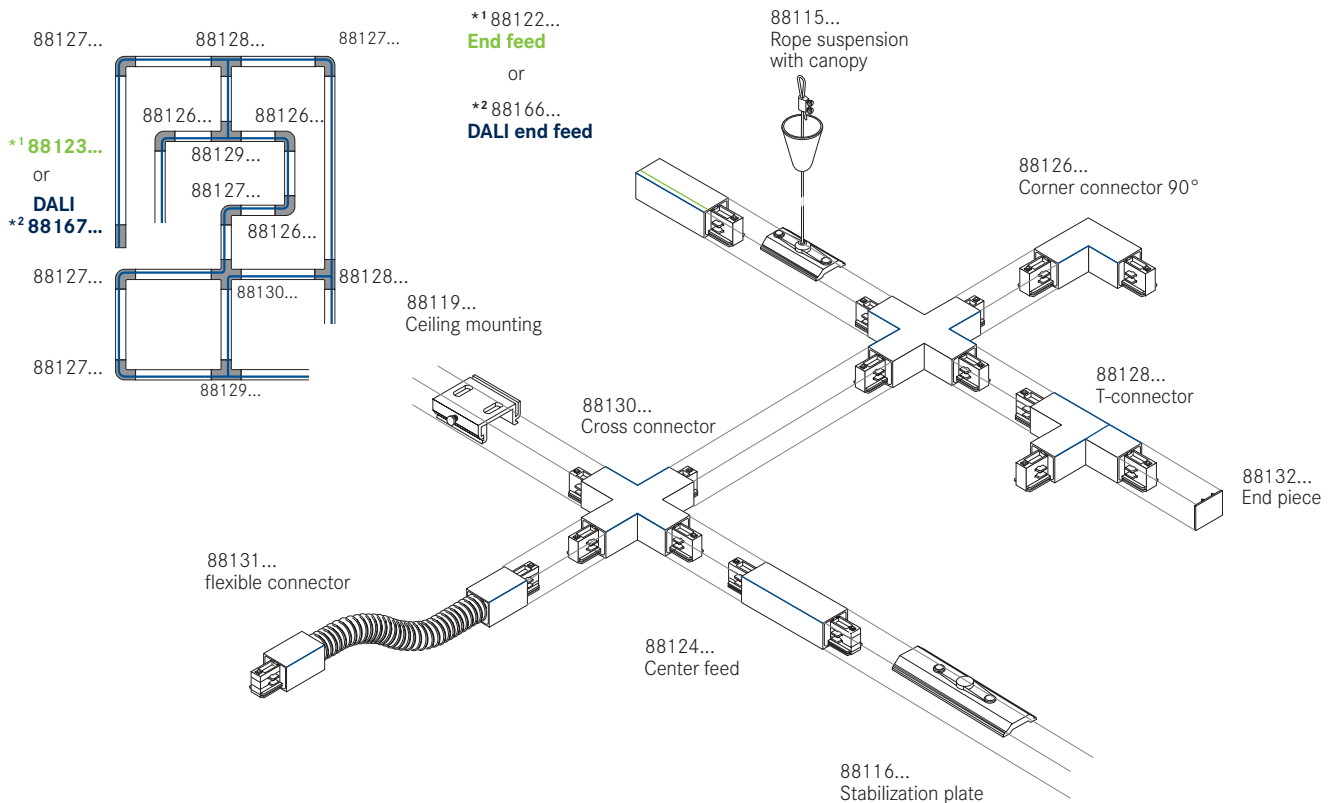

***1 End feed, protective conductor left for 3-phase tracks**



Item no.	Color	Price in €
88123070	White	16.70
88123080	Black	16.70
88123680	Silver	16.70

***1 End feed, protective conductor on the right for 3-phase busbars**

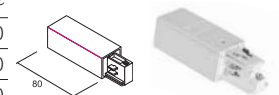

Item no.	Color	Price in €
88122070	White	16.70
88122080	Black	16.70
88122680	Silver	16.70

DALI

***2 End feed, protective conductor left for 1-phase tracks**



Item no.	Color	Price in €
88167070	White	19.30
88167080	Black	19.30
88167680	Silver	19.30

DALI

***2 End feed, protective conductor on the right for 1-phase busbars**

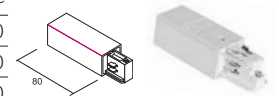

Item no.	Color	Price in €
88166070	White	19.30
88166080	Black	19.30
88166680	Silver	19.30

Electrical connector



Item no.	Color	Price in €
88114070	White	11.50
88114080	Black	11.50
88114680	Silver	11.50

Mechanical connector

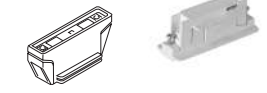

Item no.	Color	Price in €
88125070	White	7.50
88125080	Black	7.50

Corner connector 90°, inner protective conductor

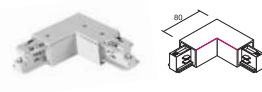

Item no.	Color	Price in €
88126070	White	37.10
88126080	Black	37.10
88126680	Silver	37.10

Corner connector 90°, outer protective conductor

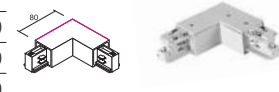

Item no.	Color	Price in €
88127070	White	37.10
88127080	Black	37.10
88127680	Silver	37.10

T-connector, protective conductor on the left

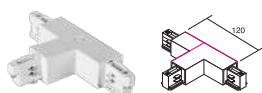

Item no.	Color	Price in €
88129070	White	57.00
88129080	Black	57.00
88129680	Silver	57.00

T-connector, protective conductor on the right

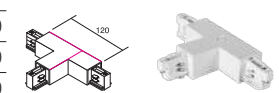

Item no.	Color	Price in €
88128070	White	57.00
88128080	Black	57.00
88128680	Silver	57.00

Flex corner connector, inner protective conductor

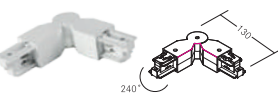

Item no.	Color	Price in €
88134070	White	57.10
88134080	Black	57.10
88134680	Silver	57.10

Cross connector

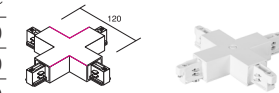

Item no.	Color	Price in €
88130070	White	73.10
88130080	Black	73.10
88130680	Silver	73.10

Center feed



Item no.	Color	Price in €
88124070	White	33.60
88124080	Black	33.60
88124680	Silver	33.60

Flexible connector



Item no.	Color	Price in €
88131070	White	45.20
88131080	Black	45.20
88131680	Silver	45.20

Stabilization plate, aluminum-raw



Item no.	Length	Price in €
88116250	120 mm	9.30

Ceiling mounting, aluminum-raw

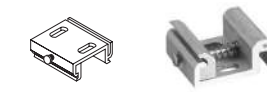

Item no.	Price in €
88119250	7.80

End piece



Item no.	Color	Price in €
88132070	White	2.30
88132080	Black	2.30
88132680	Silver	2.30

Penetration protection for busbar, 1,000 mm



Item no.	Color	Price in €
88133070	White	10.40
88133080	Black	10.40

Rope suspension with quick release



Item no.	Color	Suspension length	Price in €
88135000	Silver	2,000 mm	21.80
88136000	Silver	3,000 mm	30.10
88137000	Silver	5,000 mm	38.30

Rope thickness: 1.2 mm

Rope suspension with canopy



Item no.	Color	Price in €
88115070	White	7.50
88115080	Black	7.50

Rope thickness: 1.5 mm, suspension length of 2,000 mm

1

Interior lighting



06

BIRO40 light channel system.

The most filigree light channel from Brumberg – in standard lengths and individually configured.

BIRO40 recessed (standard)

Page 264

BIRO40 pendant (standard)

Page 266

BIRO40 surface-mounted (standard)

Page 265

BIRO40 configurator

Page 268



AWO | www.rengelbach.ch

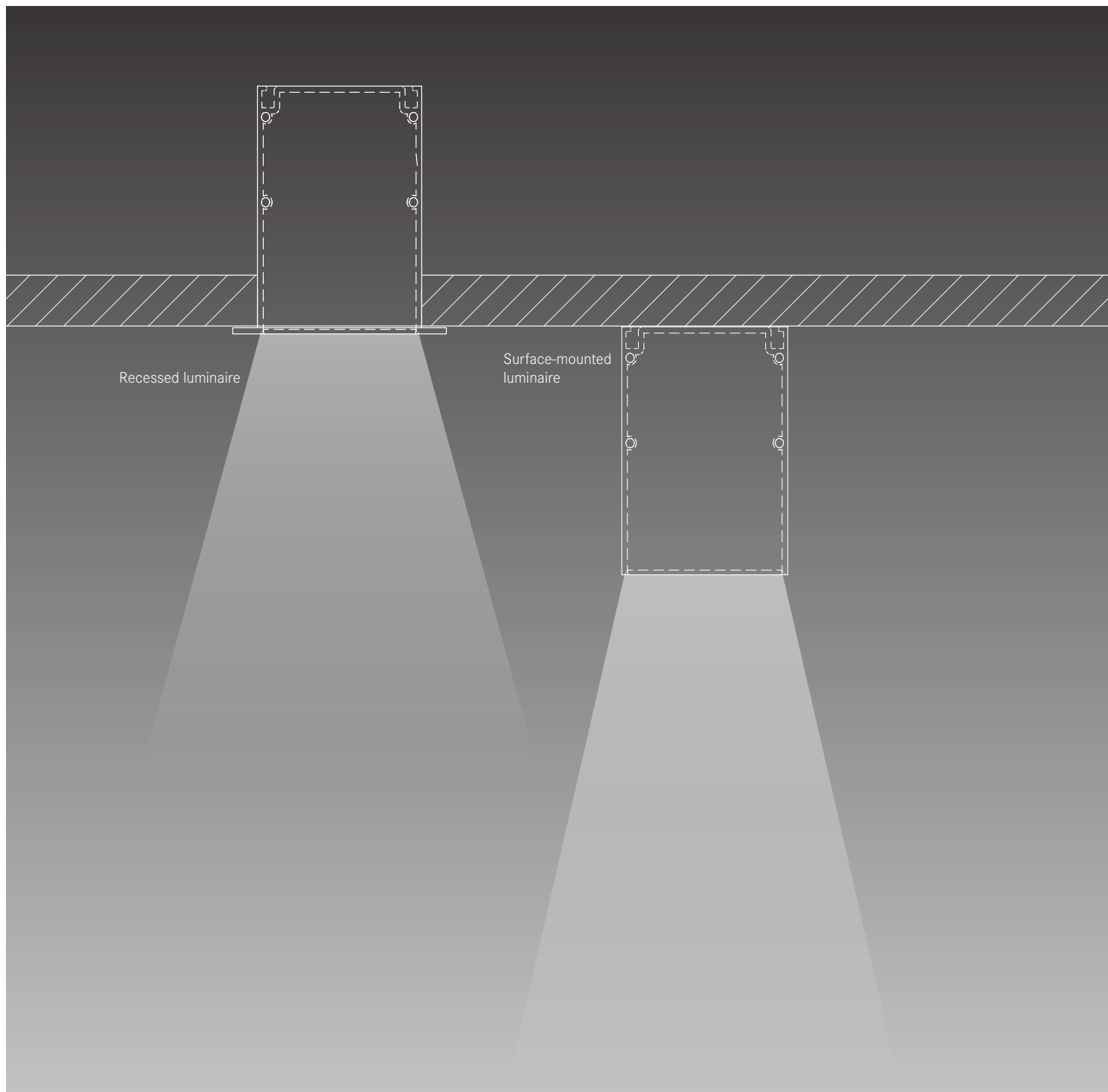

BIRO40 Light channel system.

Linear lighting solutions for modern room concepts.

The BIRO40 light channel system consists of a torsion-resistant aluminum profile and is available in three versions: as recessed, surface-mounted or pendant luminaire (direct or direct / indirect). In addition, the LED modules differ in their output and color temperature. This lighting system therefore offers the optimal lighting solution for every room typology. Various lighting tasks can be realized with the corresponding acrylic diffusers. With the BIRO40 light channel system, we implement flexible lighting concepts even better: Depending on customers' requirements, we supply standard lengths or customize the luminaires in terms of length, shape and color scheme.

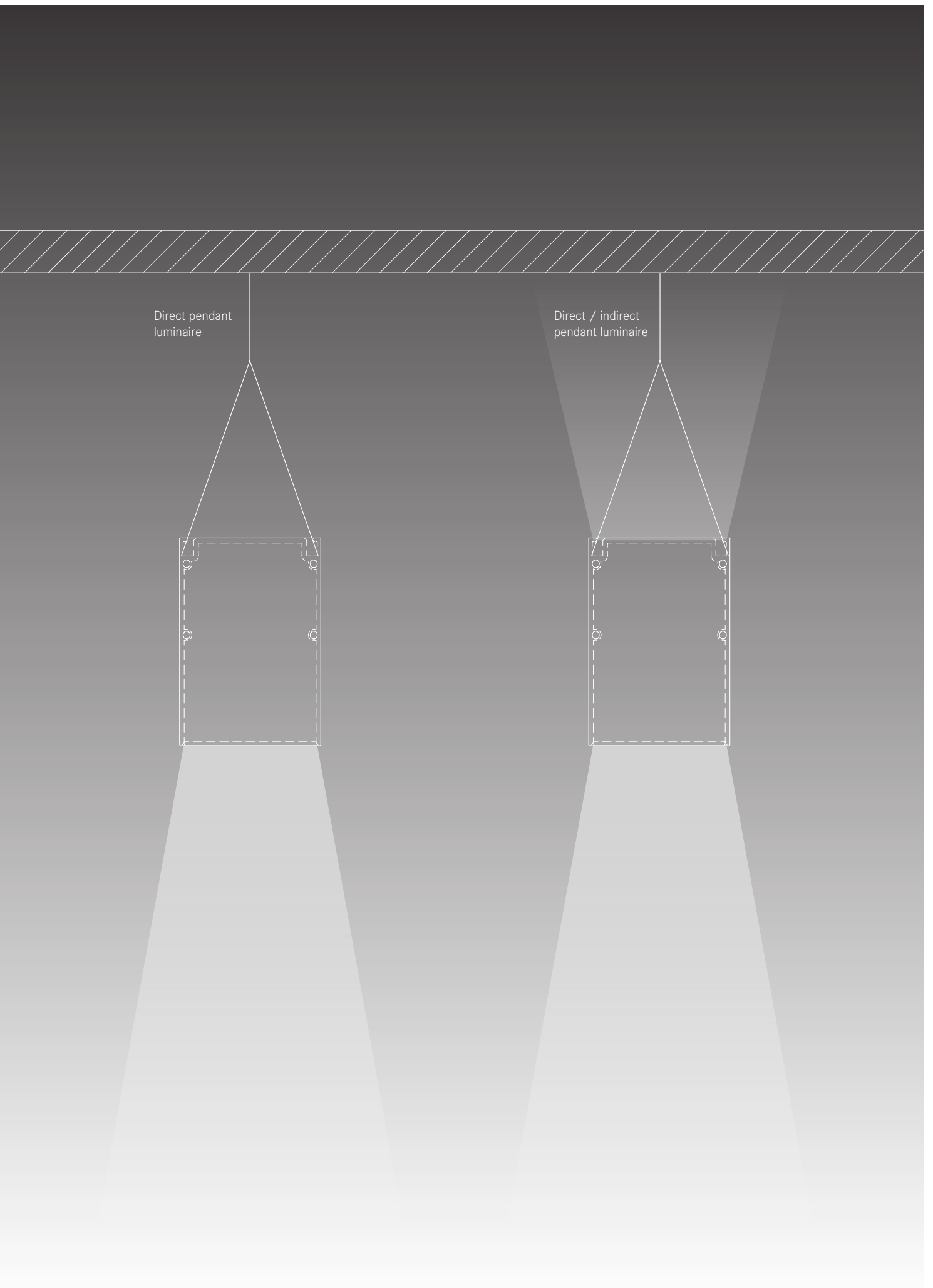

One profile, three applications.

1. Installation.

Suitable for recessed ceiling mounting. Recessed profile made of torsion-resistant rigid aluminum with extremely narrow luminaire body of 58 x 65 mm.

2. Surface mounting.

Suitable for ceiling mounting and wall mounting. Profiles made of torsion-resistant aluminum with extremely narrow luminaire body of 40 x 75 mm.

3. Suspension. Direct or direct/indirect.

Suitable for suspension mounting. Profiles made of torsion-resistant aluminum with extremely narrow luminaire body of 40 x 75 mm.

Design light.
Implement the geometries.

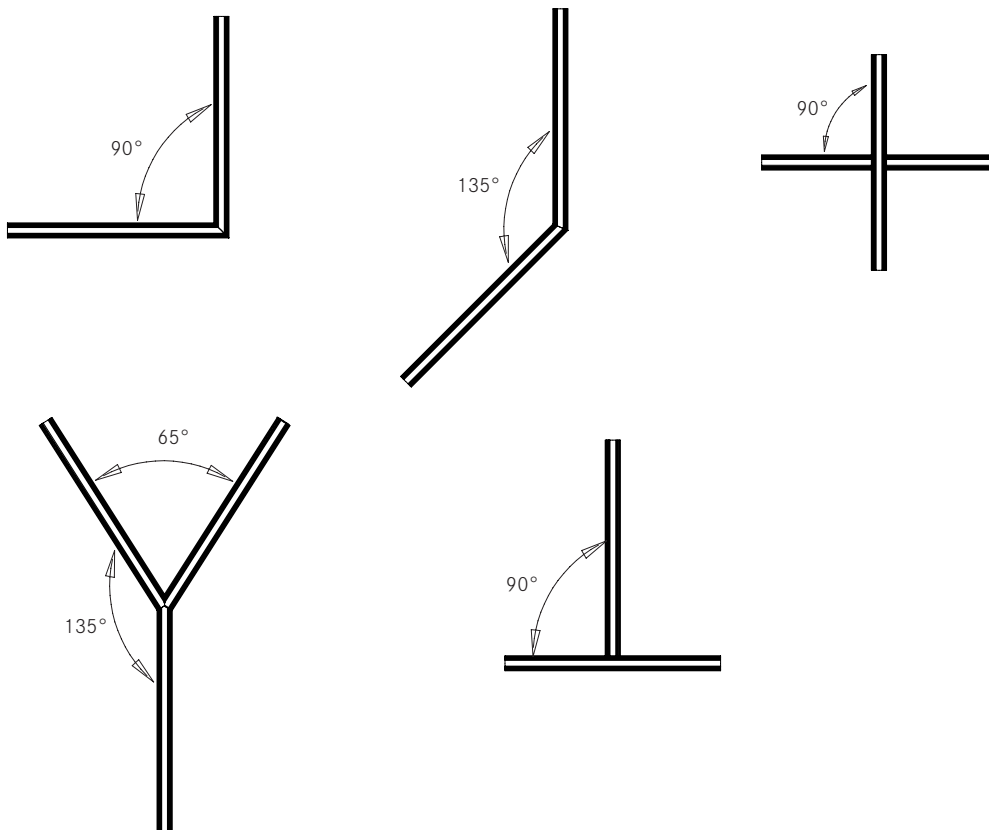

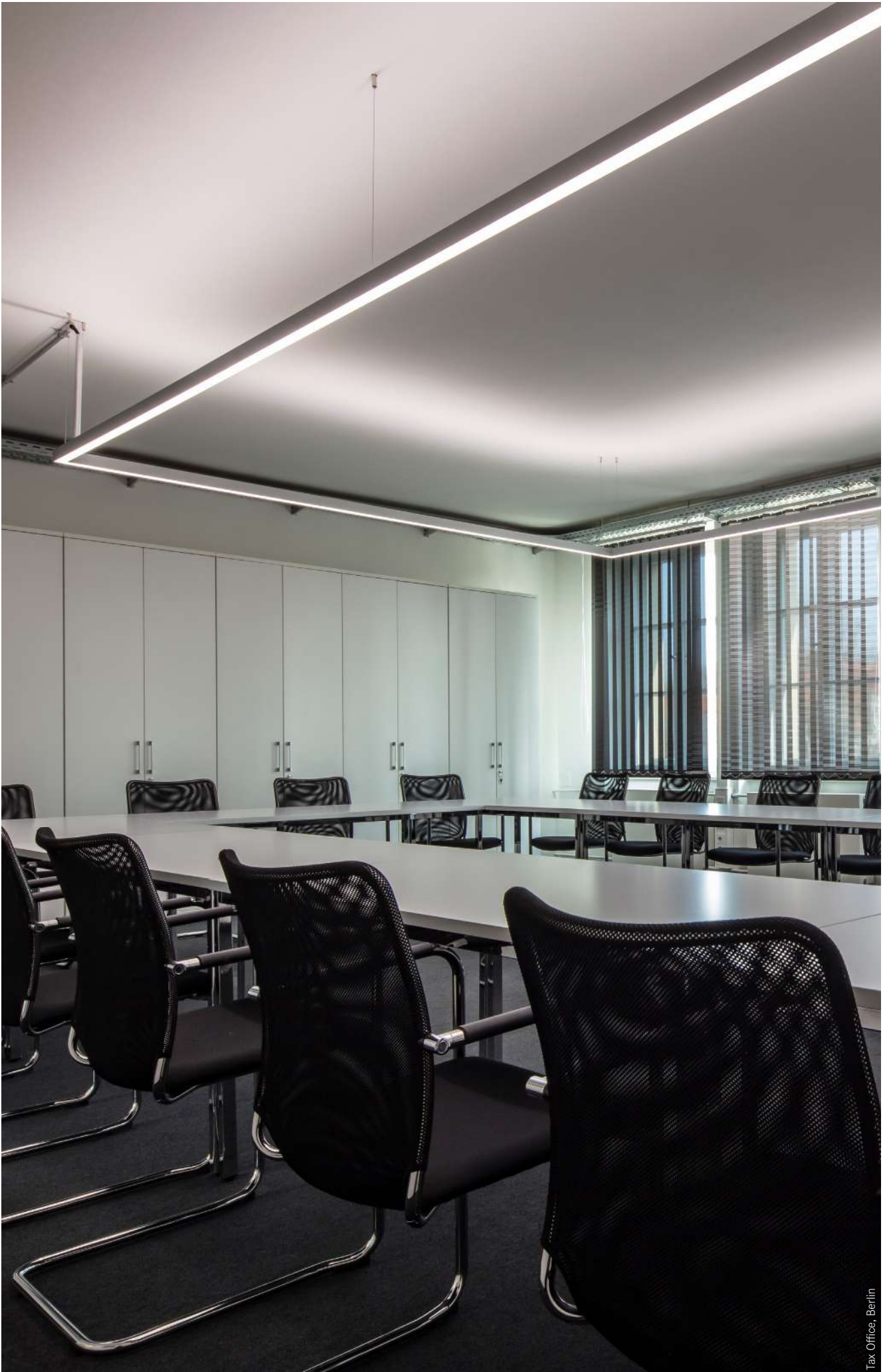

Tax Office, Berlin

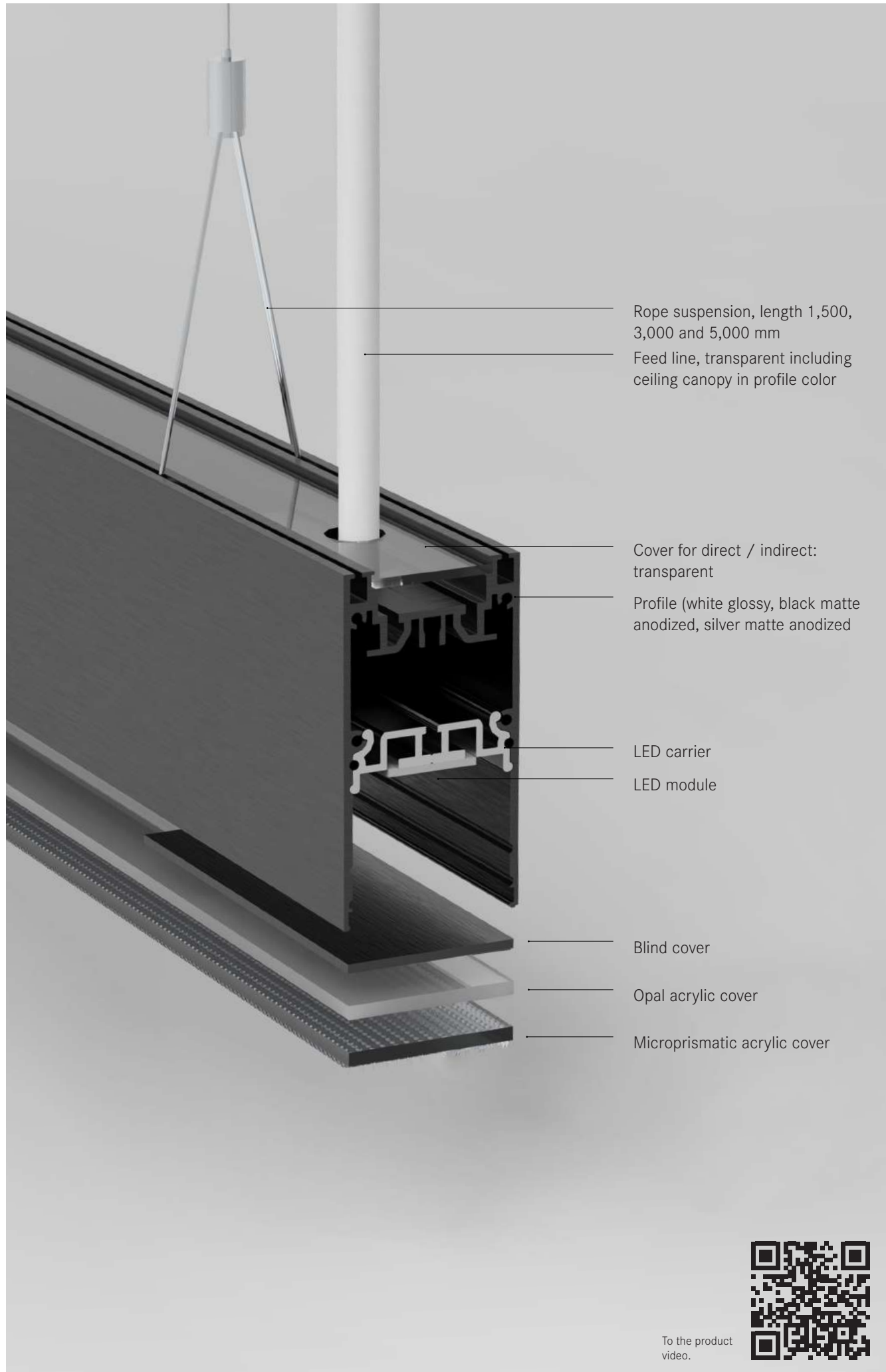

Rope suspension, length 1,500, 3,000 and 5,000 mm

Feed line, transparent including ceiling canopy in profile color

Cover for direct / indirect: transparent

Profile (white glossy, black matte anodized, silver matte anodized)

LED carrier

LED module

Blind cover

Opal acrylic cover

Microprismatic acrylic cover



To the product video.

Technology.

Monochrome

- Module - luminous efficacy: up to 124 lm / W
- Color rendering index CRI \geq 90
- Initial color consistency: \leq 3 SDCM
- Average service life: > 50,000 h (at $t_a = 25\text{ }^\circ\text{C}$)

TunableWhite

- Module - luminous efficacy: up to 102 lm / W with 2700 K
- Module - luminous efficacy: up to 122 lm / W with 6500 K
- Color rendering index CRI \geq 80
- Initial color consistency: < 3 SDCM
- Average service life: 50,000 h (at $t_a = 25\text{ }^\circ\text{C}$)

Covers.

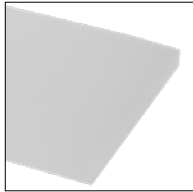

Opal acrylic cover flush-mounted with the surface.

For homogeneous basic illumination.



Blind cover.

For selective covering of the light exit.



Microprism acrylic cover flush-mounted with the surface.

For directional light with reduced stray light and glare.

For the opal and microprismatic covers, the expansion is up to 1.5 millimeters per running meter and $10\text{ }^\circ\text{C}$ temperature difference. The covers of the BIRO40 light channel system are light- and view-tight when installed with an upper gap of 2 millimeters or a lower overlap of 5 millimeters.

For optimum light distribution, the prismatic structure of the microprismatic cover must be mounted on the outside.

Overlap 5 mm

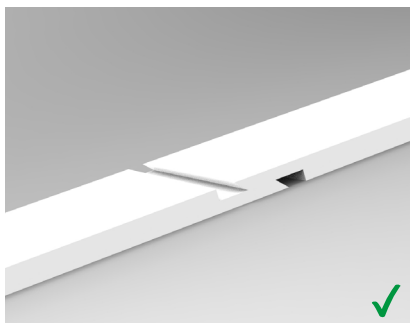

Minimum overlap

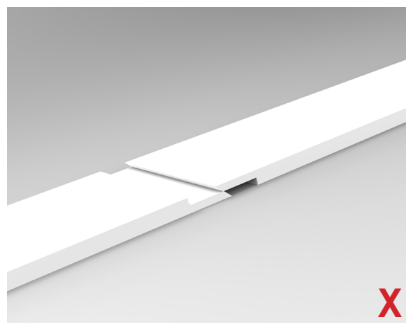

Maximum overlap

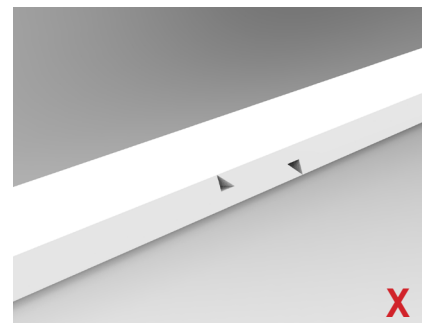

Removal tool.

For simplified assembly and disassembly, a removal tool for the LED carrier is included with every BIRO40 light channel system.



BIRO40.

Standard lengths. Recessed profile.

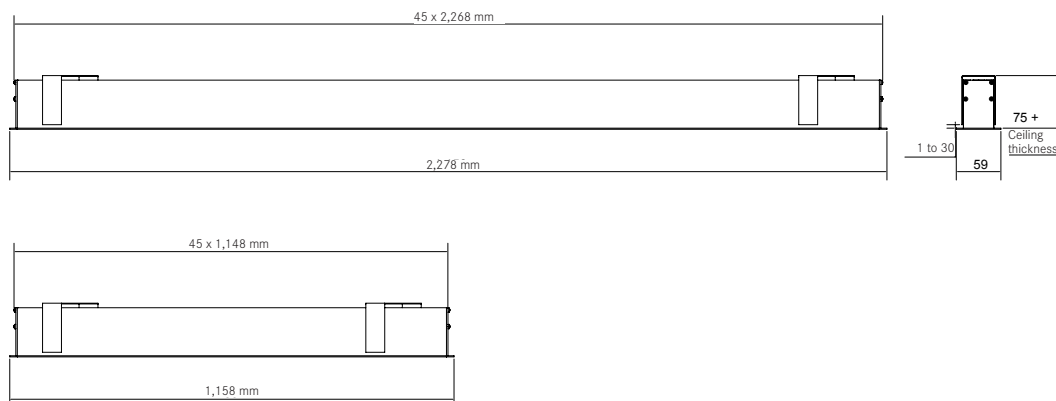

1,158 mm and 2,278 mm to 5,470 lm
color rendering: CRI > 90, TunableWhite CRI > 80

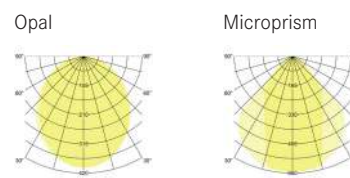

Length	Item no. white glossy	Item no. black matte anodized	Item no. silver matte anodized	Color temperature	Cover	UGR	Controlling	Luminous flux	System efficiency	System Power	Price in €
1,158 mm	77013073	77013083	77013693	3000 K	Opal	< 25	Switchable	2,430 lm	78 lm/W	31 W	309.00
1,158 mm	77033073	77033083	77033693	3000 K	Opal	< 25	DALI	2,430 lm	78 lm/W	31 W	349.00
1,158 mm	77013074	77013084	77013694	4000 K	Opal	< 25	Switchable	2,740 lm	87 lm/W	31 W	309.00
1,158 mm	77033074	77033084	77033694	4000 K	Opal	< 25	DALI	2,740 lm	87 lm/W	31 W	369.00
1,158 mm	77033078	77033088	77033698	2700 K- 6500 K	Opal	< 25	DALI	2,690 lm	86 lm/W	31 W	539.00
2,278 mm	77014073	77014083	77014693	3000 K	Opal	< 25	Switchable	4,840 lm	77 lm/W	62 W	509.00
2,278 mm	77034073	77034083	77034693	3000 K	Opal	< 25	DALI	4,840 lm	77 lm/W	62 W	599.00
2,278 mm	77014074	77014084	77014694	4000 K	Opal	< 25	Switchable	5,470 lm	87 lm/W	62 W	509.00
2,278 mm	77034074	77034084	77034694	4000 K	Opal	< 25	DALI	5,470 lm	87 lm/W	62 W	599.00
2,278 mm	77034078	77034088	77034698	2700 K- 6500 K	Opal	< 25	DALI	5,380 lm	86 lm/W	62 W	789.00
1,158 mm	77003073	77003083	77003693	3000 K	Microprism	< 19	Switchable	1,430 lm	80 lm/W	18 W	329.00
1,158 mm	77023073	77023083	77023693	3000 K	Microprism	< 19	DALI	1,430 lm	80 lm/W	18 W	369.00
1,158 mm	77003074	77003084	77003694	4000 K	Microprism	< 19	Switchable	1,620 lm	90 lm/W	18 W	329.00
1,158 mm	77023074	77023084	77023694	4000 K	Microprism	< 19	DALI	1,620 lm	90 lm/W	18 W	369.00
1,158 mm	77023078	77023088	77023698	2700 K- 6500 K	Microprism	< 19	DALI	1,590 lm	89 lm/W	18 W	559.00
2,278 mm	77004073	77004083	77004693	3000 K	Microprism	< 19	Switchable	2,860 lm	80 lm/W	36 W	539.00
2,278 mm	77024073	77024083	77024693	3000 K	Microprism	< 19	DALI	2,860 lm	80 lm/W	36 W	619.00
2,278 mm	77004074	77004084	77004694	4000 K	Microprism	< 19	Switchable	3,230 lm	90 lm/W	36 W	539.00
2,278 mm	77024074	77024084	77024694	4000 K	Microprism	< 19	DALI	3,230 lm	90 lm/W	36 W	619.00
2,278 mm	77024078	77024088	77024698	2700 K- 6500 K	Microprism	< 19	DALI	3,180 lm	89 lm/W	36 W	819.00

These items are subject to discount group 2.

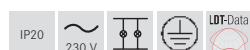

BIRO40.

Standard lengths. Mounting profile.

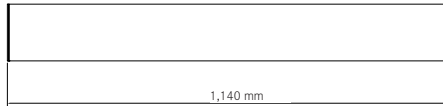
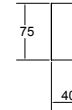
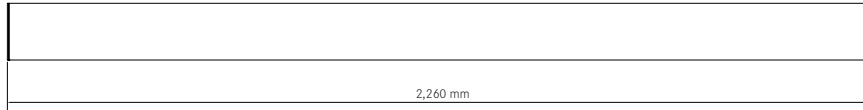

reddot winner 2021
lighting design

1,140 mm and 2,260 mm to 5,470 lm
color rendering: CRI > 90, TunableWhite CRI > 80

Opal

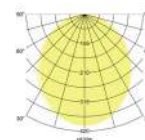

Microprism

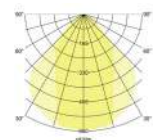

Length	Item no. black matte anodized	Item no. silver matte anodized	Color temperature	Cover	UGR	Controlling	Luminous flux	System efficiency	System power	Price in €
1,140 mm	77123083	77123693	3000 K	Opal	< 25	Switchable	2,430 lm	78 lm/W	31 W	279.00
1,140 mm	77143083	77143693	3000 K	Opal	< 25	DALI	2,430 lm	78 lm/W	31 W	319.00
1,140 mm	77123084	77123694	4000 K	Opal	< 25	Switchable	2,740 lm	87 lm/W	31 W	279.00
1,140 mm	77143084	77143694	4000 K	Opal	< 25	DALI	2,740 lm	87 lm/W	31 W	319.00
1,140 mm	77143088	77143698	2700 K- 6500 K	Opal	< 25	DALI	2,690 lm	86 lm/W	31 W	519.00
2,260 mm	77124083	77124693	3000 K	Opal	< 25	Switchable	4,840 lm	77 lm/W	62 W	479.00
2,260 mm	77144083	77144693	3000 K	Opal	< 25	DALI	4,840 lm	77 lm/W	62 W	559.00
2,260 mm	77124084	77124694	4000 K	Opal	< 25	Switchable	5,470 lm	87 lm/W	62 W	479.00
2,260 mm	77144084	77144694	4000 K	Opal	< 25	DALI	5,470 lm	87 lm/W	62 W	559.00
2,260 mm	77144088	77144698	2700 K- 6500 K	Opal	< 25	DALI	5,380 lm	86 lm/W	62 W	759.00
1,140 mm	77113083	77113693	3000 K	Microprism	< 19	Switchable	1,430 lm	80 lm/W	18 W	289.00
1,140 mm	77133083	77133693	3000 K	Microprism	< 19	DALI	1,430 lm	80 lm/W	18 W	329.00
1,140 mm	77113084	77113694	4000 K	Microprism	< 19	Switchable	1,620 lm	90 lm/W	18 W	289.00
1,140 mm	77133084	77133694	4000 K	Microprism	< 19	DALI	1,620 lm	90 lm/W	18 W	329.00
1,140 mm	77133088	77133698	2700 K- 6500 K	Microprism	< 19	DALI	1,590 lm	89 lm/W	18 W	529.00
2,260 mm	77114083	77114693	3000 K	Microprism	< 19	Switchable	2,860 lm	80 lm/W	36 W	499.00
2,260 mm	77134083	77134693	3000 K	Microprism	< 19	DALI	2,860 lm	80 lm/W	36 W	589.00
2,260 mm	77114084	77114694	4000 K	Microprism	< 19	Switchable	3,230 lm	90 lm/W	36 W	499.00
2,260 mm	77134084	77134694	4000 K	Microprism	< 19	DALI	3,230 lm	90 lm/W	36 W	589.00
2,260 mm	77134088	77134698	2700 K- 6500 K	Microprism	< 19	DALI	3,180 lm	89 lm/W	36 W	779.00

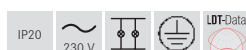

These items are subject to discount group 2.

BIRO40.

Standard lengths. Direct suspension profile.

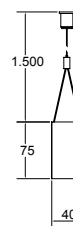
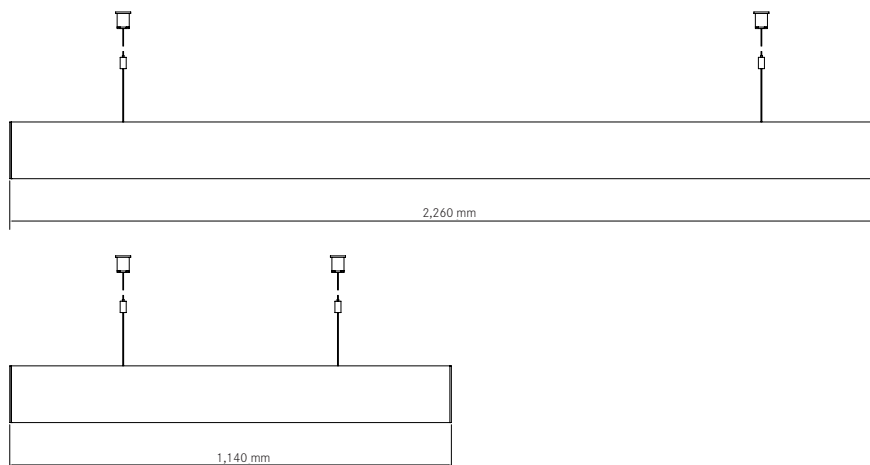

1,140 mm and 2,260 mm to 5,470 mm
color rendering: CRI > 90, TunableWhite CRI > 80

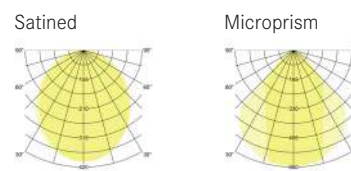

Length	Item no. black matte anodized	Item no. silver matte anodized	Color temperature	Cover	UGR	Controlling	Luminous flux	System efficiency	System power	Price in €
1,140 mm	77223083	77223693	3000 K	Satiné	< 25	Switchable	2,430 lm	78 lm/W	31 W	379.00
1,140 mm	77243083	77243693	3000 K	Satiné	< 25	DALI	2,430 lm	78 lm/W	31 W	419.00
1,140 mm	77223084	77223694	4000 K	Satiné	< 25	Switchable	2,740 lm	87 lm/W	31 W	379.00
1,140 mm	77243084	77243694	4000 K	Satiné	< 25	DALI	2,740 lm	87 lm/W	31 W	419.00
1,140 mm	77243088	77243698	2700 K- 6500 K	Satiné	< 25	DALI	2,690 lm	86 lm/W	31 W	589.00
2,260 mm	77224083	77224693	3000 K	Satiné	< 25	Switchable	4,840 lm	77 lm/W	62 W	579.00
2,260 mm	77244083	77244693	3000 K	Satiné	< 25	DALI	4,840 lm	77 lm/W	62 W	669.00
2,260 mm	77224084	77224694	4000 K	Satiné	< 25	Switchable	5,470 lm	87 lm/W	62 W	579.00
2,260 mm	77244084	77244694	4000 K	Satiné	< 25	DALI	5,470 lm	87 lm/W	62 W	669.00
2,260 mm	77244088	77244698	2700 K- 6500 K	Satiné	< 25	DALI	5,380 lm	86 lm/W	62 W	859.00
1,140 mm	77213083	77213693	3000 K	Microprism	< 19	Switchable	1,430 lm	80 lm/W	18 W	389.00
1,140 mm	77233083	77233693	3000 K	Microprism	< 19	DALI	1,430 lm	80 lm/W	18 W	439.00
1,140 mm	77213084	77213694	4000 K	Microprism	< 19	Switchable	1,620 lm	90 lm/W	18 W	389.00
1,140 mm	77233084	77233694	4000 K	Microprism	< 19	DALI	1,620 lm	90 lm/W	18 W	439.00
1,140 mm	77233088	77233698	2700 K- 6500 K	Microprism	< 19	DALI	1,590 lm	89 lm/W	18 W	599.00
2,260 mm	77214083	77214693	3000 K	Microprism	< 19	Switchable	2,860 lm	80 lm/W	36 W	609.00
2,260 mm	77234083	77234693	3000 K	Microprism	< 19	DALI	2,860 lm	80 lm/W	36 W	689.00
2,260 mm	77214084	77214694	4000 K	Microprism	< 19	Switchable	3,230 lm	90 lm/W	36 W	609.00
2,260 mm	77234084	77234694	4000 K	Microprism	< 19	DALI	3,230 lm	90 lm/W	36 W	689.00
2,260 mm	77234088	77234698	2700 K- 6500 K	Microprism	< 19	DALI	3,180 lm	89 lm/W	36 W	889.00

These items are subject to discount group 2.

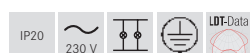

BIRO40.

Standard lengths. Suspension profile - direct/indirect

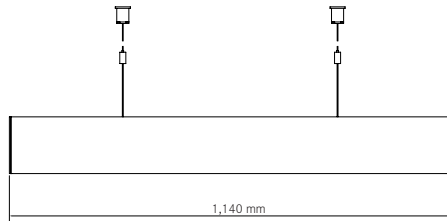
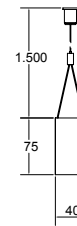
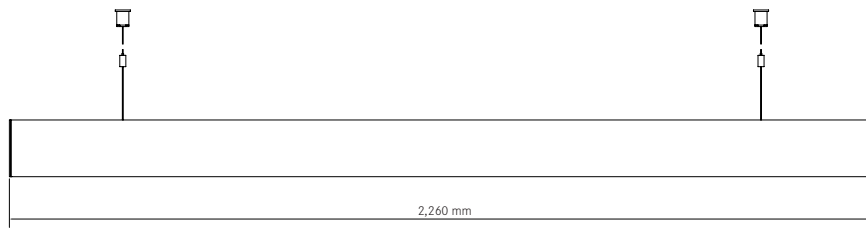

1,140 mm and 2,260 mm to 11,810 mm
color rendering: CRI > 90, TunableWhite CRI > 80

Satined

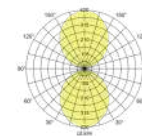

Microprism

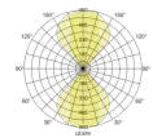

Length	Item no. black matte anodized	Item no. silver matte anodized	Color temperature	Cover	UGR	Controlling	Luminous flux	System efficiency	System power	Price in €
1,140 mm	77323083	77323693	3000 K	Satined	< 20	Switchable	4,970 lm	108 lm/W	46 W	469.00
1,140 mm	77353083	77353693	3000 K	Satined	< 20	DALI	4,970 lm	108 lm/W	46 W	519.00
1,140 mm	77323084	77323694	4000 K	Satined	< 20	Switchable	5,600 lm	122 lm/W	46 W	469.00
1,140 mm	77353084	77353694	4000 K	Satined	< 20	DALI	5,600 lm	122 lm/W	46 W	519.00
1,140 mm	77353088	77353698	2700 K- 6500 K	Satined	< 20	DALI	5,520 lm	120 lm/W	46 W	679.00
2,260 mm	77324083	77324693	3000 K	Satined	< 20	Switchable	10,260 lm	108 lm/W	95 W	759.00
2,260 mm	77354083	77354693	3000 K	Satined	< 20	DALI	10,260 lm	108 lm/W	95 W	849.00
2,260 mm	77324084	77324694	4000 K	Satined	< 20	Switchable	11,580 lm	122 lm/W	95 W	759.00
2,260 mm	77354084	77354694	4000 K	Satined	< 20	DALI	11,580 lm	122 lm/W	95 W	849.00
2,260 mm	77354088	77354698	2700 K- 6500 K	Satined	< 20	DALI	11,400 lm	120 lm/W	95 W	1,149.00
1,140 mm	77313083	77313693	3000 K	Microprism	< 19	Switchable	5,060 lm	110 lm/W	46 W	479.00
1,140 mm	77333083	77333693	3000 K	Microprism	< 19	DALI	5,060 lm	110 lm/W	46 W	529.00
1,140 mm	77313084	77313694	4000 K	Microprism	< 19	Switchable	5,720 lm	124 lm/W	46 W	479.00
1,140 mm	77333084	77333694	4000 K	Microprism	< 19	DALI	5,720 lm	124 lm/W	46 W	529.00
1,140 mm	77333088	77333698	2700 K- 6500 K	Microprism	< 19	DALI	5,630 lm	122 lm/W	46 W	689.00
2,260 mm	77314083	77314693	3000 K	Microprism	< 19	Switchable	10,460 lm	110 lm/W	95 W	779.00
2,260 mm	77334083	77334693	3000 K	Microprism	< 19	DALI	10,460 lm	110 lm/W	95 W	879.00
2,260 mm	77314084	77314694	4000 K	Microprism	< 19	Switchable	11,810 lm	124 lm/W	95 W	779.00
2,260 mm	77334084	77334694	4000 K	Microprism	< 19	DALI	11,810 lm	124 lm/W	95 W	879.00
2,260 mm	77334088	77334698	2700 K- 6500 K	Microprism	< 19	DALI	11,620 lm	122 lm/W	95 W	1,179.00

These items are subject to discount group 2.

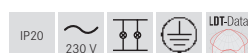

BIRO40 Light channel system configurator.

Individuality. Easy to plan.

Using the new BIRO40 light channel system configurator, you can put together your Brumberg light channel both quickly and with ease. First select the desired mounting type, color, color temperature, control and the corresponding cover. Special shapes can also be configured. Finally, you will get a detailed planning overview.

You can start your configuration now at: www.brumberg.com

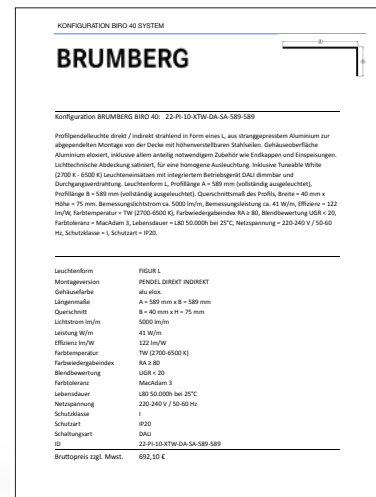
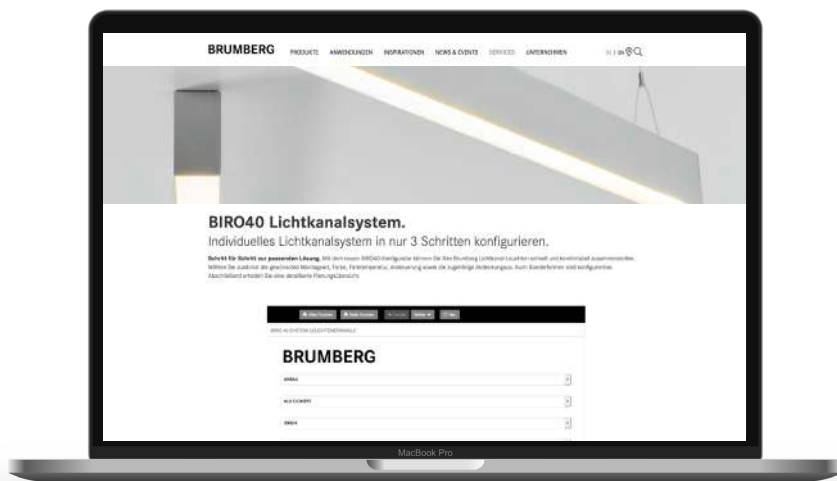

BIRO40 Light channel system configurator.

Customize your BIRO40 light channel system in just a few steps.

1. Select luminaire features.
2. Specify the length.
3. Check the configuration.

4. Print configuration or save as PDF.



Configure online now.

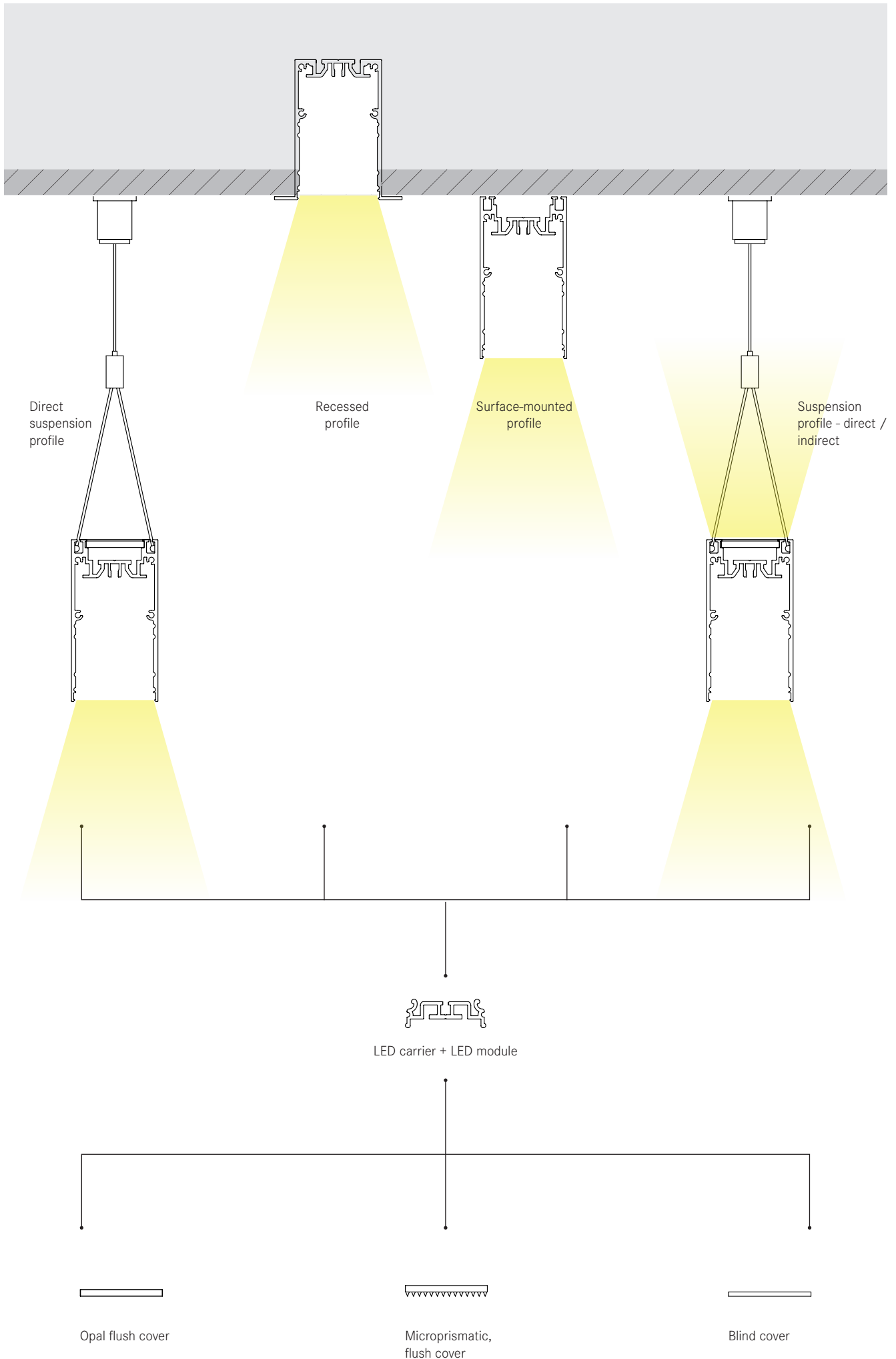

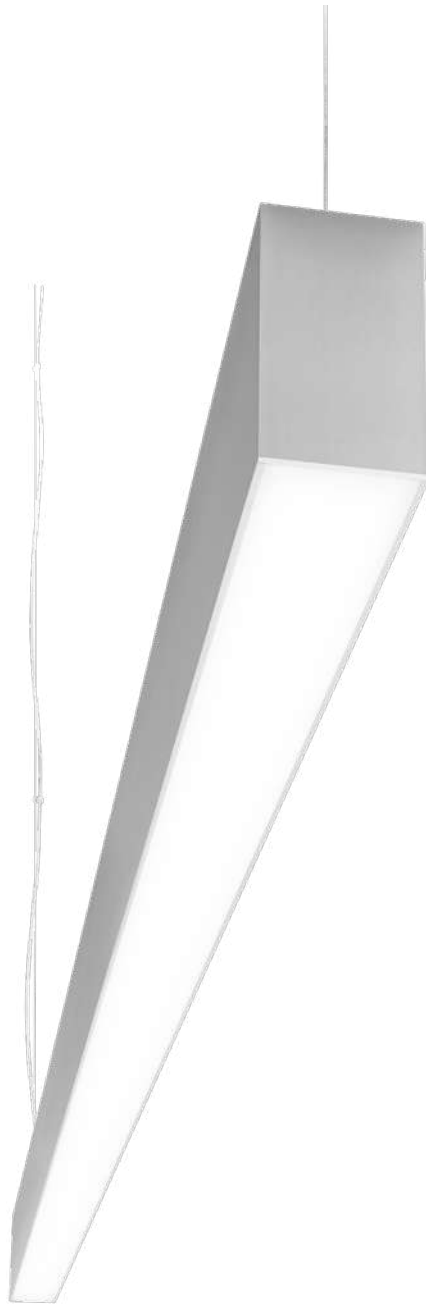

The focus is on people. Lighting technology. For creative ideas.

Companies are increasingly adapting room design and office lighting to the needs of their employees. Since the focus is on people and their ideas, the light must be aligned with the various visual tasks: Flexible illumination and glare-free light at the workplace keep the eyes from getting tired quickly, facilitate presentations or meetings, and create a pleasant atmosphere. With various surfaces, covers and color temperatures, the BIRO40 light channel system creates ideal lighting conditions for productive work.

With its clean lines and timeless minimalist design, the light channel fits perfectly into modern room concepts. Thanks to the numerous connection options, various geometries can be realized to emphasize lines and room design. The light channel is obviously 100 percent illuminated even with special shapes. This makes the BIRO40 light channel system ideal for design-oriented living concepts.

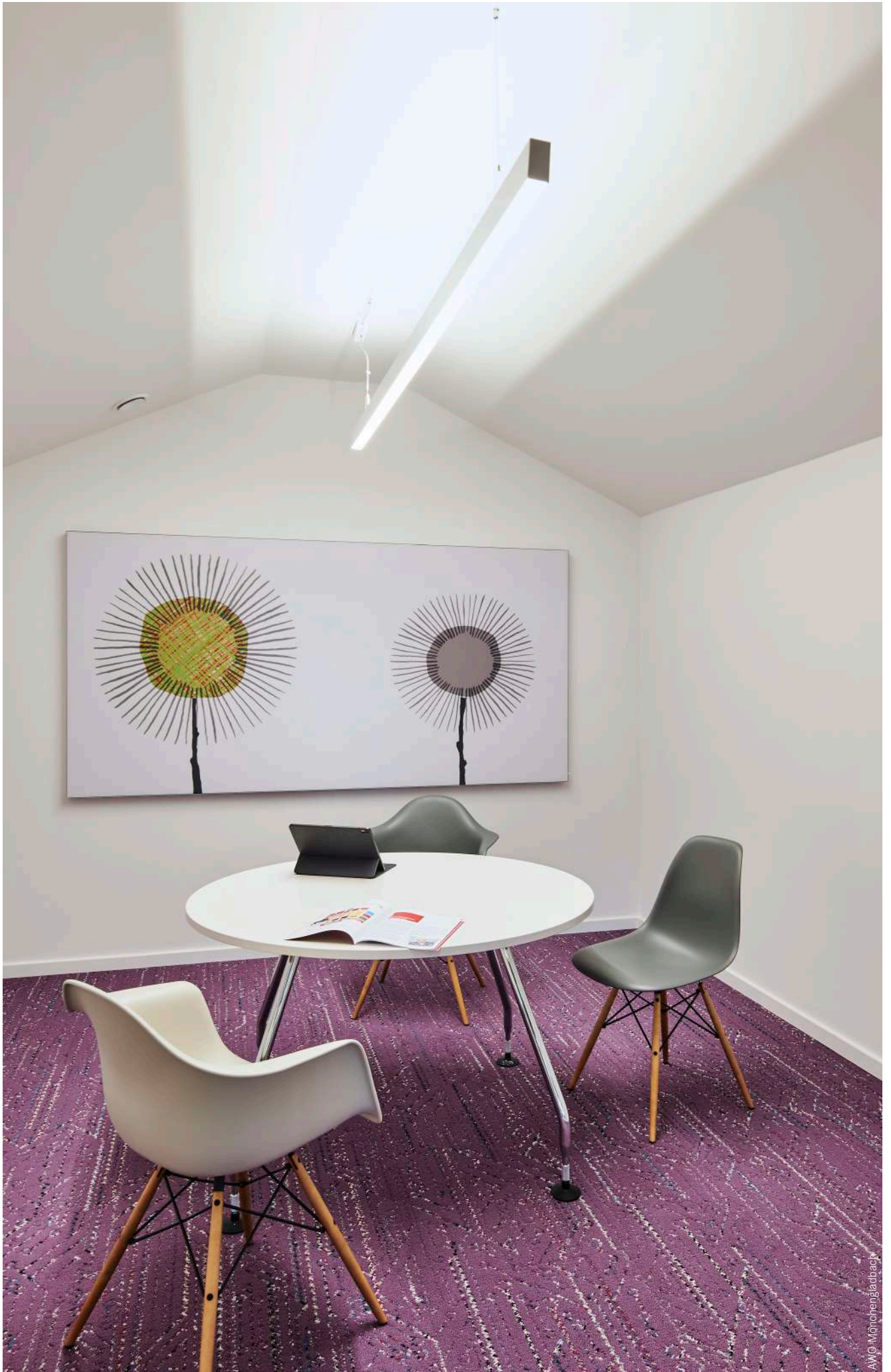

1

Interior lighting



07

QualityFlex.

LED flex boards for basic and accent lighting.

BB-Flex

Page 274

Special Applications

Page 316

Complete flex sets

Page 286

Offshore

Page 346

Select

Page 290

Profiles

Page 364

Performance

Page 302



The Bernstein, Bielefeld

QualityFlex BB-Flex

5 m, 4.8 W / m

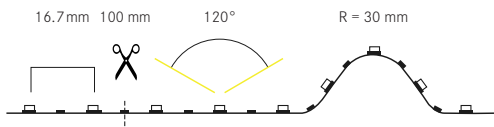

	24 VDC		4.8 W/m		CRI > 80		5,000 mm		60/m		16.7mm		dimmable
	-10 to +40 °C		IP00										

NEW

Electrical data

LED circuit board:	SMD-LED 2835
Power consumption:	4.8 W/m
Number of LEDs per meter:	60
Rated voltage:	24 VDC
Protection class:	III
Ambient temperature:	-10 to +40 °C

Photometric data

Color rendering index:	CRI > 80
Color consistency:	SDCM < 5
Efficiency:	109 lm/W at IP00, 3000 K

Light technical data

Beam angle:	120°
-------------	------

Service life:

Service life:	L80/B10: 50,000 h L70/B50: > 50,000 h
---------------	--

Mechanical data

Length of the board:	5,000 mm
Maximum module length:	5,000 mm
Pitch dimension:	100 mm
Smallest bending radius:	30 mm
Short pitch:	16.7 mm
Connection cable:	2 x 300 mm
Self-adhesive:	yes

For heat dissipation, it is absolutely necessary to mount on aluminum profiles.

For an optimum price/performance ratio, we recommend using the BB profiles from page 282 onwards.

Please refer to the profile overview on the right side for more profiles.

Key features of the products

- Suitable for indoor applications (IP00).
- Decorative illumination of furniture, objects and light covers.
- Length 5,000 mm with a pitch of 100 mm.
- Service life L80/B10: 50,000 hours.
- Optimum heat dissipation using suitable aluminum profiles.
- Dimmable using suitable accessories.

Variants of LED flex boards



Item no.	Price in €	Color temperature	Luminous flux/m	EEL Spectrum A-G	Dimensions [W x H]
38201027	79.00	2700 K	Approximately 490 lm	E	8 x 1.2 mm
38201003	79.00	3000 K	Approximately 525 lm	E	8 x 1.2 mm
38201004	79.00	4000 K	Approximately 490 lm	E	8 x 1.2 mm

IP00

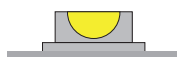

Uncoated LED flex board for indoor application in dry areas. Do not wipe with a damp cloth.



Profile overview

Surface-mounted profiles



Recessed profiles

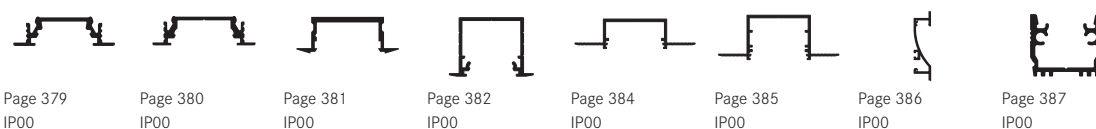

Surface-mounted corner profiles



Special profiles

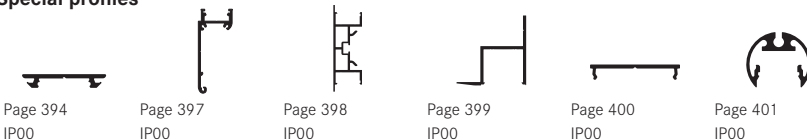

Based on the flex board with protection class IP00 in combination with an opal cover:

■ Homogeneous lighting pattern is possible, ■ LED points are visible, no homogeneous lighting pattern, ■ cannot be combined with the flex board
 * = a homogeneous light line is only possible in combination with a high cover

Power supplies



Switchable

Item no. 17241000
LED power supply 24 V DC, 40 W, switchable
 For operation up to 5,000 mm (page 534)



Dimmable

Item no. 17528000
White light radio controller
 for controlling single-color LED modules in the white light range
 Page 543



Dimmable

Item no. 17230000
LED power supply 24 V DC, 30 W, dimmable phase section
 For operation up to 5,000 mm (page 535)

You will find additional power supplies and controllers from page 530 onwards.

QualityFlex BB-Flex

5 m, 9.6 W / m

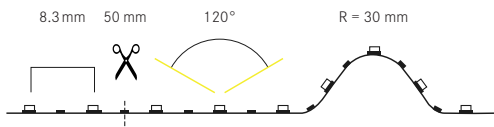

	24 VDC	9.6 W/m	CRI > 80	5,000 mm	120/m	8.3mm	dimmi-ble
	-10 to +40 °C						

NEW

Electrical data

LED circuit board:	SMD-LED 2835
Power consumption:	9.6 W/m
Number of LEDs per meter:	120
Rated voltage:	24 VDC
Protection class:	III
Ambient temperature:	-10 to +40 °C

Photometric data

Color rendering index:	CRI > 80
Color consistency:	SDCM < 5
Efficiency:	102 lm/W at IP00, 3000 K

Light technical data

Beam angle:	120°
-------------	------

Service life:

Service life:	L80/B10: 50,000 h L70/B50: > 50,000 h
---------------	--

Mechanical data

Length of the board:	5,000 mm
Maximum module length:	5,000 mm
Pitch dimension:	50 mm
Smallest bending radius:	30 mm
Short pitch:	8.3 mm
Connection cable:	2 x 300 mm
Self-adhesive:	yes

For heat dissipation, it is absolutely necessary to mount on aluminum profiles.

For an optimum price/performance ratio, we recommend using the BB profiles from page 282 onwards.

Please refer to the profile overview on the right side for more profiles.

Key features of the products

- Suitable for indoor applications (IP00).
- Decorative illumination of furniture, objects and light covers.
- Indirect illumination in residential areas.
- Length 5,000 mm with a pitch of 50 mm.
- Available in 2700 K, 3000 K and 4000 K.
- Dimmable using suitable accessories.



Variants of LED flex boards

Item no.	Price in €	Color temperature	Luminous flux/m	EEL Spectrum A-G	Dimensions [W x H]
38202027	119.00	2700 K	Approximately 894 lm	F	8 x 1.2 mm
38202003	119.00	3000 K	Approximately 986 lm	E	8 x 1.2 mm
38202004	119.00	4000 K	Approximately 894 lm	F	8 x 1.2 mm

IP00

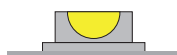

Uncoated LED flex board for indoor application in dry areas. Do not wipe with a damp cloth.



Profile overview

Surface-mounted profiles



Recessed profiles

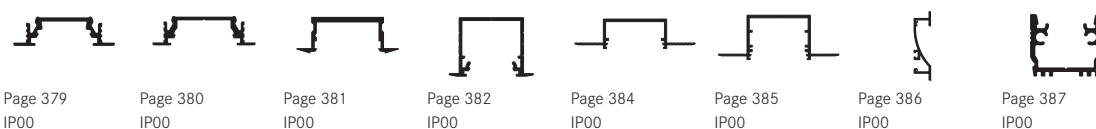

Surface-mounted corner profiles



Special profiles

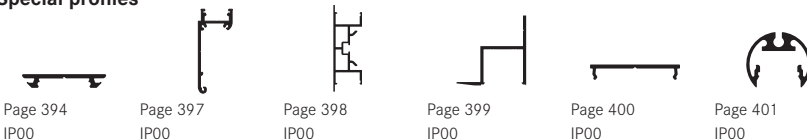

Based on the flex board with protection class IP00 in combination with an opal cover:

■ Homogeneous lighting pattern is possible, ■ LED points are visible, no homogeneous lighting pattern, ■ cannot be combined with the flex board
 * = a homogeneous light line is only possible in combination with a high cover

Power supplies



Switchable

Item no. 17242000
LED power supply 24 V DC, 60 W, switchable
 For operation up to 5,000 mm (page 534)



Dimmable

Item no. 17528000
White light radio controller
 for controlling single-color LED modules in the white light range
 Page 543



Dimmable

Item no. 17231000
LED power supply 24 V DC, 75 W, dimmable phase section
 For operation up to 5,000 mm (page 535)

You will find additional power supplies and controllers from page 530 onwards.

QualityFlex BB-Flex

5 m, 14.4 W / m

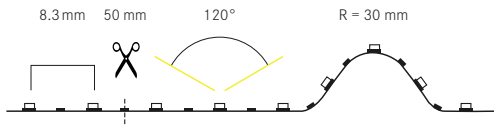

	24 VDC	14.4 W/m	CRI > 80	5,000 mm	120/m	8.3mm	dimmi able
	-10 to +40 °C						

NEW

Electrical data

LED circuit board:	SMD-LED 2835
Power consumption:	14.4 W/m
Number of LEDs per meter:	120
Rated voltage:	24 VDC
Protection class:	III
Ambient temperature:	-10 to +40 °C

Photometric data

Color rendering index:	CRI > 80
Color consistency:	SDCM < 5
Efficiency:	94 lm/W at IP00, 3000 K

Light technical data

Beam angle:	120°
-------------	------

Service life:

Service life:	L80/B10: 50,000 h L70/B50: > 50,000 h
---------------	--

Mechanical data

Length of the board:	5,000 mm
Maximum module length:	5,000 mm
Pitch dimension:	50 mm
Smallest bending radius:	30 mm
Short pitch:	8.3 mm
Connection cable:	2 x 300 mm
Self-adhesive:	yes

For heat dissipation, it is absolutely necessary to mount on aluminum profiles.

For an optimum price/performance ratio, we recommend using the BB profiles from page 282 onwards.

Please refer to the profile overview on the right side for more profiles.

Key features of the products

- Suitable for indoor applications (IP00).
- Direct illumination of working areas (e.g.: in a kitchen).
- Indirect illumination in residential areas.
- Length 5,000 mm with a pitch of 50 mm.
- Color consistency SDCM < 5.
- Available in 2700 K, 3000 K and 4000 K.
- Dimmable using suitable accessories.

Variants of LED flex boards



Item no. 5,000 mm	Price in €	Color temperature	Luminous flux/m	EEK Spectrum A-G	Dimensions [W x H]
38203027	179.00	2700 K	Approximately 1,271 lm	F	8 x 1.2 mm
38203003	179.00	3000 K	Approximately 1,354 lm	F	8 x 1.2 mm
38203004	179.00	4000 K	Approximately 1,271 lm	F	8 x 1.2 mm

IP00

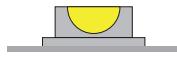

Uncoated LED flex board for indoor application in dry areas. Do not wipe with a damp cloth.



Profile overview

Surface-mounted profiles



Recessed profiles

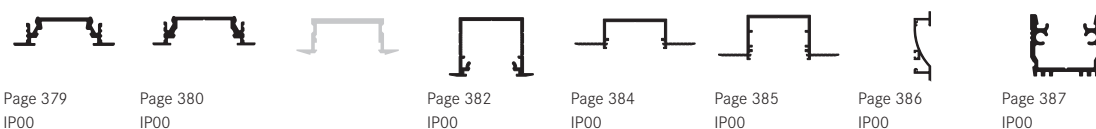

Surface-mounted corner profiles



Special profiles



Based on the flex board with protection class IP00 in combination with an opal cover:

- Homogeneous lighting pattern is possible, ■ LED points are visible, no homogeneous lighting pattern, ■ cannot be combined with the flex board
- * = a homogeneous light line is only possible in combination with a high cover

Power supplies



Switchable

Item no. 17243000
LED power supply 24 V DC, 120 W, switchable
 For operation up to 5,000 mm (page 534)



Dimmable

Item no. 17528000
White light radio controller
 for controlling single-color LED modules in the white light range
 Page 543



Dimmable

Item no. 17231000
LED power supply 24 V DC, 75 W, dimmable phase section
 For operation up to 5,000 mm (page 535)

You will find additional power supplies and controllers from page 530 onwards.

QualityFlex BB-Flex RGBW, 5 m, 14.4 W/m

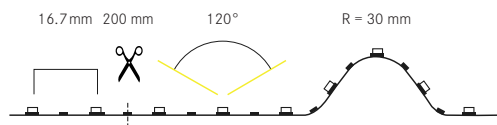

	24 VDC		14.4 W/m		CRI > 80		5,000 mm		60/m		16.7mm		dimmable
	-10 to +40 °C		IP00										

NEW

Electrical data

LED circuit board:	SMD-LED 5050
Power consumption:	14.4 W/m
Number of LEDs per meter:	60
Rated voltage:	24 VDC
Protection class:	III
Ambient temperature:	-10 to +40 °C
Control:	Negative (5-core)

Photometric data

Color rendering index: CRI > 90 at 3000 K

Light technical data

Beam angle: 120°

Service life:

Service life: L80/B10: 50,000 h
L70/B50: > 50,000 h

Mechanical data

Length of the board:	5,000 mm
Maximum module length:	5,000 mm
Pitch dimension:	200 mm
Smallest bending radius:	30 mm
Short pitch:	16.7 mm
Connection cable:	2 x 350 mm
Self-adhesive:	yes

For heat dissipation, it is absolutely necessary to mount on aluminum profiles.

For an optimum price/performance ratio, we recommend using the BB profiles from page 282 onwards.

Please refer to the profile overview on the right side for more profiles.

* Special product: Caution! The product with the red, green or blue Color temperature is a special product. This product with these Color temperatures is used for colorful illumination. The spectral distribution of the light is used to change the appearance of illuminated scenes or illuminated objects in addition to making them visible. The product is not intended for use in other applications. The special product is not suitable for room lighting in households.

Key features of the products

- Dynamic color accents in red, green, blue and white.
- Suitable for indoor areas (IP00).
- Optimal for colorful accentuation in residential areas or restaurant industry.
- Decorative illumination and accent lighting of light covers, linear applications and backlighting.
- Compatible with our 4-channel, 24 V DC controllers, RGBW.

Variants of LED flex boards



Item no.	Price in €	Color temperature	Luminous flux/m	EEK Spectrum A-G	Dimensions [W x H]
38204002	179.00	3000 K	Approximately 650 lm	F	12 x 2.1 mm
		Red	Approximately 69 lm		
		Green	Approximately 158 lm		
		Blue	Approximately 40 lm		

IP00 Uncoated LED flex board for indoor application in dry areas. Do not wipe with a damp cloth.



Profile overview

Surface-mounted profiles



Recessed profiles

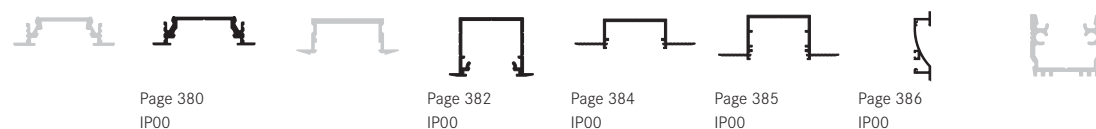

Surface-mounted corner profiles



Special profiles

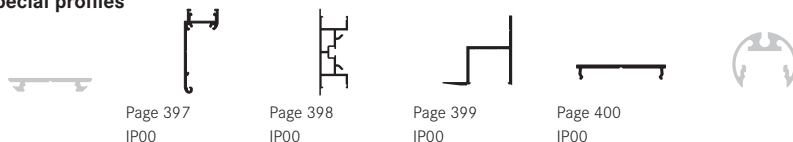

Based on the flex board with protection class IP00 in combination with an opal cover:

- Homogeneous lighting pattern is possible, ■ LED points are visible, no homogeneous lighting pattern, ■ cannot be combined with the flex board
- * = a homogeneous light line is only possible in combination with a high cover

Power supplies



Switchable

Item no. 17243000
LED power supply 24 V DC,
120 W, switchable
 For operation up to 5,000 mm
 (page 534)



Dimmable

Item no. 18223000
RGBW wireless technology control
 For controlling the RGBW LED
 modules in colored and white light.
 Page 546

**You will find additional
 power supplies and
 controllers from
 page 530 onwards.**

BB surface-mounted profile, flat

NEW

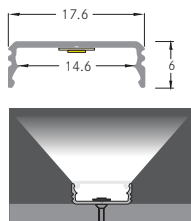

Advantages of surface-mounted profile:

- Flat, economic surface-mounted profile.
- Profile and corresponding covers are available in lengths of 1 meter, 2 meters and 3 meters.
- Optimum heat dissipation for durable illumination.

Finished length

Item no.	Lengths	Color	Price in €
53380261	1,000 mm	Aluminum anodized	6.80
53380262	2,000 mm	Aluminum anodized	12.90
53380263	3,000 mm	Aluminum anodized	20.60

Flex-click cover: PC

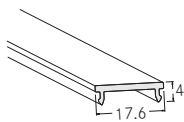

Finished length

Item no.	Lengths	Color	Price in €
53489001	1,000 mm	Transparent	4.30
53489071	1,000 mm	Opal	4.30
53489002	2,000 mm	Transparent	8.70
53489072	2,000 mm	Opal	8.70
53489003	3,000 mm	Transparent	13.80
53489073	3,000 mm	Opal	13.80

Bracket set



Item no.	Color	Price in €
53040000	Aluminum	2.20

Comprising 2 brackets.

End caps set



Item no.	Color	Price in €
53038260	Silver	1.70

BB surface-mounted profile, high

NEW

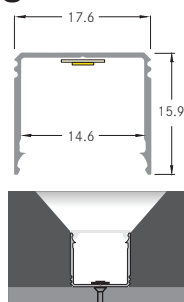
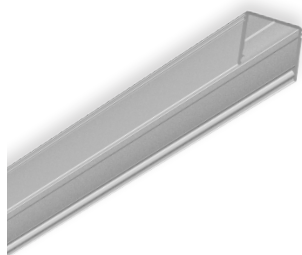

Advantages of surface-mounted profile:

- High, economic surface-mounted profile.
- Profile and corresponding covers are available in lengths of 1 meter, 2 meters and 3 meters.
- Optimum heat dissipation for durable illumination.

Finished length

Item no.	Lengths	Color	Price in €
53381261	1,000 mm	Aluminum anodized	11.40
53381262	2,000 mm	Aluminum anodized	21.20
53381263	3,000 mm	Aluminum anodized	34.00

Flex-click cover: PC

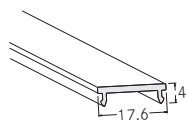

Finished length

Item no.	Lengths	Color	Price in €
53489001	1,000 mm	Transparent	4.30
53489071	1,000 mm	Opal	4.30
53489002	2,000 mm	Transparent	8.70
53489072	2,000 mm	Opal	8.70
53489003	3,000 mm	Transparent	13.80
53489073	3,000 mm	Opal	13.80

Bracket set



Item no.	Color	Price in €
53040000	Aluminum	2.20

Comprising 2 brackets.

End caps set



Item no.	Color	Price in €
53039260	Silver	2.50

BB surface-mounted corner profile

NEW

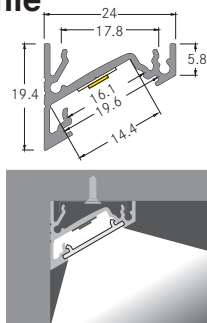

Advantages of surface-mounted corner profile:

- Simple surface-mounted corner profile.
- Profile and corresponding covers are available in lengths of 1 meter, 2 meters and 3 meters.
- Optimum heat dissipation for durable illumination.

Finished length

Item no.	Lengths	Color	Price in €
53385261	1,000 mm	Aluminum anodized	11.40
53385262	2,000 mm	Aluminum anodized	22.00
53385263	3,000 mm	Aluminum anodized	32.90

Flex-click cover: PC

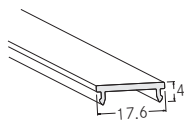

Finished length

Item no.	Lengths	Color	Price in €
53489001	1,000 mm	Transparent	4.30
53489071	1,000 mm	Opal	4.30
53489002	2,000 mm	Transparent	8.70
53489072	2,000 mm	Opal	8.70
53489003	3,000 mm	Transparent	13.80
53489073	3,000 mm	Opal	13.80

Bracket set

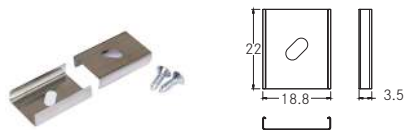

Item no.	Color	Price in €
53040000	Silver	2.20

Comprising 2 brackets.

End caps set

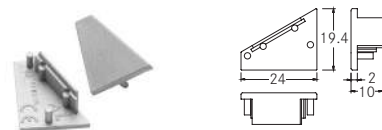

Item no.	Color	Price in €
53037260	Silver	1.60

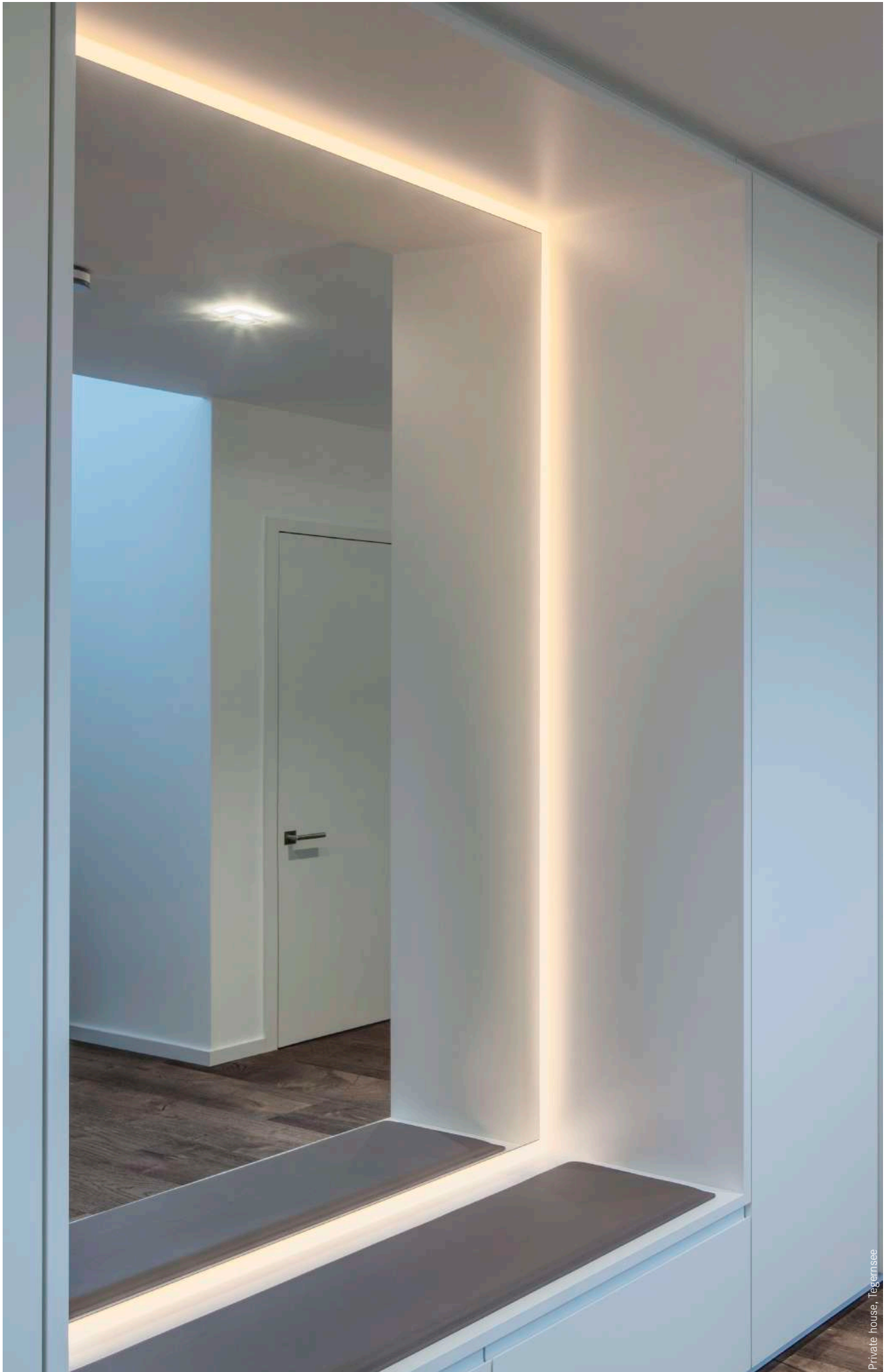

Private house, Tegernsee

QualityFlex BB-Set

5 m, 4.8 W / m

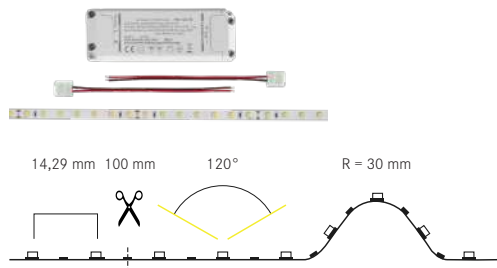

Electrical data of the LED flex board

LED circuit board:	SMD-LED 2835
Power consumption:	4.8 W/m
Number of LEDs per meter:	70
Rated voltage:	24 VDC
Protection class:	III
Ambient temperature:	-10 to +40 °C

Photometric data

Color rendering index:	CRI > 80
Efficiency:	102 lm/W at IP00, 3100 K

Light technical data

Beam angle:	120°
-------------	------

Service life:

Service life:	L80/B10: 50,000 h L70/B50: > 50,000 h ta: 25 °C
---------------	---

Mechanical data

Length of the board:	5,000 mm
Maximum module length:	5,000 mm
Pitch dimension:	100 mm
Smallest bending radius:	30 mm
Short pitch:	14.29 mm
Connection cable:	2 x 350 mm
Self-adhesive:	yes

For heat dissipation, it is absolutely necessary to mount on aluminum profiles.

Data of the 25-W power supply

Input voltage:	220 - 240 VAC, 50/60 Hz
Output voltage:	24 V DC ±5%
Input current:	typ. 0.14 A
Output current:	maximum 1.05 A
Nominal power:	25 W
Ambient temperature:	-20 to +45 °C
Housing temperature (tc):	maximum 85 °C
Dimensions (LxWxH):	126 x 42.5 x 21.5 mm
Line cross-section:	0.5... 1.5 m ²



Key features of the products

- The complete set comprises an LED flex board, a power supply and a connection cable.
- Pre-selected range.
- Low configuration cost.
- Quick illumination solution for private living areas and decorative illumination.
- Usage in dry indoor areas (IP00).
- Delivery length of 5,000 mm with a pitch of 100 mm.
- Complementary profile set for ready-made lighting solution.



Variants of LED flex boards

Item no.	Price in €	Color temperature	Luminous flux/m	EELC Spectrum A-G	Dimensions [W x H]
15291027 NEW	79.00	2700 K	Approximately 470 lm	F	8 x 1.5 mm
15291003	79.00	3100 K	Approximately 490 lm	E	8 x 1.5 mm
15291004	79.00	4100 K	Approximately 510 lm	E	8 x 1.5 mm



Scope of delivery

- 1 x LED flex board 5,000 mm
- 1 x power supply 25 W
- 2 x connection cable 150 mm

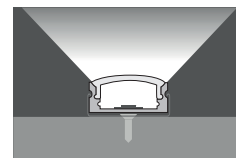
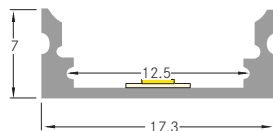

Complete set of surface-mounted aluminum profile

Item no.	Lengths	Color	Price in €
15891260	2 x 2,500 mm	Aluminum anodized	69.90

Scope of delivery

- 2 x aluminum profiles of 2,500 mm each
- 4 x end caps
- 12 x fastening clips
- 2 x opal covers of 2,500 mm each

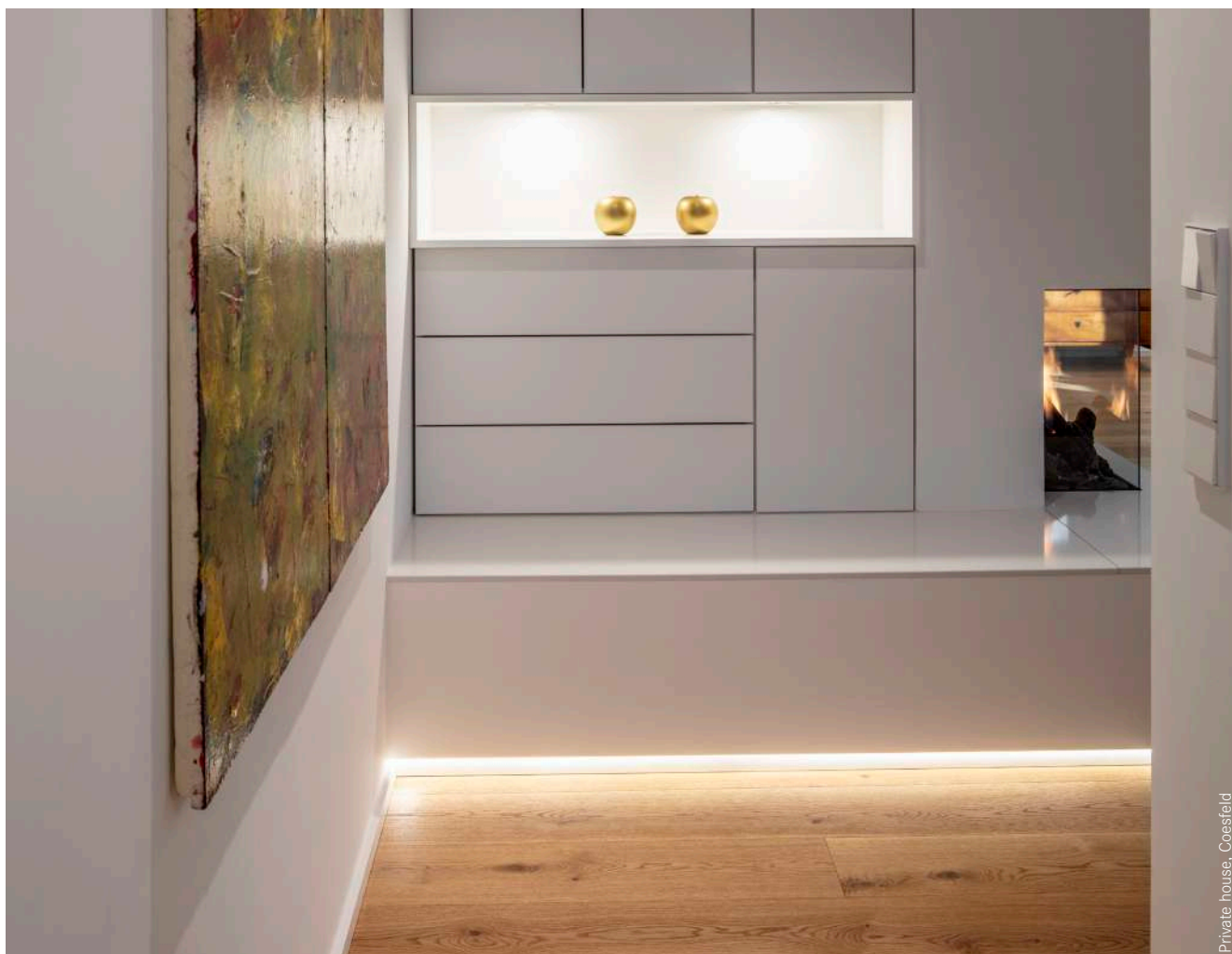

Private house, Coesfeld

QualityFlex BB-Set

5 m, 9.6 W / m

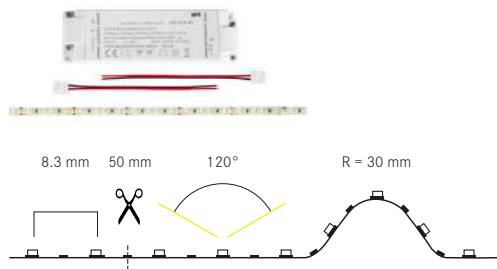

NEW

Electrical data of the LED flex board

LED circuit board:	SMD-LED 2835
Power consumption:	9.6 W/m
Number of LEDs per meter:	140
Rated voltage:	24 V DC
Protection class:	III
Ambient temperature:	-10 to +40 °C

Photometric data

Color rendering index:	CRI > 80
Efficiency:	102 lm/W at IP00, 3100 K

Light technical data

Beam angle:	120°
-------------	------

Service life:

Service life:	L80/B10: 50,000 h
	L70/B50: > 50,000 h
	ta: 25 °C

Mechanical data

Length of the board:	5,000 mm
Maximum module length:	5,000 mm
Pitch dimension:	50 mm
Smallest bending radius:	30 mm
Short pitch:	8.3 mm
Connection cable:	2 x 350 mm
Self-adhesive:	yes

For heat dissipation, it is absolutely necessary to mount on aluminum profiles.

Data of the 50-W power supply

Input voltage:	220 - 240 V AC, 50/60 Hz
Output voltage:	24 V DC ±5%
Input current:	typ. 0.3 A
Output current:	maximum 2.09 A
Nominal power:	50 W
Ambient temperature:	-20 to +45 °C
Housing temperature (tc):	maximum 85 °C
Dimensions (LxWxH):	166 x 50 x 32 mm
Line cross-section:	0.5... 1.5 m ²

Key features of the products

- The complete set comprises an LED flex board, a power supply and a connection cable.
- Pre-selected range.
- Low configuration cost.
- Quick illumination solution for private living areas and decorative illumination.
- Usage in dry indoor areas (IP00).
- Delivery length of 5,000 mm with a pitch of 50 mm.
- Complementary profile set for ready-made lighting solution.



Variants of LED flex boards

Item no.	Price in €	Color temperature	Luminous flux/m	EELC Spectrum A-G	Dimensions [W x H]
15292027 NEW	119.00	2700 K	Approximately 940 lm	F	8 x 1.5 mm
15292003	119.00	3100 K	Approximately 980 lm	E	8 x 1.5 mm
15292004	119.00	4100 K	Approximately 1,020 lm	E	8 x 1.5 mm



Scope of delivery

- 1 x LED flex board 5,000 mm
- 1 x power supply 50 W
- 2 x connection cable 150 mm

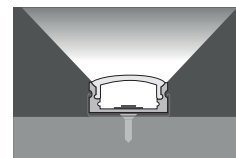
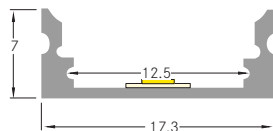

Complete set of surface-mounted aluminum profile

Item no.	Lengths	Color	Price in €
15891260	2 x 2,500 mm	Aluminum anodized	69.90

Scope of delivery

- 2 x aluminum profiles of 2,500 mm each
- 4 x end caps
- 12 x fastening clips
- 2 x opal covers of 2,500 mm each

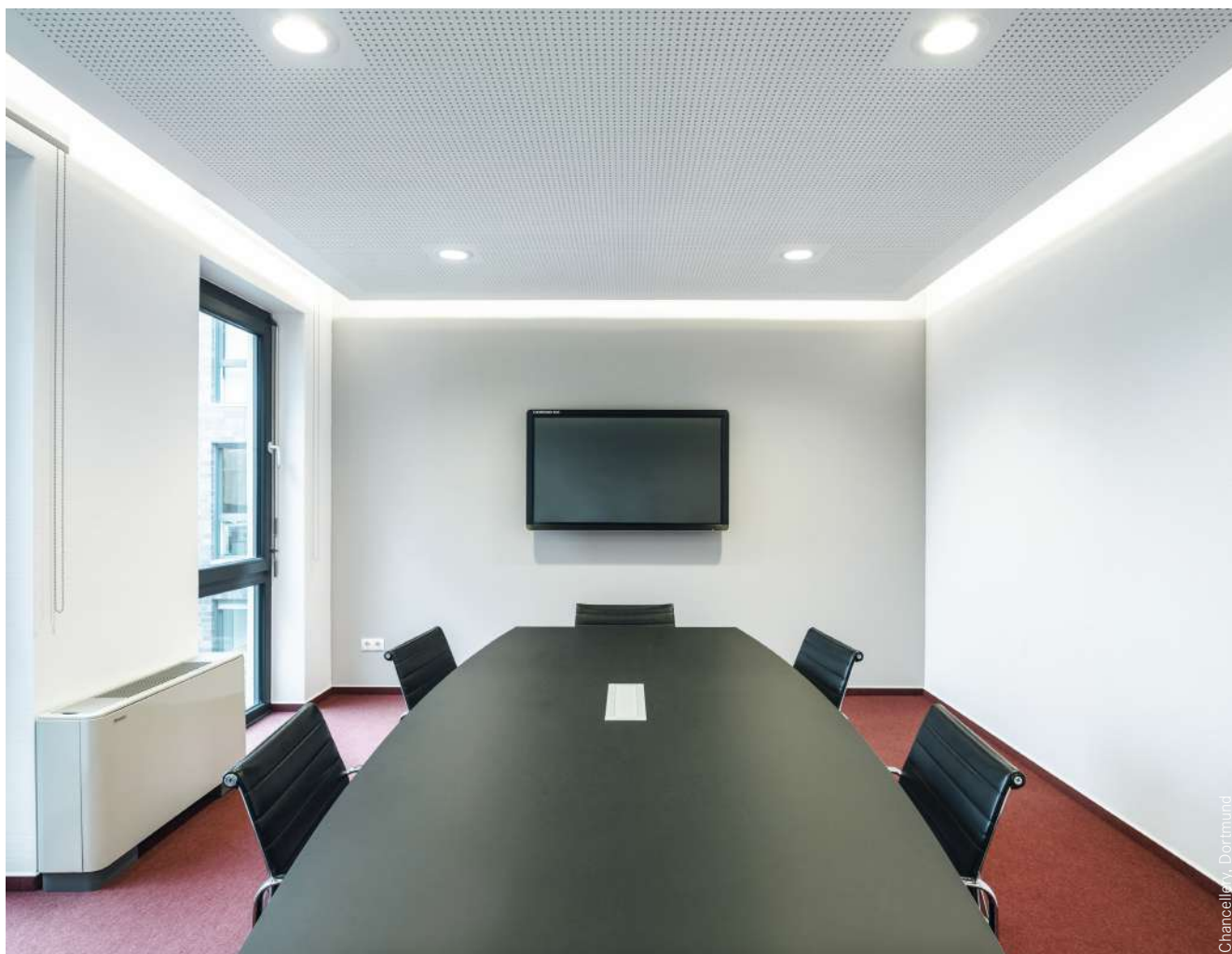

Chancellor, Dortmund



07 QualityFlex Select. Balance of color rendering and efficiency.

QualityFlex Select LED flex boards offer a good balance of color rendering and efficiency. They are ideal for use in accent and ambient lighting in the monochrome white, red, green, blue and amber ranges. Depending on the profile type, they are used in all building types and applications as recessed, surface-mounted, pendant and cove lighting.

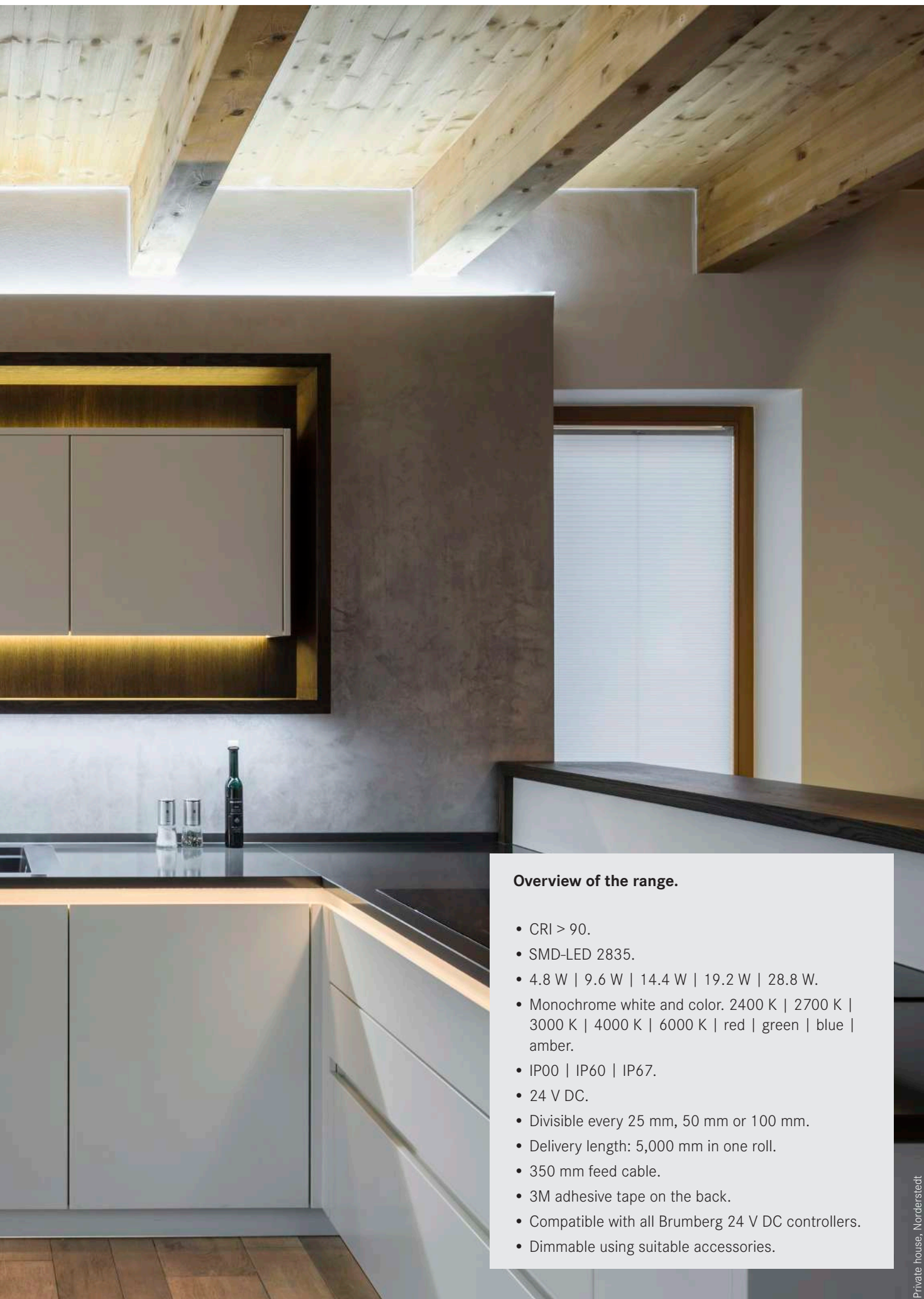

Overview of the range.

- CRI > 90.
- SMD-LED 2835.
- 4.8 W | 9.6 W | 14.4 W | 19.2 W | 28.8 W.
- Monochrome white and color. 2400 K | 2700 K | 3000 K | 4000 K | 6000 K | red | green | blue | amber.
- IP00 | IP60 | IP67.
- 24 V DC.
- Divisible every 25 mm, 50 mm or 100 mm.
- Delivery length: 5,000 mm in one roll.
- 350 mm feed cable.
- 3M adhesive tape on the back.
- Compatible with all Brumberg 24 V DC controllers.
- Dimmable using suitable accessories.

QualityFlex Select

4.8 W/m

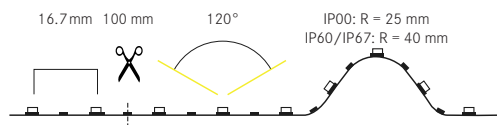

	24 VDC		4.8 W/m		CRI > 90		5,000 mm		60/m		16.7mm		dimmable
	-10 to +40 °C		IP00/ IP60		IP67								

Electrical data

LED circuit board: SMD-LED 2835
 Power consumption: 4.8 W/m
 Number of LEDs per meter: 60
 Rated voltage: 24 VDC
 Protection class: III
 Ambient temperature: -10 to +40 °C

Photometric data

Color rendering index: CRI > 90 *
 Efficiency: 83 lm/W at IP00, 3000 K

* Applicable only for white light LED flex boards.

Light technical data

Beam angle: 120°

Service life:

Service life: L80/B10: 50,000 h
 L70/B50: > 50,000 h
 ta: 25 °C

Mechanical data

Length of the board: 5,000 mm
 Maximum module length: 5,000 mm
 Pitch dimension: 100 mm
 Smallest bending radius: IP00: R = 25 mm
 IP60/IP67: R = 40 mm
 Short pitch: 16.7 mm
 Connection cable: 2 x 350 mm
 Self-adhesive: yes

For heat dissipation, it is absolutely necessary to mount on aluminum profiles.

* Special product: Caution! The product with the red, green, blue or amber Color temperature is a special product. This product with these Color temperatures is used for colorful illumination. The spectral distribution of the light is used to change the appearance of illuminated scenes or illuminated objects in addition to making them visible. The product is not intended for use in other applications. The special product is not suitable for room lighting in households.

Key features of the products

- Suitable for indoor (IP00, IP60) and outdoor (IP67) applications.
- Decorative illumination of furniture, objects and light covers.
- Length 5,000 mm with a pitch of 100 mm.
- Service life L80/B10: 50,000 hours.
- Optimum heat dissipation using suitable aluminum profiles.
- Dimmable using suitable accessories.



Variants of LED flex boards

IP00		Uncoated LED flex board for indoor application in dry areas. Do not wipe with a damp cloth.					
Item no.	Price in €	Item no.	Price in €	Color temperature	Luminous flux/m	EELK Spectrum A-G	Dimensions [W x H]
5,000 mm		100 mm					
15201024	98.00	75201024	2.80	2400 K	Approximately 390lm	F	8 x 1.4 mm
15201027	98.00	75201027	2.80	2700 K	Approximately 380lm	F	8 x 1.4 mm
15201003	98.00	75201003	2.80	3000 K	Approximately 400lm	F	8 x 1.4 mm
15201004	98.00	75201004	2.80	4000 K	Approximately 410lm	F	8 x 1.4 mm
15201005	98.00	75201005	2.80	6000 K	Approximately 430lm	F	8 x 1.4 mm
15201008	98.00	75201008	2.80	Blue	Approximately 86 lm	*	8 x 1.4 mm
15201006	98.00	75201006	2.80	Red	Approximately 113lm	*	8 x 1.4 mm
15201009	98.00	75201009	2.80	Amber	Approximately 110lm	*	8 x 1.4 mm
15201007	98.00	75201007	2.80	Green	Approximately 410lm	*	8 x 1.4 mm
		75998000	11.90	Assembly with protection class IP00			

IP60		Resistant silicone coating, insensitive to mechanical stress, wipeable.					
Item no.	Price in €	Item no.	Price in €	Color temperature	Luminous flux/m	EELK Spectrum A-G	Dimensions [W x H]
5,000 mm		100 mm					
15221027	129.00	75221027	3.70	2700 K	Approximately 360lm	F	8 x 2.8 mm
15221003	129.00	75221003	3.70	3000 K	Approximately 380lm	F	8 x 2.8 mm
15221004	129.00	75221004	3.70	4000 K	Approximately 380lm	F	8 x 2.8 mm
15221005	129.00	75221005	3.70	6000 K	Approximately 390lm	F	8 x 2.8 mm
		75999000	17.90	Assembly with enhanced protection class IP6...			

IP67		White, light-reflecting support profile with durable silicone coating. Optimum protection against mechanical shock and moisture, washable.					
Item no.	Price in €	Item no.	Price in €	Color temperature	Luminous flux/m	EELK Spectrum A-G	Dimensions [W x H]
5,000 mm		100 mm					
15271027	149.00	75271027	4.30	2700 K	Approximately 360lm	G	11 x 4.8 mm
15271003	149.00	75271003	4.30	3000 K	Approximately 380lm	F	11 x 4.8 mm
15271004	149.00	75271004	4.30	4000 K	Approximately 370lm	G	11 x 4.8 mm
15271005	149.00	75271005	4.30	6000 K	Approximately 366lm	G	11 x 4.8 mm
15271008	149.00	75271008	4.30	Blue	Approximately 73lm	*	11 x 4.8 mm
15271006	149.00	75271006	4.30	Red	Approximately 96lm	*	11 x 4.8 mm
15271009	149.00	75271009	4.30	Amber	Approximately 96lm	*	11 x 4.8 mm
15271007	149.00	75271007	4.30	Green	Approximately 349lm	*	11 x 4.8 mm
		75999000	17.90	Assembly with enhanced protection class IP6...			

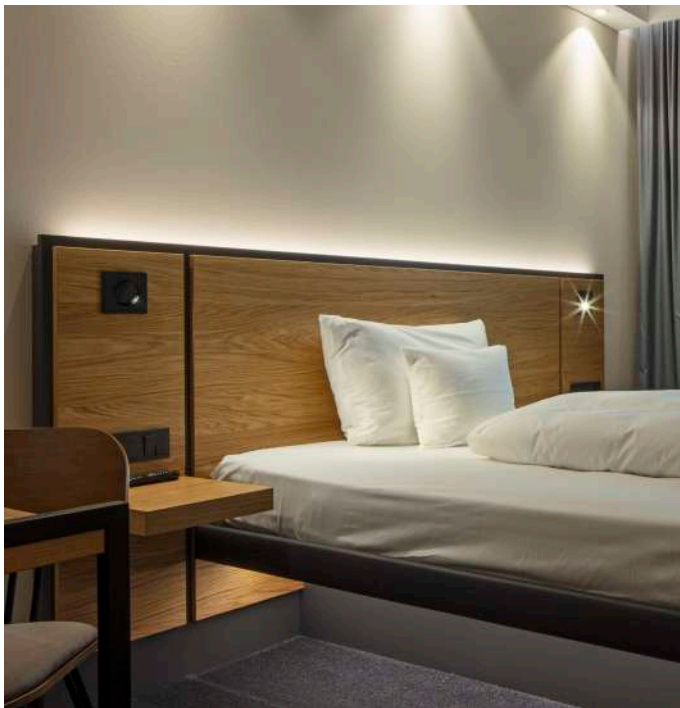

Gimm City Lounge, Ravensburg

Profile overview

Surface-mounted profiles

Page 366 IP00 IP60	Page 367 IP00 IP60 IP67	Page 368 IP00 IP60	Page 369 IP00 IP60 IP67	Page 370 IP00 IP60 IP67	Page 372 * IP00 IP60 IP67	Page 374 IP00 IP60 IP67	Page 375 IP00 IP60 IP67	Page 376 IP00 IP60 IP67

Recessed profiles

Page 379 IP00 IP60	Page 380 IP00 IP60 IP67	Page 381 IP00 IP60	Page 382 * IP00 IP60 IP67	Page 384 IP00 IP60 IP67	Page 385 IP00 IP60 IP67	Page 386 IP00 IP60 IP67	Page 387 IP00 IP60 IP67

Surface-mounted corner profiles

Page 388 IP00 IP60	Page 389 IP00 IP60	Page 390 IP00 IP60 IP67	Page 391 IP00 IP60 IP67	Page 392 IP00 IP60 IP67

Special profiles

Page 394 IP00	Page 397 IP00	Page 398 IP00	Page 399 IP00	Page 400 IP00	Page 401 IP00

Based on the flex board with protection class IP00 in combination with an opal cover:

■ Homogeneous lighting pattern is possible, ■ LED points are visible, no homogeneous lighting pattern, ■ cannot be combined with the flex board
* = a homogeneous light line is only possible in combination with a high cover

Power supplies



Switchable

Item no. 17241000
LED power supply 24 V DC, 40 W, switchable
For operation up to 5,000 mm (page 534)



Dimmable

Item no. 17528000
White light radio controller
for controlling single-color LED modules in the white light range
Page 543



Dimmable

Item no. 17230000
LED power supply 24 V DC, 30 W, dimmable phase section
For operation up to 5,000 mm (page 535)

You will find additional power supplies and controllers from page 530 onwards.

QualityFlex Select

9.6 W/m

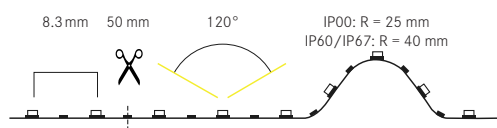

	24 VDC		9.6 W/m		CRI > 90		5,000 mm		120/m		8.3 mm		dimmable
	-10 to +40 °C		IP00/ IP60		IP67								

Key features of the products

- Suitable for indoor (IP00, IP60) and outdoor (IP67) applications.
- Decorative illumination of furniture, objects and light covers.
- Indirect illumination in residential areas.
- Length 5,000 mm with a pitch of 50 mm.
- Available in 2400 K, 2700 K, 3000 K, 4000 K and 6000 K.
- Dimmable using suitable accessories.

Electrical data

LED circuit board:	SMD-LED 2835
Power consumption:	9.6 W/m
Number of LEDs per meter:	120
Rated voltage:	24 VDC
Protection class:	III
Ambient temperature:	-10 to +40 °C

Photometric data

Color rendering index:	CRI > 90
Efficiency:	83 lm/W at IP00, 3000 K

Light technical data

Beam angle:	120°
-------------	------

Service life:

Service life:	L80/B10: 50,000 h L70/B50: > 50,000 h ta: 25 °C
---------------	---

Mechanical data

Length of the board:	5,000 mm
Maximum module length:	5,000 mm
Pitch dimension:	50 mm
Smallest bending radius:	IP00: R = 25 mm IP60/IP67: R = 40 mm
Short pitch:	8.3 mm
Connection cable:	2 x 350 mm
Self-adhesive:	yes

For heat dissipation, it is absolutely necessary to mount on aluminum profiles.

Variants of LED flex boards



IP00		Uncoated LED flex board for indoor application in dry areas. Do not wipe with a damp cloth.					
Item no.	Price in €	Item no.	Price in €	Color temperature	Luminous flux/m	EELK Spectrum A-G	Dimensions [W x H]
15202024	175.00	75202024	2.60	2400 K	Approximately 760lm	F	8 x 1.4 mm
15202027	175.00	75202027	2.60	2700 K	Approximately 770lm	F	8 x 1.4 mm
15202003	175.00	75202003	2.60	3000 K	Approximately 800lm	F	8 x 1.4 mm
15202004	175.00	75202004	2.60	4000 K	Approximately 840lm	F	8 x 1.4 mm
15202005	175.00	75202005	2.60	6000 K	Approximately 880lm	F	8 x 1.4 mm
			75998000	11.90	Assembly with protection class IP00		

IP60		Resistant silicone coating, insensitive to mechanical stress, wipeable.					
Item no.	Price in €	Item no.	Price in €	Color temperature	Luminous flux/m	EELK Spectrum A-G	Dimensions [W x H]
15222027	198.00	75222027	3.00	2700 K	Approximately 770lm	F	8 x 2.8 mm
15222003	198.00	75222003	3.00	3000 K	Approximately 770lm	F	8 x 2.8 mm
15222004	198.00	75222004	3.00	4000 K	Approximately 800lm	F	8 x 2.8 mm
15222005	198.00	75222005	3.00	6000 K	Approximately 760lm	F	8 x 2.8 mm
			75999000	17.90	Assembly with enhanced protection class IP6...		

IP67		White, light-reflecting support profile with durable silicone coating. Optimum protection against mechanical shock and moisture, washable.					
Item no.	Price in €	Item no.	Price in €	Color temperature	Luminous flux/m	EELK Spectrum A-G	Dimensions [W x H]
15272027	229.00	75272027	3.30	2700 K	Approximately 760lm	F	11 x 4.8 mm
15272003	229.00	75272003	3.30	3000 K	Approximately 760lm	F	11 x 4.8 mm
15272004	229.00	75272004	3.30	4000 K	Approximately 770lm	F	11 x 4.8 mm
15272005	229.00	75272005	3.30	6000 K	Approximately 780lm	F	11 x 4.8 mm
			75999000	17.90	Assembly with enhanced protection class IP6...		



Profile overview

Surface-mounted profiles

Page 366 IP00 IP60	Page 367 IP00 IP60 IP67	Page 368 IP00 IP60	Page 369 IP00 IP60 IP67	Page 370 IP00 IP60 IP67	Page 372 IP00 IP60 IP67	Page 374 IP00 IP60 IP67	Page 375 IP00 IP60 IP67	Page 376 IP00 IP60 IP67

Recessed profiles

Page 379 IP00 IP60	Page 380 IP00 IP60 IP67	Page 381 IP00 IP60	Page 382 IP00 IP60 IP67	Page 384 IP00 IP60 IP67	Page 385 IP00 IP60 IP67	Page 386 IP00 IP60 IP67	Page 387 IP00 IP60 IP67

Surface-mounted corner profiles

Page 388 IP00 IP60	Page 389 IP00 IP60	Page 390 IP00 IP60 IP67	Page 391 IP00 IP60 IP67	Page 392 IP00 IP60 IP67

Special profiles

Page 394 IP00	Page 397 IP00	Page 398 IP00	Page 399 IP00	Page 400 IP00	Page 401 IP00

Based on the flex board with protection class IP00 in combination with an opal cover:

■ Homogeneous lighting pattern is possible, ■ LED points are visible, no homogeneous lighting pattern, ■ cannot be combined with the flex board
 * = a homogeneous light line is only possible in combination with a high cover

Power supplies



Switchable

Item no. 17242000
LED power supply 24 V DC, 60 W, switchable
 For operation up to 5,000 mm (page 534)



Dimmable

Item no. 17528000
White light radio controller
 for controlling single-color LED modules in the white light range
 Page 543



Dimmable

Item no. 17231000
LED power supply 24 V DC, 75 W, dimmable phase section
 For operation up to 5,000 mm (page 535)

You will find additional power supplies and controllers from page 530 onwards.

QualityFlex Select

14.4 W/m

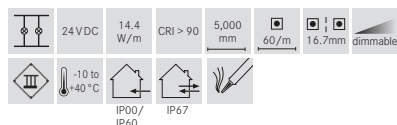
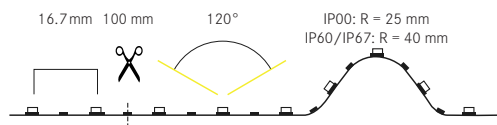

Electrical data

LED circuit board:	SMD-LED 5050
Power consumption:	14.4 W/m
Number of LEDs per meter:	60
Rated voltage:	24 VDC
Protection class:	III
Ambient temperature:	-10 to +40 °C

Photometric data

Color rendering index:	CRI > 90
Efficiency:	88 lm/W at IP00, 3000 K

Light technical data

Beam angle:	120°
-------------	------

Service life:

Service life:	L80/B10: 50,000 h L70/B50: > 50,000 h ta: 25 °C
---------------	---

Mechanical data

Length of the board:	5,000 mm
Maximum module length:	5,000 mm
Pitch dimension:	100 mm
Smallest bending radius:	IP00: R = 25 mm IP60/IP67: R = 40 mm
Short pitch:	16.7 mm
Connection cable:	2 x 350 mm
Self-adhesive:	yes

For heat dissipation, it is absolutely necessary to mount on aluminum profiles.

Key features of the products

- Suitable for indoor (IP00, IP60) and outdoor (IP67) applications.
- Direct illumination of working areas (e.g.: in a kitchen).
- Indirect illumination in residential areas.
- Length 5,000 mm with a pitch of 100 mm.
- Available in 2700 K, 3000 K, 4000 K and 6000 K in IP00, IP60 & IP67.
- Dimmable using suitable accessories.

Variants of LED flex boards



IP00		Uncoated LED flex board for indoor application in dry areas. Do not wipe with a damp cloth.					
Item no. 5,000 mm	Price in €	Item no. 100 mm	Price in €	Color tempera- ture	Luminous flux/m	EEK Spectrum A-G	Dimensions [W x H]
15203027	198.00	75203027	5.50	2700 K	Approximately 1,260 lm	F	10 x 2.2 mm
15203003	198.00	75203003	5.50	3000 K	Approximately 1,280 lm	F	10 x 2.2 mm
15203004	198.00	75203004	5.50	4000 K	Approximately 1,300 lm	F	10 x 2.2 mm
15203005	198.00	75203005	5.50	6000 K	Approximately 1,320 lm	F	10 x 2.2 mm
		75998000	11.90	Assembly with protection class IP00			

IP60		Resistant silicone coating, insensitive to mechanical stress, wipeable.					
Item no. 5,000 mm	Price in €	Item no. 100 mm	Price in €	Color tempera- ture	Luminous flux/m	EEK Spectrum A-G	Dimensions [W x H]
15223027	249.00	75223027	7.00	2700 K	Approximately 1,140 lm	F	10 x 3.2 mm
15223003	249.00	75223003	7.00	3000 K	Approximately 1,160 lm	F	10 x 3.2 mm
15223004	249.00	75223004	7.00	4000 K	Approximately 1,200 lm	F	10 x 3.2 mm
15223005	249.00	75223005	7.00	6000 K	Approximately 1,160 lm	F	10 x 3.2 mm
		75999000	17.90	Assembly with enhanced protection class IP6...			

IP67		White, light-reflecting support profile with durable silicone coating. Optimum protection against mechanical shock and moisture, washable.					
Item no. 5,000 mm	Price in €	Item no. 100 mm	Price in €	Color tempera- ture	Luminous flux/m	EEK Spectrum A-G	Dimensions [W x H]
15273027	279.00	75273027	7.90	2700 K	Approximately 1,140 lm	F	12.7 x 4.8 mm
15273003	279.00	75273003	7.90	3100 K	Approximately 1,140 lm	F	12.7 x 4.8 mm
15273004	279.00	75273004	7.90	4100 K	Approximately 1,160 lm	F	12.7 x 4.8 mm
15273005	279.00	75273005	7.90	6000 K	Approximately 1,160 lm	F	12.7 x 4.8 mm
		75999000	17.90	Assembly with enhanced protection class IP6...			



Private house, Kirchard

Profile overview

Surface-mounted profiles

Page 366 IP00 IP60	Page 367 IP00 IP60	Page 368 IP00 IP60	Page 369 IP00 IP60 IP67		Page 372 * IP00 IP60 IP67	Page 374 IP00 IP60 IP67	Page 375 IP00 IP60 IP67	Page 376 IP00 IP60 IP67

Recessed profiles

Page 379 IP00 IP60	Page 380 IP00 IP60 IP67		Page 382 * IP00 IP60 IP67	Page 384 IP00 IP60	Page 385 IP00 IP60 IP67	Page 386 IP00 IP60 IP67	Page 387 IP00 IP60

Surface-mounted corner profiles

Page 388 IP00 IP60		Page 390 IP00 IP60 IP67	Page 391 IP00 IP60 IP67	Page 392 IP00 IP60 IP67

Special profiles

Page 394 IP00	Page 397 IP00	Page 398 IP00	Page 399 IP00	Page 400 IP00	Page 401 IP00

Based on the flex board with protection class IP00 in combination with an opal cover:

■ Homogeneous lighting pattern is possible, ■ LED points are visible, no homogeneous lighting pattern, ■ cannot be combined with the flex board
* = a homogeneous light line is only possible in combination with a high cover

Power supplies



Switchable

Item no. 17243000
LED power supply 24 V DC, 120 W, switchable
For operation up to 5,000 mm (page 534)



Dimmable

Item no. 17528000
White light radio controller
for controlling single-color LED modules in the white light range
Page 543



Dimmable

Item no. 17231000
LED power supply 24 V DC, 75 W, dimmable phase section
For operation up to 5,000 mm (page 535)

You will find additional power supplies and controllers from page 530 onwards.

QualityFlex Select

19.2 W/m

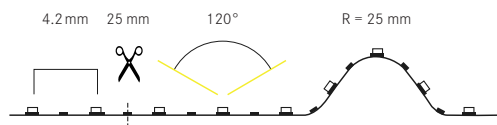

	24 VDC	19.2 W/m	CRI > 90	5,000 mm	240/m	4.2mm	dimming
	-10 to +40 °C						

Key features of the products

- Suitable for indoor applications (IP00).
- Thanks to tight LED equipment, LED equipment suitable for general lighting.
- Length 5,000 mm with a pitch of 25 mm for exceptional flexibility.
- Feed of 350 mm on both sides.
- Available in 2700 K, 3000 K, 4000 K and 6000 K.
- Dimmable using suitable accessories.

Electrical data

LED circuit board:	SMD-LED 2835
Power consumption:	19.2 W/m
Number of LEDs per meter:	240
Rated voltage:	24 VDC
Protection class:	III
Ambient temperature:	-10 to +40 °C

Photometric data

Color rendering index:	CRI > 90
Efficiency:	80 lm/W at IP00, 3000 K

Light technical data

Beam angle:	120°
-------------	------

Service life:

Service life:	L80/B10: 50,000 h
	L70/B50: > 50,000 h
	at: 25 °C

Mechanical data

Length of the board:	5,000 mm
Maximum module length:	5,000 mm
Pitch dimension:	25 mm
Smallest bending radius:	25 mm
Short pitch:	4.2 mm
Connection cable:	2 x 350 mm
Self-adhesive:	yes

For heat dissipation, it is absolutely necessary to mount on aluminum profiles.

Variants of LED flex boards



IP00		Uncoated LED flex board for indoor application in dry areas. Do not wipe with a damp cloth.					
Item no.	Price in €	Item no.	Price in €	Color temperature	Luminous flux/m	EELK Spectrum A-G	Dimensions [W x H]
15205027	298.00	75205027	2.10	2700 K	Approximately 1,600 lm	F	10 x 1.4 mm
15205003	298.00	75205003	2.10	3000 K	Approximately 1,550 lm	F	10 x 1.4 mm
15205004	298.00	75205004	2.10	4000 K	Approximately 1,630 lm	F	10 x 1.4 mm
15205005	298.00	75205005	2.10	6000 K	Approximately 1,720 lm	F	10 x 1.4 mm
		75998000	11.90	Assembly with protection class IP00			

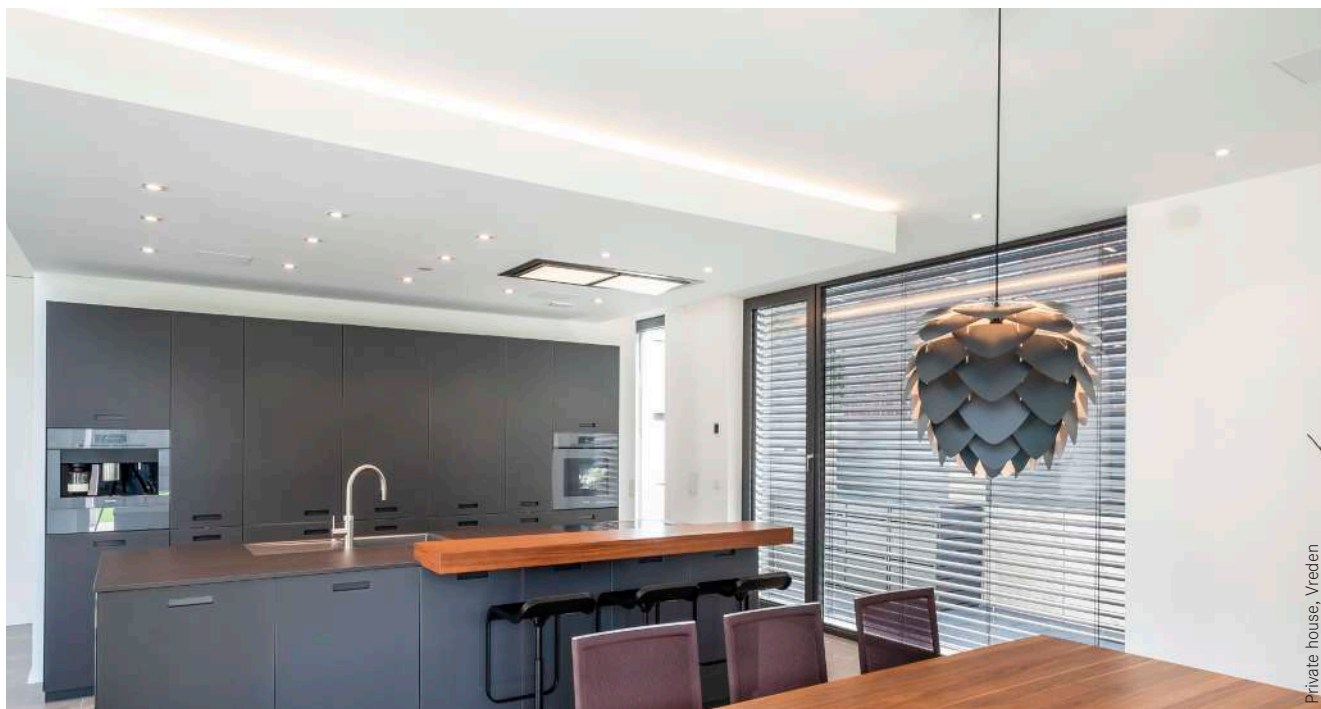

Private house, Yverden

Profile overview

Surface-mounted profiles



Recessed profiles

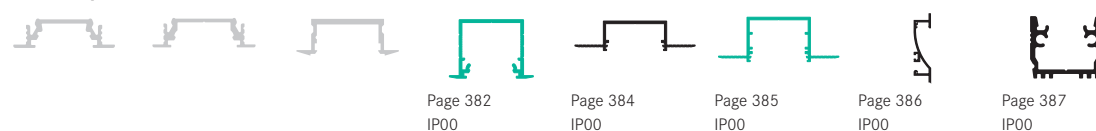

Surface-mounted corner profiles



Special profiles

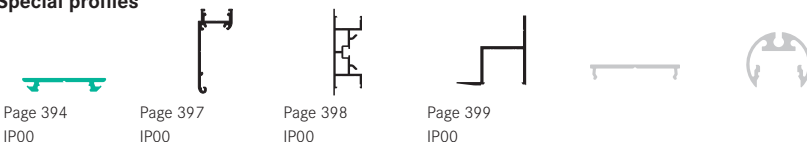

Based on the flex board with protection class IP00 in combination with an opal cover:

■ Homogeneous lighting pattern is possible, ■ LED points are visible, no homogeneous lighting pattern, ■ cannot be combined with the flex board
 * = a homogeneous light line is only possible in combination with a high cover

Power supplies



Switchable

Item no. 17243000
LED power supply 24 V DC, 120 W, switchable
 For operation up to 5,000 mm
 (page 534)



Dimmable

Item no. 17528000
White light radio controller
 for controlling single-color LED modules in the white light range
 Page 543



Dimmable

Item no. 17232000
LED power supply 24 V DC, 120 W, dimmable phase section
 For operation up to 5,000 mm
 (page 535)

You will find additional power supplies and controllers from page 530 onwards.

QualityFlex Select

28.8 W/m

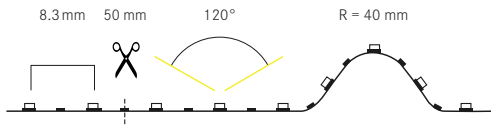

	24 VDC	28.8 W/m	CRI > 90	5,000 mm	120/m	8.3 mm	dimming
	-10 to +40 °C						

Key features of the products

- Suitable for indoor applications (IP00).
- Exceptionally powerful LED flex boards (86 lm/W) for general lighting.
- Beam angle: 120° degrees.
- Length 5,000 mm with a pitch of 50 mm.
- Available in 2700 K, 3000 K, 4000 K and 6000 K.
- Dimmable using suitable accessories.

Electrical data

LED circuit board:	SMD-LED 2835
Power consumption:	28.8 W/m
Number of LEDs per meter:	120
Rated voltage:	24 VDC
Protection class:	III
Ambient temperature:	-10 to +40 °C

Photometric data

Color rendering index:	CRI > 90
Efficiency:	86 lm/W at IP00, 3000 K

Light technical data

Beam angle:	120°
-------------	------

Service life:

Service life:	L80/B10: 50,000 h
	L70/B50: > 50,000 h
	at: 25 °C

Mechanical data

Length of the board:	5,000 mm
Maximum module length:	3,000 mm
Pitch dimension:	50 mm
Smallest bending radius:	40 mm
Short pitch:	8.3 mm
Connection cable:	2 x 350 mm
Self-adhesive:	yes

For heat dissipation, it is absolutely necessary to mount on aluminum profiles.

Variants of LED flex boards



IP00		Uncoated LED flex board for indoor application in dry areas. Do not wipe with a damp cloth.					
Item no.	Price	Item no.	Price	Color	Luminous flux/m	EEK	Dimensions
5,000 mm	in €	50 mm	in €	tempera- ture		Spectrum A-G	[W x H]
15206027	289.00	75206027	4.10	2700 K	Approximately 2,344 lm	F	10 x 1.4 mm
15206003	289.00	75206003	4.10	3000 K	Approximately 2,480 lm	F	10 x 1.4 mm
15206004	289.00	75206004	4.10	4000 K	Approximately 2,680 lm	F	10 x 1.4 mm
15206005	289.00	75206005	4.10	6000 K	Approximately 2,736 lm	F	10 x 1.4 mm
		75998000	11.90	Assembly with protection class IP00			

Feed on one side, maximum 3,000 mm

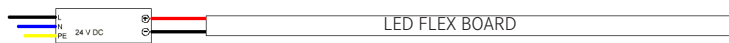

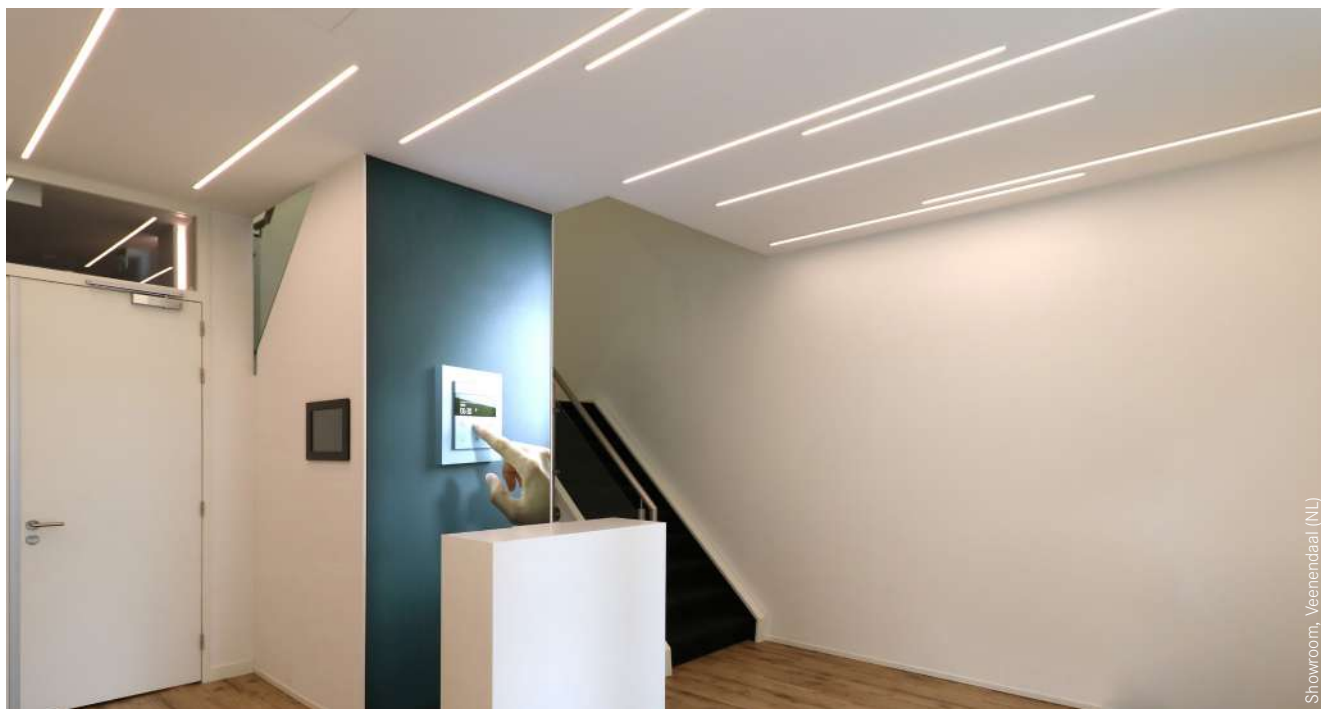

Showroom, Veenendaal (NL)

Profile overview

Surface-mounted profiles



Page 372
IP00

Recessed profiles



Page 382
IP00

Page 385
IP00

Page 386
IP00

Surface-mounted corner profiles



Page 390
IP00

Page 392
IP00

Special profiles



Based on the flex board with protection class IP00 in combination with an opal cover:

■ Homogeneous lighting pattern is possible, ■ LED points are visible, no homogeneous lighting pattern, ■ cannot be combined with the flex board
* = a homogeneous light line is only possible in combination with a high cover

Power supplies



Switchable

Item no. 17243000
LED power supply 24 V DC, 120 W, switchable
For operation up to 5,000 mm
(page 534)



Dimmable

Item no. 17528000
White light radio controller
for controlling single-color LED modules in the white light range
Page 543



Dimmable

Item no. 17232000
LED power supply 24 V DC, 120 W, dimmable phase section
For operation up to 5,000 mm
(page 535)

You will find additional power supplies and controllers from page 530 onwards.



07 QualityFlex Performance. Lighting quality all along the line.

With a delivery length of up to 30 meters, a CRI > 95 and its long service life, especially at low wattages (1.5 W - 5 W), QualityFlex Performance meets the highest demands for professional lighting tasks. This makes the LED flex boards ideal for any application, from residential to commercial to hotel and catering industry.

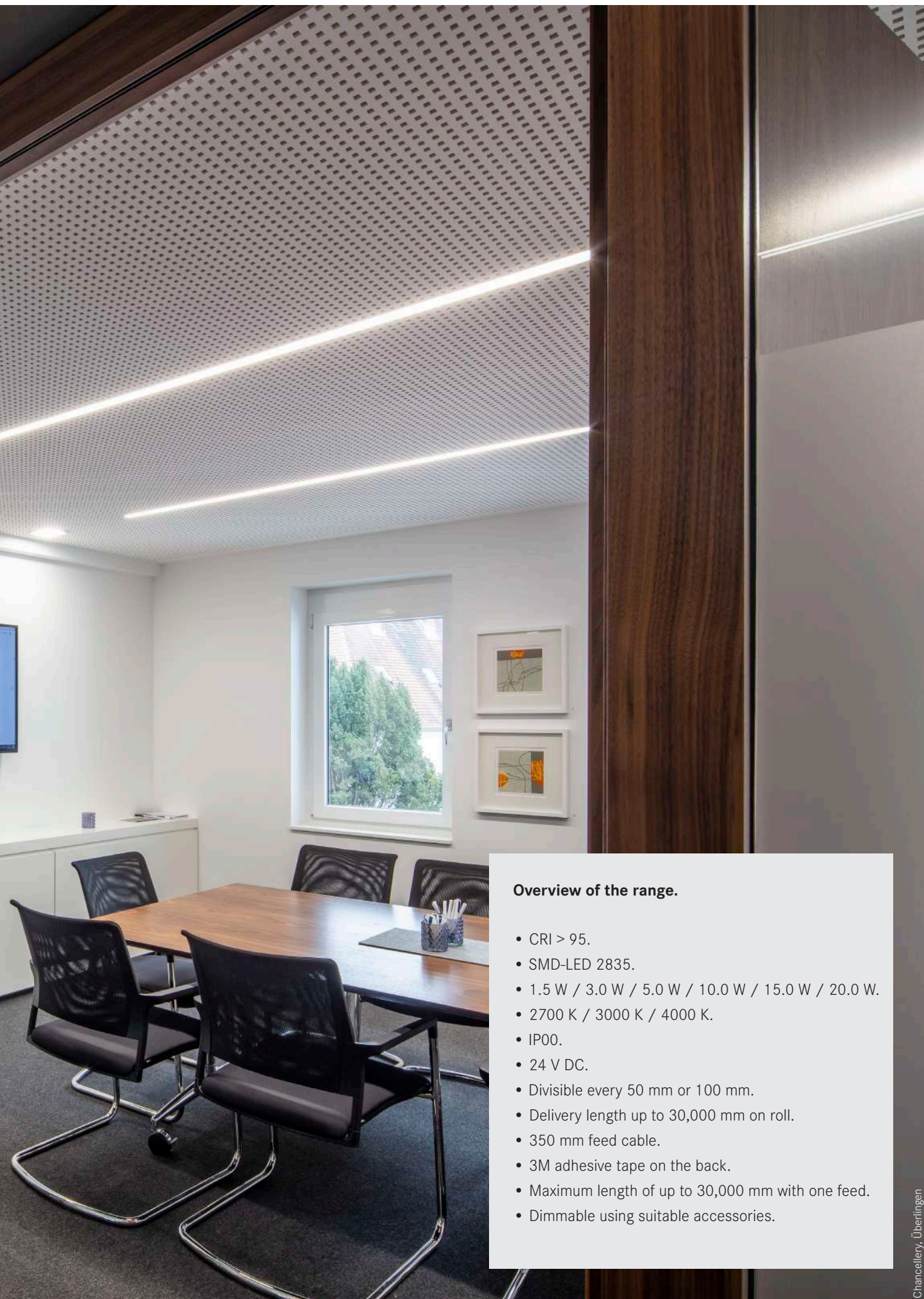

Overview of the range.

- CRI > 95.
- SMD-LED 2835.
- 1.5 W / 3.0 W / 5.0 W / 10.0 W / 15.0 W / 20.0 W.
- 2700 K / 3000 K / 4000 K.
- IP00.
- 24 V DC.
- Divisible every 50 mm or 100 mm.
- Delivery length up to 30,000 mm on roll.
- 350 mm feed cable.
- 3M adhesive tape on the back.
- Maximum length of up to 30,000 mm with one feed.
- Dimmable using suitable accessories.

QualityFlex Performance

CRI > 95, 1.5 W/m

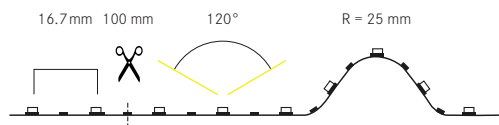

	24 VDC	1.5 W/m	CRI > 95	5,000 mm	60/m	16.7mm	dimming
	-10 to +40 °C						

NEW

Electrical data

LED circuit board:	SMD-LED 2835
Power consumption:	1.5 W/m
Number of LEDs per meter:	60
Rated voltage:	24 VDC
Protection class:	III
Ambient temperature:	-10 to +40 °C

Photometric data

Color rendering index:	CRI > 95
Efficiency:	90 lm/W at IP00, 3000 K

Light technical data

Beam angle:	120°
-------------	------

Service life:

Service life:	L80/B10: 50,000 h L70/B50: > 50,000 h at: 25 °C
---------------	---

Mechanical data

Length of the board:	5,000 mm, 30,000 mm
Maximum module length:	30,000 mm
Pitch dimension:	100 mm
Smallest bending radius:	25 mm
Short pitch:	16.7 mm
Connection cable:	2 x 350 mm
Self-adhesive:	yes

A maximum length of up to 30,000 mm is feasible with one feed.

For heat dissipation, it is absolutely necessary to mount on aluminum profiles.

Key features of the products

- Suitable for indoor applications with IP00.
- Ideal for decorative lighting and backlighting of furniture and objects.
- Super high color rendering with CRI > 95.
- Up to 30 meters feasible with one feed.
- Pitch of 100 millimeters.
- Dimmable using suitable accessories.

Variants of LED flex boards



IP00 5 m		Uncoated LED flex board for indoor application in dry areas. Do not wipe with a damp cloth.					
Item no.	Price in €	Item no.	Price in €	Color temperature	Luminous flux/m	EELK Spectrum A-G	Dimensions [W x H]
19300027	187.00	76300027	4.60	2700 K	Approximately 130 lm	F	10 x 1.4 mm
19300003	187.00	76300003	4.60	3000 K	Approximately 135 lm	F	10 x 1.4 mm
19300004	187.00	76300004	4.60	4000 K	Approximately 150 lm	F	10 x 1.4 mm
		75998000	11.90	Assembly with protection class IP00			

IP00 30 m		Uncoated LED flex board for indoor application in dry areas. Do not wipe with a damp cloth.					
Item no.	Price in €	Item no.	Price in €	Color temperature	Luminous flux/m	EELK Spectrum A-G	Dimensions [W x H]
19300127	998.00	76300027	4.60	2700 K	Approximately 130 lm	F	10 x 1.4 mm
19300103	998.00	76300003	4.60	3000 K	Approximately 135 lm	F	10 x 1.4 mm
19300104	998.00	76300004	4.60	4000 K	Approximately 150 lm	F	10 x 1.4 mm
		75998000	11.90	Assembly with protection class IP00			



Profile overview

Surface-mounted profiles

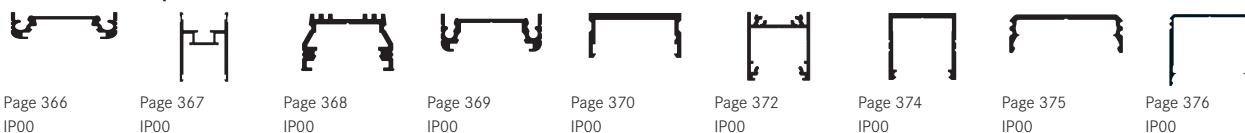

Recessed profiles

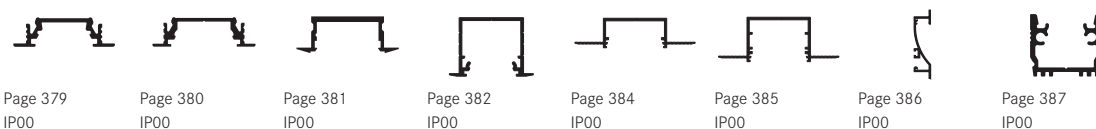

Surface-mounted corner profiles



Special profiles

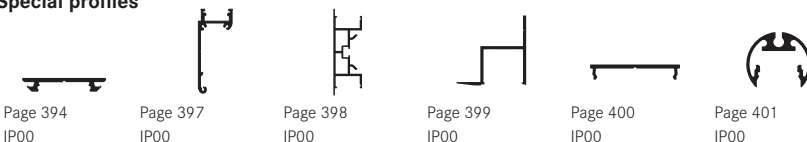

Based on the flex board with protection class IP00 in combination with an opal cover:

- Homogeneous lighting pattern is possible, ■ LED points are visible, no homogeneous lighting pattern, ■ cannot be combined with the flex board
- * = a homogeneous light line is only possible in combination with a high cover

Power supplies



Switchable

Item no. 17240000
LED power supply 24 V DC, 20 W, switchable
For operation up to 5,000 mm
(page 534)



Dimmable

Item no. 17528000
White light radio controller
for controlling single-color LED
modules in the white light range
Page 543



Dimmable

Item no. 17230000
LED power supply 24 V DC, 30 W, dimmable phase section
For operation up to 5,000 mm
(page 535)

You will find additional power supplies and controllers from page 530 onwards.

QualityFlex Performance

CRI > 95, 3 W/m

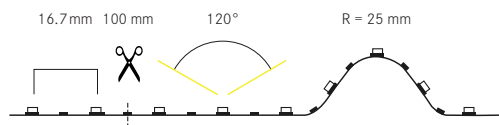

	24 VDC	3 W/m	CRI > 95	30,000 mm	60/m	16.7mm	dimming
	-10 to +40 °C						
	IP00						

Key features of the products

- Suitable for indoor applications with IP00.
- Ideal for decorative lighting and backlighting of furniture and objects.
- Super high color rendering with CRI > 95.
- Up to 30 meters feasible with one feed.
- Pitch of 100 millimeters.
- Dimmable using suitable accessories.

Electrical data

LED circuit board:	SMD-LED 2835
Power consumption:	3 W/m
Number of LEDs per meter:	60
Rated voltage:	24 VDC
Protection class:	III
Ambient temperature:	-10 to +40 °C

Photometric data

Color rendering index:	CRI > 95
Efficiency:	90 lm/W at IP00, 3000 K

Light technical data

Beam angle:	120°
-------------	------

Service life:

Service life:	L80/B10: 50,000 h L70/B50: > 50,000 h at: 25 °C
---------------	---

Mechanical data

Length of the board:	5,000 mm, 30,000
mm maximum module length:	30,000 mm
Pitch dimension:	100 mm
Smallest bending radius:	25 mm
Short pitch:	16.7 mm
Connection cable:	2 x 350 mm
Self-adhesive:	yes

A maximum length of up to 30,000 mm is feasible with one feed.

For heat dissipation, it is absolutely necessary to mount on aluminum profiles.

Variants of LED flex boards



IP00 5 m		Uncoated LED flex board for indoor application in dry areas. Do not wipe with a damp cloth.					
Item no.	Price in €	Item no.	Price in €	Color temperature	Luminous flux/m	EEK Spectrum A-G	Dimensions [W x H]
19301027	187.00	76301027	4.60	2700 K	Approximately 258 lm	F	10 x 1.4 mm
19301003	187.00	76301003	4.60	3000 K	Approximately 270 lm	F	10 x 1.4 mm
19301004	187.00	76301004	4.60	4000 K	Approximately 282 lm	F	10 x 1.4 mm
		75998000	11.90	Assembly with protection class IP00			

IP00 30 m		Uncoated LED flex board for indoor application in dry areas. Do not wipe with a damp cloth.					
Item no.	Price in €	Item no.	Price in €	Color temperature	Luminous flux/m	EEK Spectrum A-G	Dimensions [W x H]
19301327	998.00	76301027	4.60	2700 K	Approximately 258 lm	F	10 x 1.4 mm
19301303	998.00	76301003	4.60	3000 K	Approximately 270 lm	F	10 x 1.4 mm
19301304	998.00	76301004	4.60	4000 K	Approximately 282 lm	F	10 x 1.4 mm
		75998000	11.90	Assembly with protection class IP00			



Hotel VDK, Bad Fredeburg

Profile overview

Surface-mounted profiles



Recessed profiles

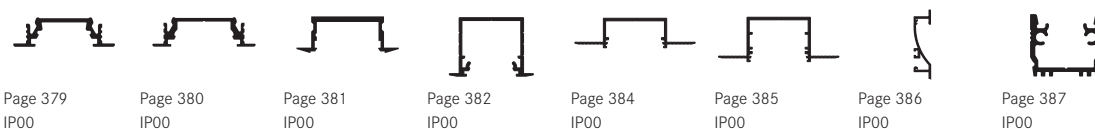

Surface-mounted corner profiles



Special profiles

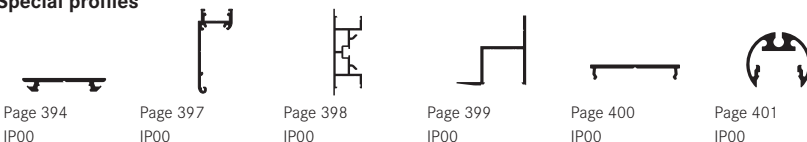

Based on the flex board with protection class IP00 in combination with an opal cover:

- Homogeneous lighting pattern is possible, ■ LED points are visible, no homogeneous lighting pattern, ■ cannot be combined with the flex board
- * = a homogeneous light line is only possible in combination with a high cover

Power supplies



Switchable

Item no. 17240000
LED power supply 24 V DC, 20 W, switchable
For operation up to 5,000 mm (page 534)



Dimmable

Item no. 17528000
White light radio controller
for controlling single-color LED modules in the white light range
Page 543



Dimmable

Item no. 17230000
LED power supply 24 V DC, 30 W, dimmable phase section
For operation up to 5,000 mm (page 535)

You will find additional power supplies and controllers from page 530 onwards.

QualityFlex Performance

CRI > 95, 5 W/m

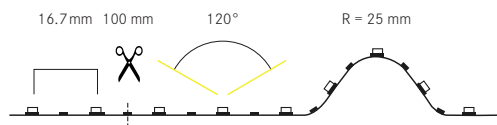

	24 VDC	5 W/m	CRI > 95	20,000 mm	60/m	16.7mm	dimmable
	-10 to +40 °C						

Key features of the products

- Super high color rendering with CRI > 95.
- Length of 20 meters feasible with one feed.
- Ideal for decorative lighting and backlighting of furniture and furnishing objects.
- Indirect illumination in residential areas.
- Suitable for indoor dry applications (IP00).
- Very long service life of 50,000 hours.
- Dimmable using suitable accessories.

Electrical data

LED circuit board:	SMD-LED 2835
Power consumption:	5 W/m
Number of LEDs per meter:	60
Rated voltage:	24 VDC
Protection class:	III
Ambient temperature:	-10 to +40 °C

Photometric data

Color rendering index:	CRI > 95
Efficiency:	86 lm/W at IP00, 3000 K

Light technical data

Beam angle:	120°
-------------	------

Service life:

Service life:	L80/B10: 50,000 h L70/B50: > 50,000 h at: 25 °C
---------------	---

Mechanical data

Length of the board:	5,000 mm, 20,000 mm
Maximum module length:	20,000 mm
Pitch dimension:	100 mm
Smallest bending radius:	25 mm
Short pitch:	16.7 mm
Connection cable:	2 x 350 mm
Self-adhesive:	yes

A maximum length of up to 20,000 mm is feasible with one feed.

For heat dissipation, it is absolutely necessary to mount on aluminum profiles.

Variants of LED flex boards



IP00 5 m		Uncoated LED flex board for indoor application in dry areas. Do not wipe with a damp cloth.					
Item no.	Price in €	Item no.	Price in €	Color temperature	Luminous flux/m	EEK Spectrum A-G	Dimensions [W x H]
19302027	199.00	76302027	4.90	2700 K	Approximately 410 lm	F	10 x 1.4 mm
19302003	199.00	76302003	4.90	3000 K	Approximately 430 lm	F	10 x 1.4 mm
19302004	199.00	76302004	4.90	4000 K	Approximately 455 lm	F	10 x 1.4 mm
		75998000	11.90	Assembly with protection class IP00			

IP00 20 m		Uncoated LED flex board for indoor application in dry areas. Do not wipe with a damp cloth.					
Item no.	Price in €	Item no.	Price in €	Color temperature	Luminous flux/m	EEK Spectrum A-G	Dimensions [W x H]
19302227	699.00	76302027	4.90	2700 K	Approximately 410 lm	F	10 x 1.4 mm
19302203	699.00	76302003	4.90	3000 K	Approximately 430 lm	F	10 x 1.4 mm
19302204	699.00	76302004	4.90	4000 K	Approximately 455 lm	F	10 x 1.4 mm
		75998000	11.90	Assembly with protection class IP00			

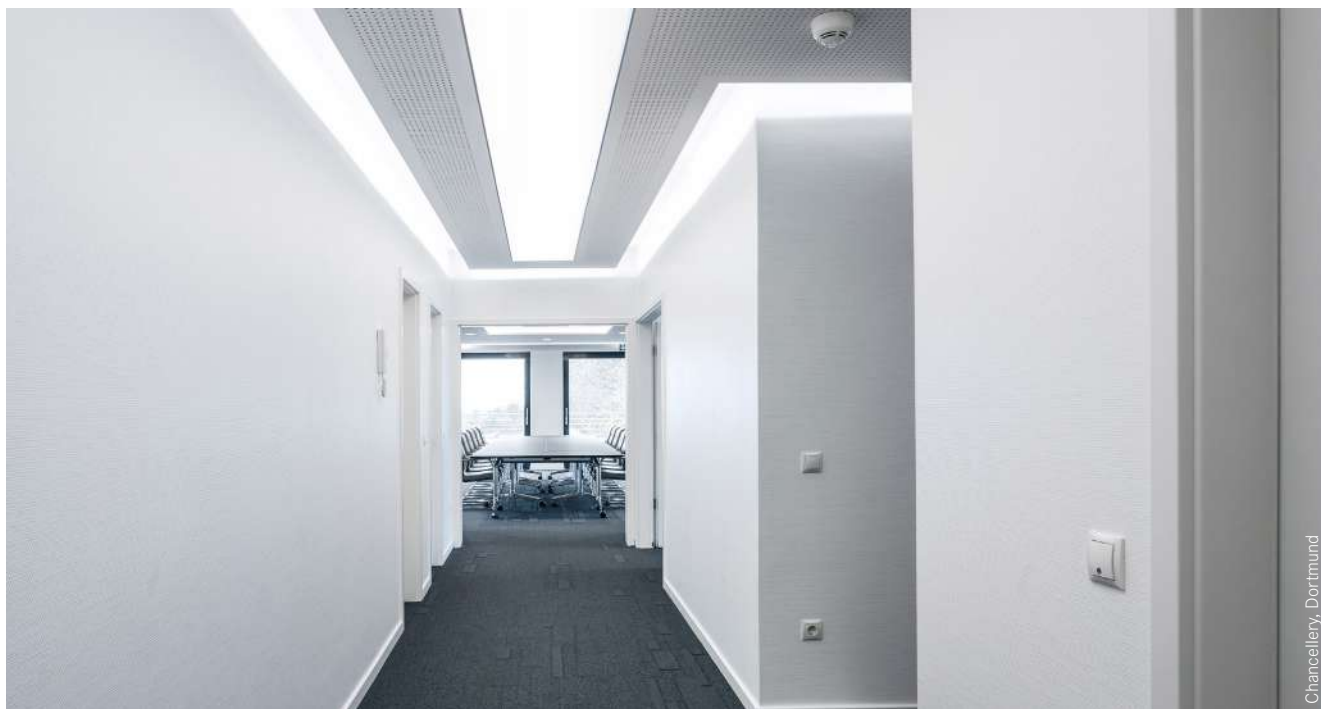

Chancellery, Dortmund

Profile overview

Surface-mounted profiles

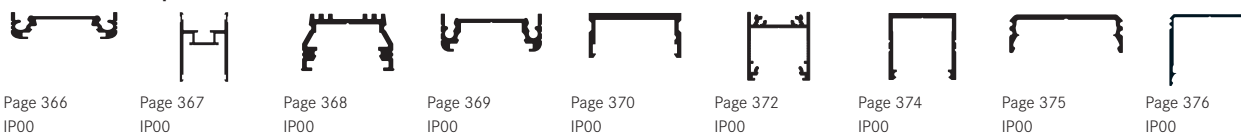

Recessed profiles

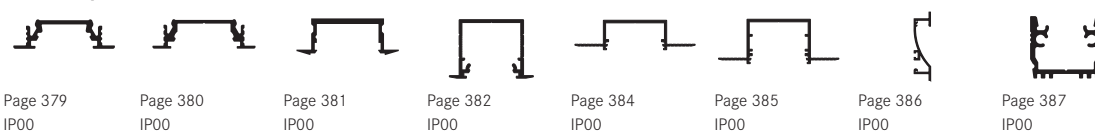

Surface-mounted corner profiles



Special profiles

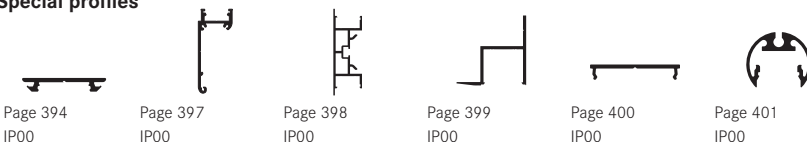

Based on the flex board with protection class IP00 in combination with an opal cover:

- Homogeneous lighting pattern is possible, ■ LED points are visible, no homogeneous lighting pattern, ■ cannot be combined with the flex board
- * = a homogeneous light line is only possible in combination with a high cover

Power supplies



Switchable

Item no. 17241000
LED power supply 24 V DC,
40 W, switchable
For operation up to 5,000 mm
(page 534)



Dimmable

Item no. 17528000
White light radio controller
for controlling single-color LED
modules in the white light range
Page 543



Dimmable

Item no. 17230000
LED power supply 24 V DC,
30 W, dimmable phase section
For operation up to 5,000 mm
(page 535)

You will find additional
power supplies and
controllers from
page 530 onwards.

QualityFlex Performance

CRI > 95, 10 W/m

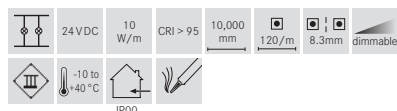
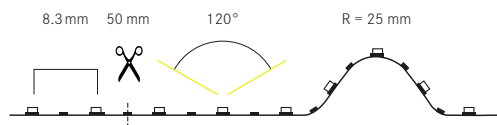

Electrical data

LED circuit board:	SMD-LED 2835
Power consumption:	10 W/m
Number of LEDs per meter:	120
Rated voltage:	24 VDC
Protection class:	III
Ambient temperature:	-10 to +40 °C

Photometric data

Color rendering index:	CRI > 95
Efficiency:	87 lm/W at IP00, 3000 K

Light technical data

Beam angle:	120°
-------------	------

Service life:

Service life:	L80/B10: 50,000 h L70/B50: > 50,000 h ta: 25 °C
---------------	---

Mechanical data

Length of the board:	5,000 mm, 10,000 mm
Maximum module length:	10,000 mm
Pitch dimension:	50 mm
Smallest bending radius:	25 mm
Short pitch:	8.3 mm
Connection cable:	2 x 350 mm
Self-adhesive:	yes

A maximum length of up to 10,000 mm is feasible with one feed.

For heat dissipation, it is absolutely necessary to mount on aluminum profiles.

Key features of the products

- Low LED spacing for optimal indirect illumination.
- Super high color rendering with CRI > 95.
- Maximum length of 10 meters feasible one feed.
- Suitable for indoor dry applications (IP00).
- Very small pitch of 50 millimeters.
- Decorative, indirect and ambient lighting in residential areas.
- Available in 2700 Kelvin, 3000 Kelvin and 4000 Kelvin.
- Dimmable using suitable accessories.

Variants of LED flex boards



IP00 5 m				Uncoated LED flex board for indoor application in dry areas. Do not wipe with a damp cloth.			
Item no.	Price in €	Item no.	Price in €	Color temperature	Luminous flux/m	EEK Spectrum A-G	Dimensions [W x H]
5,000 mm		50 mm					
19303027	308.00	76303027	3.80	2700 K	Approximately 820 lm	F	10 x 1.4 mm
19303003	308.00	76303003	3.80	3000 K	Approximately 870 lm	F	10 x 1.4 mm
19303004	308.00	76303004	3.80	4000 K	Approximately 900 lm	F	10 x 1.4 mm
		75998000	11.90	Assembly with protection class IP00			

IP00 10 m				Uncoated LED flex board for indoor application in dry areas. Do not wipe with a damp cloth.			
Item no.	Price in €	Item no.	Price in €	Color temperature	Luminous flux/m	EEK Spectrum A-G	Dimensions [W x H]
10,000 mm		50 mm					
19303127	549.00	76303027	3.80	2700 K	Approximately 820 lm	F	10 x 1.4 mm
19303103	549.00	76303003	3.80	3000 K	Approximately 870 lm	F	10 x 1.4 mm
19303104	549.00	76303004	3.80	4000 K	Approximately 900 lm	F	10 x 1.4 mm
		75998000	11.90	Assembly with protection class IP00			



Profile overview

Surface-mounted profiles

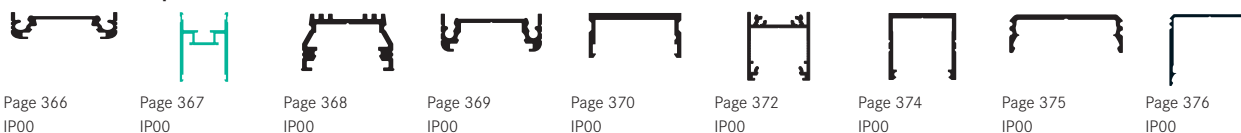

Recessed profiles

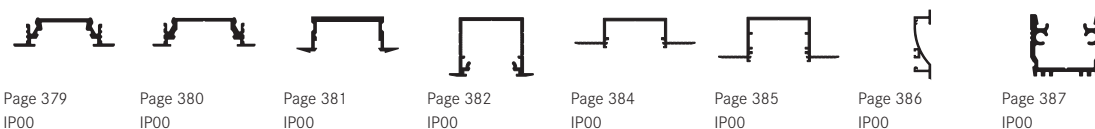

Surface-mounted corner profiles



Special profiles

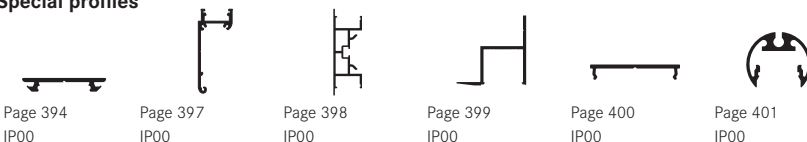

Based on the flex board with protection class IP00 in combination with an opal cover:

■ Homogeneous lighting pattern is possible, ■ LED points are visible, no homogeneous lighting pattern, ■ cannot be combined with the flex board
 * = a homogeneous light line is only possible in combination with a high cover

Power supplies



Switchable

Item no. 17242000
LED power supply 24 V DC, 60 W, switchable
 For operation up to 5,000 mm (page 534)



Dimmable

Item no. 17528000
White light radio controller
 for controlling single-color LED modules in the white light range
 Page 543



Dimmable

Item no. 17231000
LED power supply 24 V DC, 75 W, dimmable phase section
 For operation up to 5,000 mm (page 535)

You will find additional power supplies and controllers from page 530 onwards.

QualityFlex Performance

CRI > 95, 15 W/m

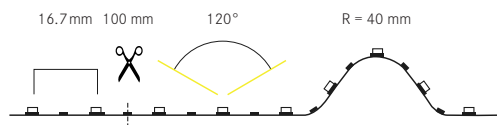

	24 VDC	15 W/m	CRI > 95	10,000 mm	60/m	16.7mm	dimmi l able
	-10 to +40 °C						

Key features of the products

- Super high color rendering with CRI > 95.
- Maximum length of 10 meters feasible one feed.
- Suitable for indoor dry applications (IP00).
- Pitch of 100 millimeters.
- High light output for indirect and ambient lighting in numerous areas of application.
- Available in 2700 Kelvin, 3000 Kelvin and 4000 Kelvin.
- Dimmable using suitable accessories.



Electrical data

LED circuit board:	SMD-LED 2835
Power consumption:	15 W/m
Number of LEDs per meter:	60
Rated voltage:	24 VDC
Protection class:	III
Ambient temperature:	-10 to +40 °C

Photometric data

Color rendering index:	CRI > 95
Efficiency:	78 lm/W at IP00, 3000 K

Light technical data

Beam angle:	120°
-------------	------

Service life:

Service life:	L80/B10: 50,000 h L70/B50: > 50,000 h at: 25 °C
---------------	---

Mechanical data

Length of the board:	5,000 mm, 10,000 mm
Maximum module length:	10,000 mm
Pitch dimension:	100 mm
Smallest bending radius:	40 mm
Short pitch:	16.7 mm
Connection cable:	2 x 350 mm
Self-adhesive:	yes

A maximum length of up to 10,000 mm is feasible with one feed.

For heat dissipation, it is absolutely necessary to mount on aluminum profiles.

Variants of LED flex boards

IP00 5 m				Uncoated LED flex board for indoor application in dry areas. Do not wipe with a damp cloth.			
Item no.	Price in €	Item no.	Price in €	Color temperature	Luminous flux/m	EEK Spectrum A-G	Dimensions [W x H]
19304027	218.00	76304027	5.40	2700 K	Approximately 1,180lm	F	10 x 1.4 mm
19304003	218.00	76304003	5.40	3000 K	Approximately 1,238lm	F	10 x 1.4 mm
19304004	218.00	76304004	5.40	4000 K	Approximately 1,180lm	F	10 x 1.4 mm
		75998000	11.90	Assembly with protection class IP00			

IP00 10 m				Uncoated LED flex board for indoor application in dry areas. Do not wipe with a damp cloth.			
Item no.	Price in €	Item no.	Price in €	Color temperature	Luminous flux/m	EEK Spectrum A-G	Dimensions [W x H]
19304127	399.00	76304027	5.40	2700 K	Approximately 1,180lm	F	10 x 1.4 mm
19304103	399.00	76304003	5.40	3000 K	Approximately 1,238lm	F	10 x 1.4 mm
19304104	399.00	76304004	5.40	4000 K	Approximately 1,180lm	F	10 x 1.4 mm
		75998000	11.90	Assembly with protection class IP00			



Finanzkanzlei, Berlin

Profile overview

Surface-mounted profiles



Recessed profiles

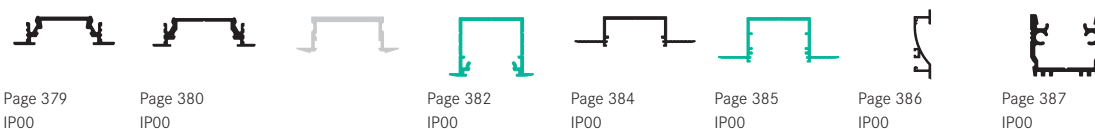

Surface-mounted corner profiles



Special profiles

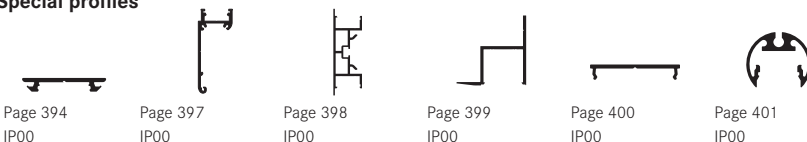

Based on the flex board with protection class IP00 in combination with an opal cover:

■ Homogeneous lighting pattern is possible, ■ LED points are visible, no homogeneous lighting pattern, ■ cannot be combined with the flex board
 * = a homogeneous light line is only possible in combination with a high cover

Power supplies



Switchable

Item no. 17243000
LED power supply 24 V DC, 120 W, switchable
 For operation up to 5,000 mm (page 534)



Dimmable

Item no. 17528000
White light radio controller
 for controlling single-color LED modules in the white light range
 Page 543



Dimmable

Item no. 17232000
LED power supply 24 V DC, 120 W, dimmable phase section
 For operation up to 5,000 mm (page 535)

You will find additional power supplies and controllers from page 530 onwards.

QualityFlex Performance

CRI > 95, 20 W/m

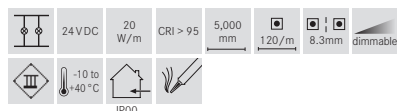
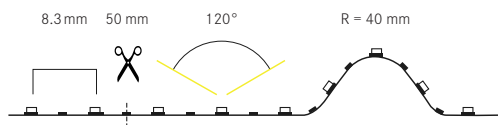

NEW

Electrical data

LED circuit board: SMD-LED 2835
 Power consumption: 20 W/m
 Number of LEDs per meter: 120
 Rated voltage: 24 VDC
 Protection class: III
 Ambient temperature: -10 to +40 °C

Photometric data

Color rendering index: CRI > 95
 Efficiency: 86 lm/W at IP00, 3000 K

Light technical data

Beam angle: 120°

Service life:

Service life: L80/B10: 50,000 h
 L70/B50: > 50,000 h at: 25 °C

Mechanical data

Length of the board: 5,000 mm
 Maximum module length: 5,000 mm
 Pitch dimension: 50 mm
 Smallest bending radius: 40 mm
 Short pitch: 8.3 mm
 Connection cable: 2 x 350 mm
 Self-adhesive: yes

A maximum length of up to 5,000 mm is feasible with one feed.

For heat dissipation, it is absolutely necessary to mount on aluminum profiles.

Key features of the products

- Super high color rendering with CRI > 95.
- Suitable for indoor dry applications (IP00).
- Very small pitch of 50 millimeters.
- Very high light output with 20 Watt per meter.
- Suitable for general lighting numerous fields of applications.
- Available in 2700 Kelvin, 3000 Kelvin and 4000 Kelvin.
- Dimmable using suitable accessories.

Variants of LED flex boards

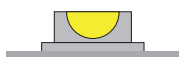

IP00 | 5 m  Uncoated LED flex board for indoor application in dry areas. Do not wipe with a damp cloth.

Item no. 5,000 mm	Price in €	Item no. 50 mm	Price in €	Color tempera- ture	Luminous flux/m	EEL Spectrum A-G	Dimensions [W x H]
19305027	349.00	76305027	5.20	2700 K	Approximately 1,660 lm	F	10 x 1.4 mm
19305003	349.00	76305003	5.20	3000 K	Approximately 1,720 lm	F	10 x 1.4 mm
19305004	349.00	76305004	5.20	4000 K	Approximately 1,800 lm	F	10 x 1.4 mm
75998000 11.90 Assembly with protection class IP00							

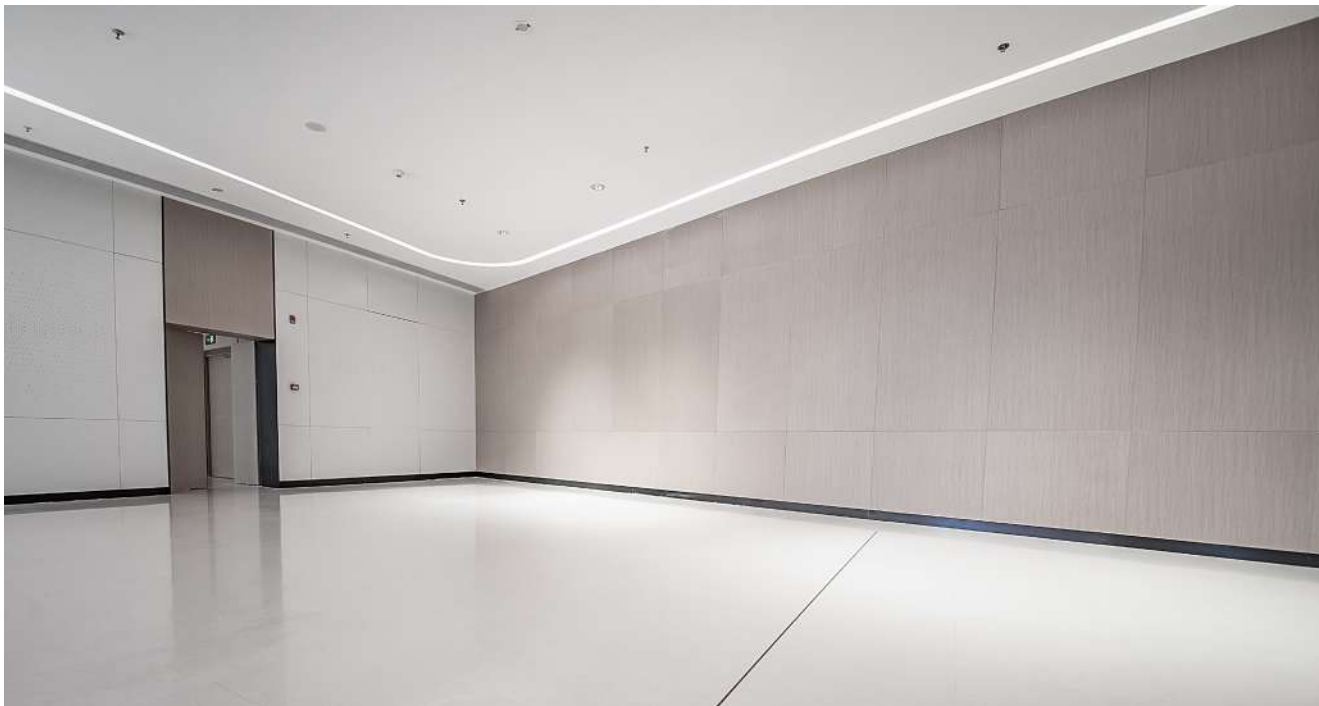

Profile overview

Surface-mounted profiles



Recessed profiles

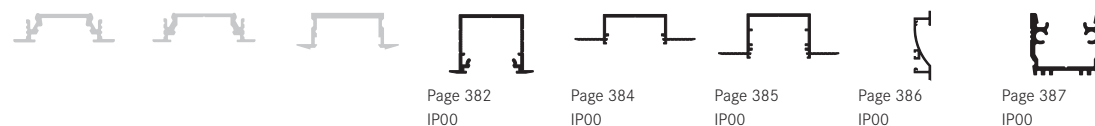

Surface-mounted corner profiles



Special profiles

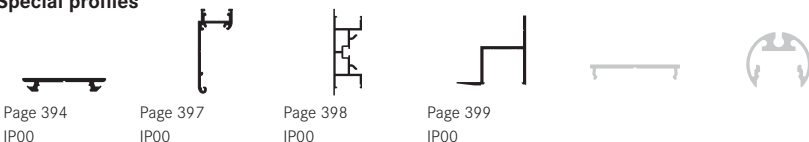

Based on the flex board with protection class IP00 in combination with an opal cover:

- Homogeneous lighting pattern is possible, ■ LED points are visible, no homogeneous lighting pattern, ■ cannot be combined with the flex board
- * = a homogeneous light line is only possible in combination with a high cover

Power supplies



Switchable

Item no. 17243000
LED power supply 24 V DC,
120 W, switchable
For operation up to 5,000 mm
(page 534)



Dimmable

Item no. 17528000
White light radio controller
for controlling single-color LED
modules in the white light range
Page 543



Dimmable

Item no. 17232000
LED power supply 24 V DC,
120 W, dimmable phase section
For operation up to 5,000 mm
(page 535)

You will find additional
power supplies and
controllers from
page 530 onwards.

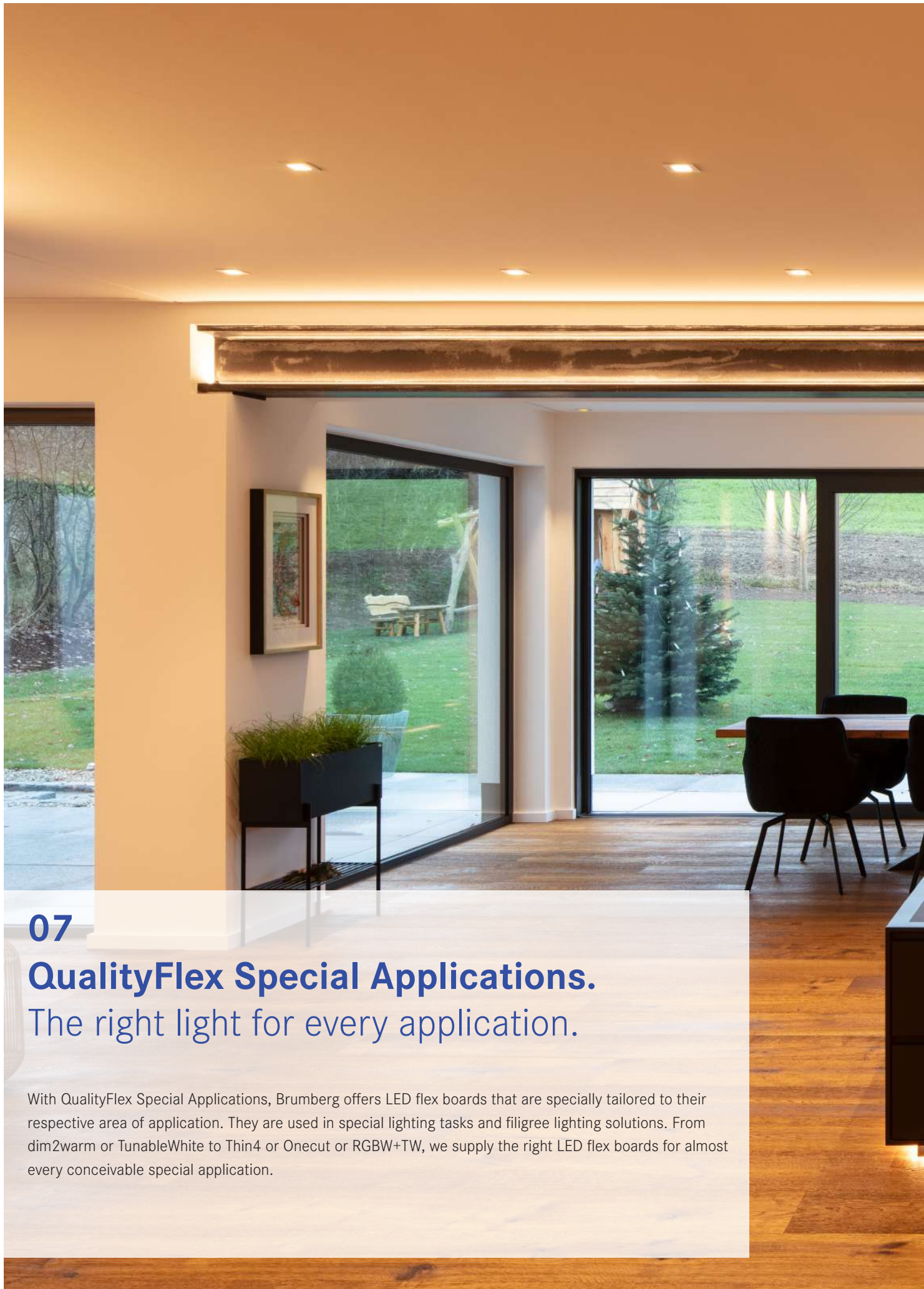

07 QualityFlex Special Applications. The right light for every application.

With QualityFlex Special Applications, Brumberg offers LED flex boards that are specially tailored to their respective area of application. They are used in special lighting tasks and filigree lighting solutions. From dim2warm or TunableWhite to Thin4 or OneCut or RGBW+TW, we supply the right LED flex boards for almost every conceivable special application.



Overview of the range.

- COB Vision: For homogeneous light.
- Dim2warm: for a dimming effect like incandescent lamps. (Dimming from 3000 Kelvin to 1800 Kelvin).
- TunableWhite: For variable color temperature control from warm to cool white light.
- Thin4: For particularly narrow fixtures (4 mm board width).
- Onecut: For light accurate to the millimeter (divisible after each LED).
- Food: For the visual highlighting of individual product groups and color-accurate product presentation of foodstuffs.
- RGB and RGBW: For atmospheric color accentuation and room solutions.
- RGB+TW: The 5-channel solution that combines RGB and TW for colored and dynamic lighting applications.

QualityFlex Special Applications

COB-Vision, 5 m, 10 W / m

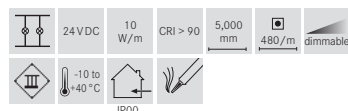
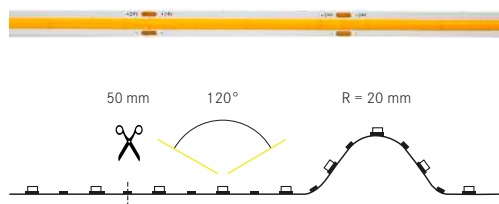

NEW

Electrical data

LED circuit board:	COB LED
Power consumption:	10 W/m
Number of LEDs per meter:	480
Rated voltage:	24 VDC
Protection class:	III
Ambient temperature:	-10 to +40 °C

Photometric data

Color rendering index:	CRI > 90
Color consistency:	SDCM < 3
Efficiency:	100 lm/W at IP00, 3000 K

Light technical data

Beam angle:	120°
-------------	------

Service life:

Service life:	L80/B10: 50,000 h L70/B50: > 50,000 h at: 25 °C
---------------	---

Mechanical data

Length of the board:	5,000 mm
Maximum module length:	5,000 mm
Pitch dimension:	50 mm
Smallest bending radius:	20 mm
Connection cable:	2 x 500 mm
Self-adhesive:	yes

For heat dissipation, it is absolutely necessary to mount on aluminum profiles.

Key features of the products

- High color rendering with CRI > 90.
- Chip-on-Board LED equipment for homogeneous lighting pattern.
- Continuous light emission along the length of the board.
- Ideal for indirect and decorative illumination.
- Color temperature 2700 K, 3000 K, 4000 K.
- Suitable for indoor dry applications.
- Pitch of 50 millimeters.
- Color temperature: Monochrome white.
- Dimmable using suitable accessories.

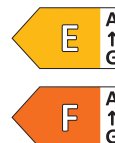

Variants of LED flex boards

IP00		Uncoated LED flex board for indoor application in dry areas. Do not wipe with a damp cloth.					
Item no.	Price in €	Item no.	Price in €	Color temperature	Luminous flux/m	EELK Spectrum A-G	Dimensions [W x H]
15317027	198.00	75317027	2.75	2700 K	Approximately 950 lm	F	10 x 2 mm
15317003	198.00	75317003	2.75	3000 K	Approximately 1,000 lm	F	10 x 2 mm
15317004	198.00	75317004	2.75	4000 K	Approximately 1,105 lm	E	10 x 2 mm
		75998000	11.90	Assembly with protection class IP00			

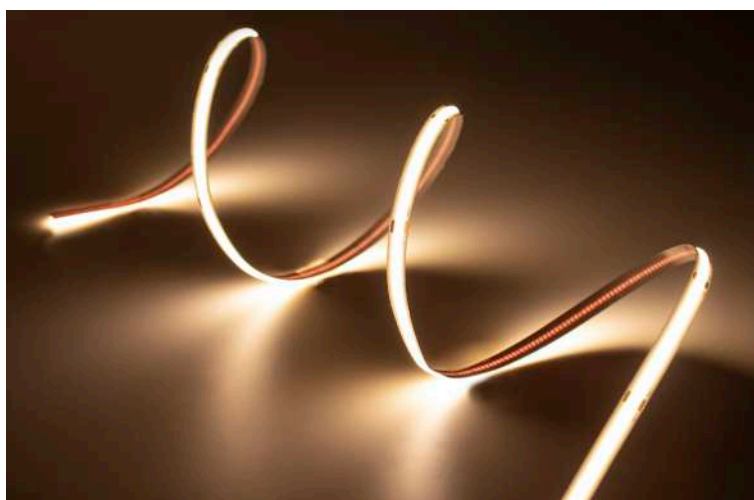

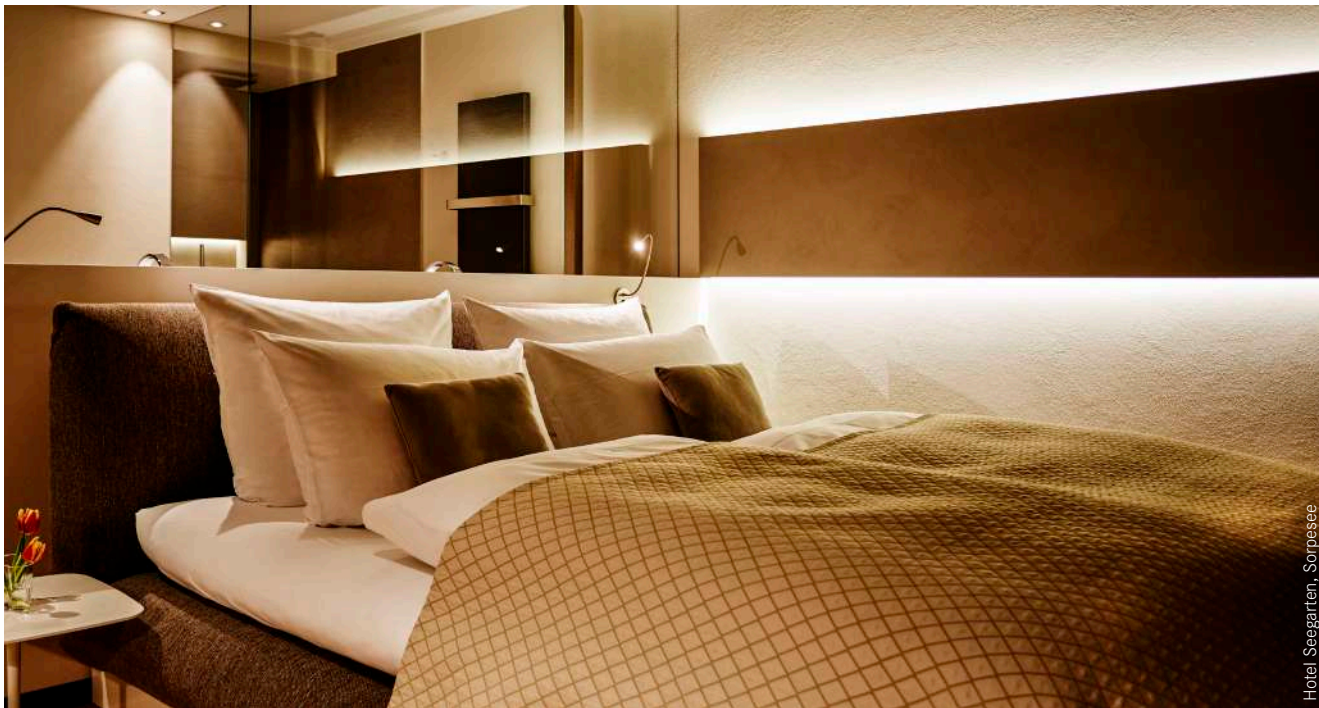

Hotel Seegarten, Sorpesee

Profile overview

Surface-mounted profiles

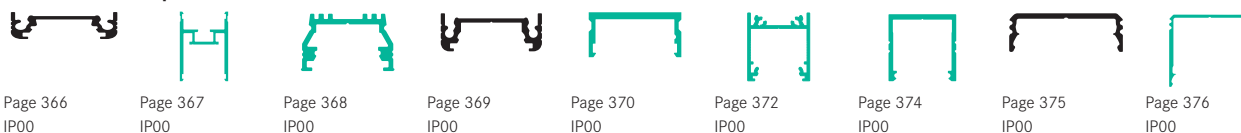

Recessed profiles

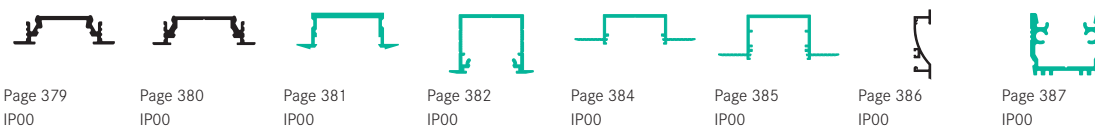

Surface-mounted corner profiles



Special profiles



Based on the flex board with protection class IP00 in combination with an opal cover:

■ Homogeneous lighting pattern is possible, ■ LED points are visible, no homogeneous lighting pattern, ■ cannot be combined with the flex board
 * = a homogeneous light line is only possible in combination with a high cover

Power supplies



Switchable

Item no. 17242000
LED power supply 24 V DC, 60 W, switchable
 For operation up to 5,000 mm (page 534)



Dimmable

Item no. 17528000
White light radio controller
 for controlling single-color LED modules in the white light range
 Page 543



Dimmable

Item no. 17231000
LED power supply 24 V DC, 75 W, dimmable phase section
 For operation up to 5,000 mm (page 535)

You will find additional power supplies and controllers from page 530 onwards.

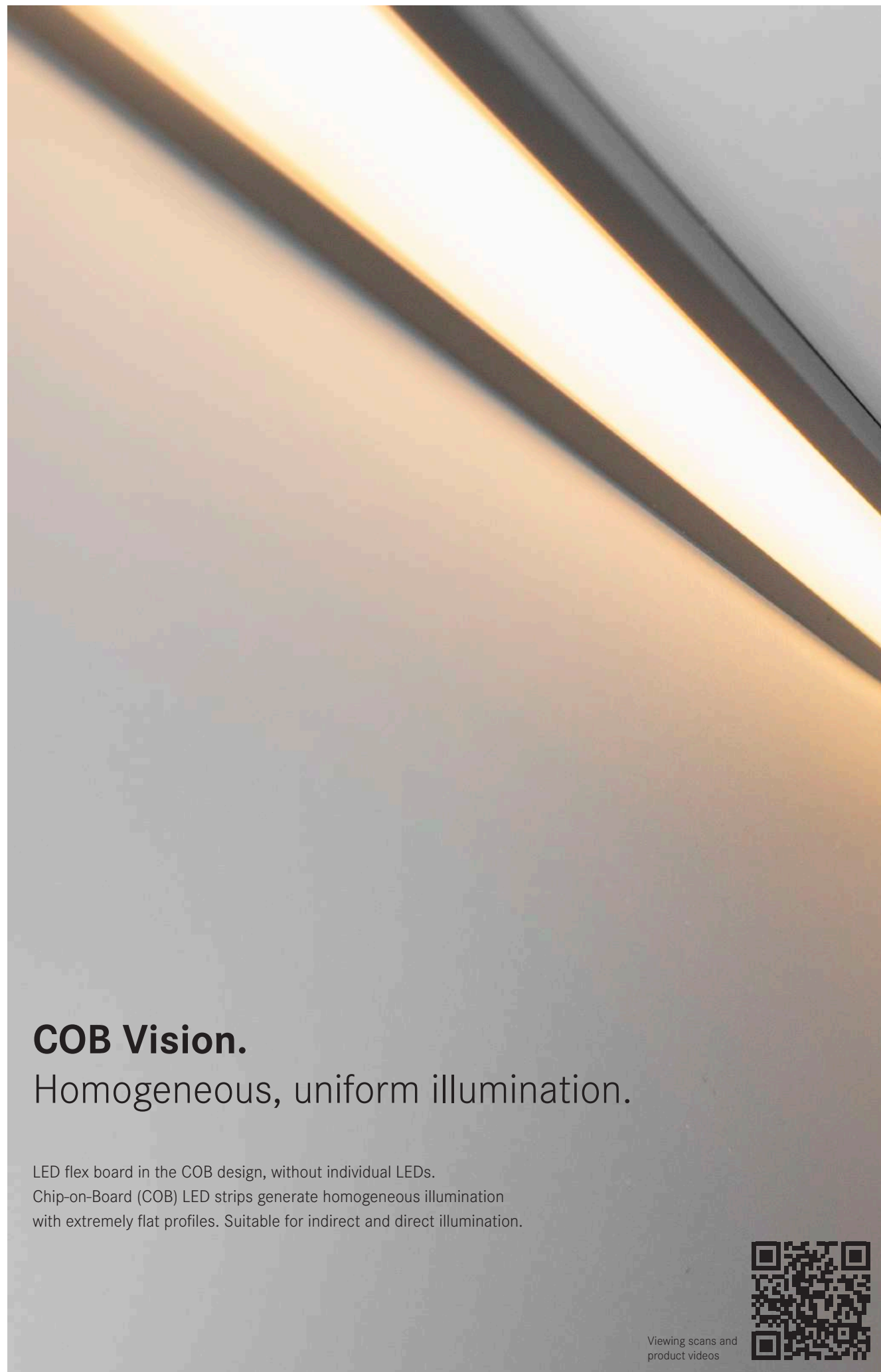

COB Vision. Homogeneous, uniform illumination.

LED flex board in the COB design, without individual LEDs.
Chip-on-Board (COB) LED strips generate homogeneous illumination
with extremely flat profiles. Suitable for indirect and direct illumination.

Viewing scans and
product videos





QualityFlex Special Applications, Thin4, CRI > 90, 7.2 W/m

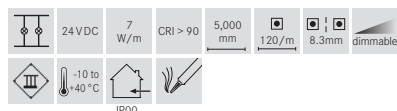
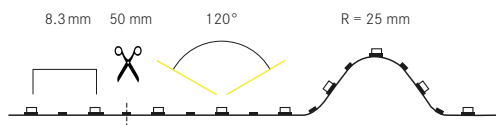

Key features of the products

- Thin, four-millimeter LED flex boards for filigree applications.
- Ideally suited for applications in furniture items or other furnishing objects as well as extremely narrow areas.
- High color rendering with CRI > 90.
- Available color temperatures: 2700 K, 3000 K, 4000 K.
- Suitable for indoor dry applications with IP00.
- Small pitch of 50 millimeters.
- 350 mm feed cable.
- Dimmable using suitable accessories.



Electrical data

LED circuit board:	SMD-LED 2110
Power consumption:	7.2 W/m
Number of LEDs per meter:	120
Rated voltage:	24 VDC
Protection class:	III
Ambient temperature:	-10 to +40 °C

Photometric data

Color rendering index:	CRI > 90
Efficiency:	80 lm/W at IP00, 3000 K

Light technical data

Beam angle:	120°
-------------	------

Service life:

Service life:	L80/B10: 50,000 h L70/B50: > 50,000 h at: 25 °C
---------------	---

Mechanical data

Length of the board:	5,000 mm
Maximum module length:	5,000 mm
Pitch dimension:	50 mm
Smallest bending radius:	25 mm
Short pitch:	8.3 mm
Connection cable:	2 x 350 mm
Self-adhesive:	yes

For heat dissipation, it is absolutely necessary to mount on aluminum profiles.

Variants of LED flex boards

IP00		Uncoated LED flex board for indoor application in dry areas. Do not wipe with a damp cloth.					
Item no.	Price in €	Item no.	Price in €	Color temperature	Luminous flux/m	EELC Spectrum A-G	Dimensions [W x H]
15314027	189.00	75314027	2.70	2700 K	Approximately 560 lm	G	4 x 1.8 mm
15314003	189.00	75314003	2.70	3100 K	Approximately 583 lm	F	4 x 1.8 mm
15314004	189.00	75314004	2.70	4100 K	Approximately 619 lm	F	4 x 1.8 mm
		75998000	11.90	Assembly with protection class IP00			



Profile overview

Surface-mounted profiles



Recessed profiles

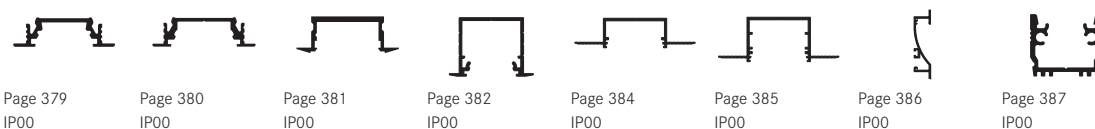

Surface-mounted corner profiles



Special profiles

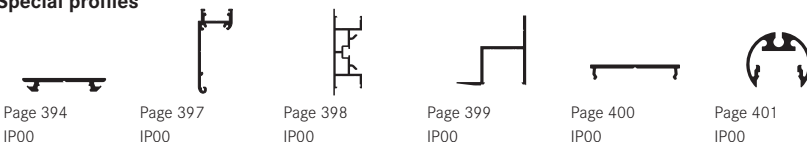

Based on the flex board with protection class IP00 in combination with an opal cover:

■ Homogeneous lighting pattern is possible, ■ LED points are visible, no homogeneous lighting pattern, ■ cannot be combined with the flex board
 * = a homogeneous light line is only possible in combination with a high cover

Power supplies



Switchable

Item no. 17241000
40 W, LED power supply 24 V DC, Switchable
 For operation up to 5,000 mm (page 534)



Dimmable

Item no. 17528000
White light radio controller
 for controlling single-color LED modules in the white light range. Page 543



Dimmable

Item no. 17231000
LED power supply 24 V DC, 75 W, dimmable phase section
 For operation up to 5,000 mm (page 535)

You will find additional power supplies and controllers from page 530 onwards.





Private residence, Berlin

QualityFlex Special Applications, OneCut, CRI > 90, 18 W/m, 12 V DC

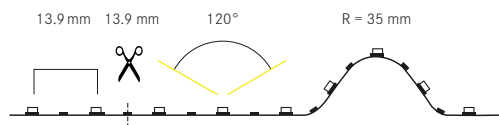

	24 VDC	18 W/m	CRI > 90	5,000 mm	
	-10 to +40 °C				

Key features of the products

- Divisible after each individual LED (every 13.9 cm) for highest flexibility in assembly.
- Customized lighting solutions for individual lighting concepts.
- High color rendering of CRI > 90.
- Optimal for ambient and general lighting of rooms, architectural applications, and areas where high illumination is desired.
- Color temperature: 2700 K, 3000 K, 4000 K.
- 12 DC model.
- Dimmable using suitable accessories.



Electrical data

LED circuit board:	SMD-LED 5050
Power consumption:	18 W/m
Number of LEDs per meter:	72
Rated voltage:	12 VDC
Protection class:	III
Ambient temperature:	-10 to +40 °C

Photometric data

Color rendering index:	CRI > 90
Efficiency:	83 lm/W at IP00, 3000 K

Light technical data

Beam angle:	120°
-------------	------

Service life:

Service life:	L80/B10: 50,000 h L70/B50: > 50,000 h ta: 25 °C
---------------	---

Mechanical data

Length of the board:	5,000 mm
Maximum module length:	5,000 mm
Pitch dimension:	13.9 mm
Smallest bending radius:	35 mm
Short pitch:	13.9 mm
Connection cable:	2 x 350 mm
Self-adhesive:	yes

For heat dissipation, it is absolutely necessary to mount on aluminum profiles.

Variants of LED flex boards

IP00		Uncoated LED flex board for indoor application in dry areas. Do not wipe with a damp cloth.					
Item no.	Price in €	Item no.	Price in €	Color temperature	Luminous flux/m	EELK Spectrum A-G	Dimensions [W x H]
15311027	399.00	75311027	1.60	2700 K	Approximately 1,470lm	F	12 x 2.2 mm
15311003	399.00	75311003	1.60	3000 K	Approximately 1,505lm	F	12 x 2.2 mm
15311004	399.00	75311004	1.60	4000 K	Approximately 1,557lm	F	12 x 2.2 mm
		75998000	11.90	Assembly with protection class IP00			

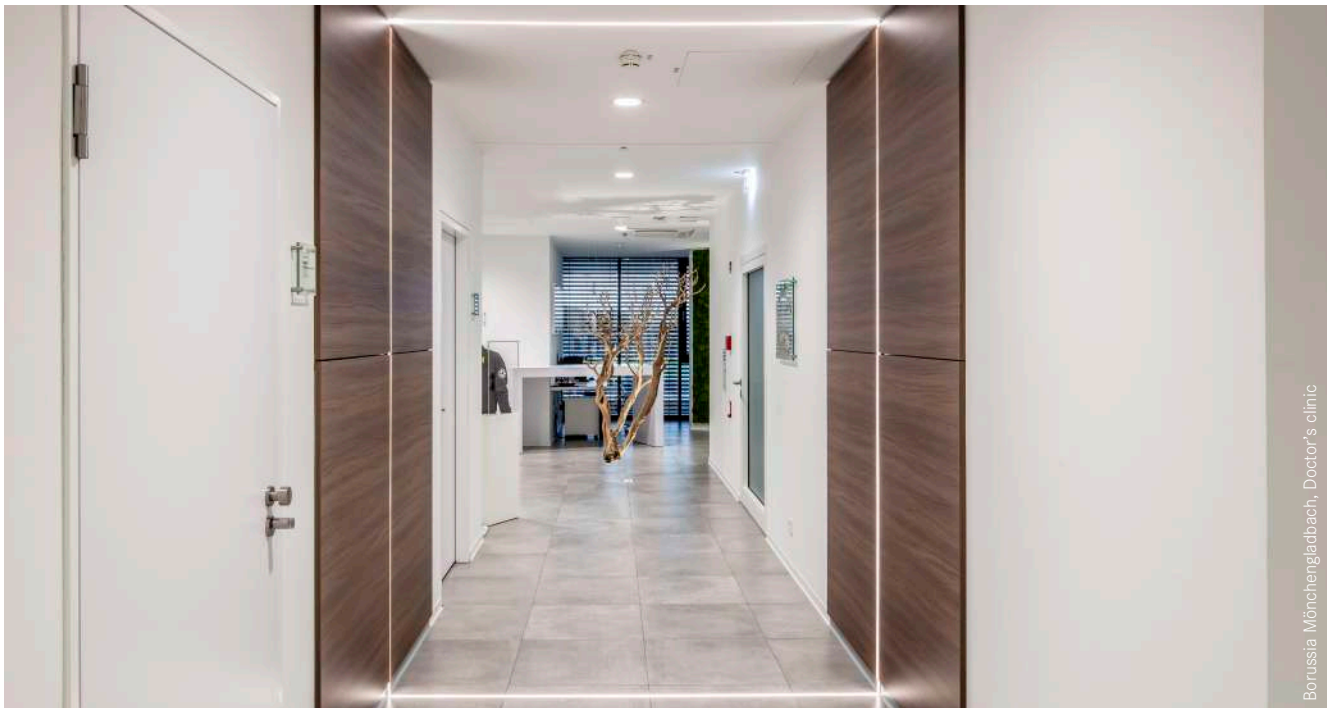

Borussia Mönchengladbach, Doctor's clinic

Profile overview

Surface-mounted profiles



Recessed profiles

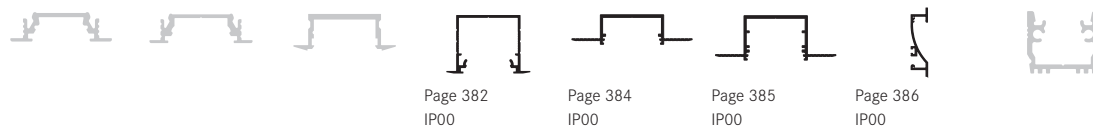

Surface-mounted corner profiles



Special profiles

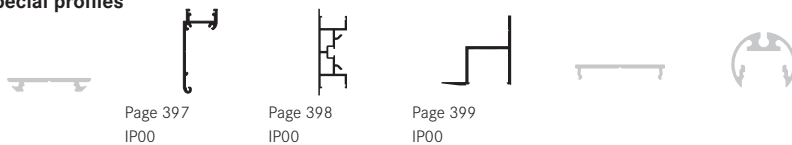

Based on the flex board with protection class IP00 in combination with an opal cover:

- Homogeneous lighting pattern is possible, ■ LED points are visible, no homogeneous lighting pattern, ■ cannot be combined with the flex board
- * = a homogeneous light line is only possible in combination with a high cover

Power supplies



Switchable

Item no. 17122000
LED power supply 12 V DC,
120 W, switchable
For operation from up to 5,000 mm
(page 530)



Dimmable

Item no. 17528000
White light radio controller
for controlling single-color LED
modules in the white light range.
Page 543

You will find additional
power supplies and
controllers from
page 530 onwards.

QualityFlex Special Applications, dim2warm, CRI > 90, 19.2 W/m

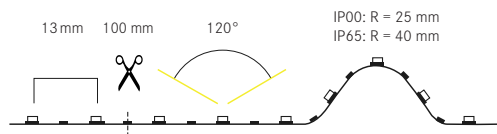

	24 VDC		19.2 W/m		CRI > 90		5,000 mm		120/m		13 mm		dimmable
	IP00		IP65		-10 to +40 °C								

Key features of the products

- With the latest LED technology, ensures a feel-good ambience when the light is dimmed.
- Dimming effects like incandescent lamps and warm white light like candlelight.
- High color rendering with CRI > 90.
- Color temperature: 3000 K - 1800 K.
- Matched to our dim2warm spotlights.
- Control unit: 2-core.
- Dimmable using suitable accessories.*

Electrical data

LED circuit board:	SMD-LED 2835
Power consumption:	19.2 W/m
Number of LEDs per meter:	120
Rated voltage:	24 VDC
Protection class:	III
Ambient temperature:	-10 to +40 °C
Control:	2-core

Photometric data

Color rendering index:	CRI > 90
Color consistency:	SDCM < 3
Efficiency:	59 lm/W at IP00, 3000 K

Light technical data

Beam angle:	120°
-------------	------

Service life:

Service life:	L80/B10: 50,000 h L70/B50: > 50,000 h ta: 25 °C
---------------	---

Mechanical data

Length of the board:	5,000 mm
Maximum module length:	5,000 mm
Pitch dimension:	100 mm
Smallest bending radius:	IP00: 25 mm IP65: 40 mm
Short pitch:	13 mm
Connection cable:	2 x 300 mm
Self-adhesive:	yes

For heat dissipation, it is absolutely necessary to mount on aluminum profiles.

* **Compatible with all Brumberg LED dimmers, except the phase dimmable converters 17230000, 17231000 and 17232000.**

Variants of LED flex boards



IP00		Uncoated LED flex board for indoor application in dry areas. Do not wipe with a damp cloth.					
Item no.	Price €	Item no.	Price in €	Color temperature	Luminous flux/m	EEK Spectrum A-G	Dimensions [W x H]
5,000 mm		100 mm					
15312003	299.00	75312003	8.60	3000 K 1800 K	Maximum 1,150 lm	G	10 x 1.2 mm
			75998000	11.90	Assembly with protection class IP00		

IP65		Transparent, durable silicone coating for optimum protection against mechanical stress and moisture, washable.					
Item no.	Price €	Item no.	Price in €	Color temperature	Luminous flux/m	EEK Spectrum A-G	Dimensions [W x H]
5,000 mm		100 mm					
15362003	329.00	75362003	9.50	3000 K 1800 K	Maximum 1,000 lm	G	12.5 x 5 mm
			75999000	17.90	Assembly with enhanced protection class IP6...		



Private house, Obernburg

Profile overview

Surface-mounted profiles



Recessed profiles

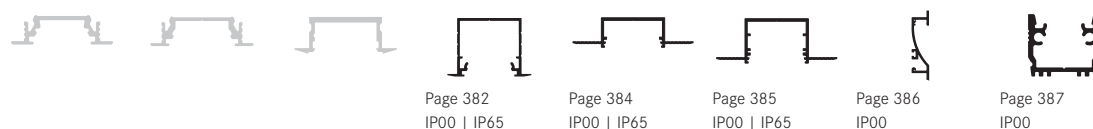

Surface-mounted corner profiles



Special profiles



Based on the flex board with protection class IP00 in combination with an opal cover:

- Homogeneous lighting pattern is possible, ■ LED points are visible, no homogeneous lighting pattern, ■ cannot be combined with the flex board
- * = a homogeneous light line is only possible in combination with a high cover

Power supplies



Switchable

Item no. 17243000
LED power supply 24 V DC,
120 W, switchable
For operation up to 5,000 mm
(page 534)



Dimmable

Item no. 17528000
White light radio controller
For controlling single-color LED
modules in the white light range
Page 543

You will find additional
power supplies and
controllers from
page 530 onwards.

QualityFlex special applications, TunableWhite, 19.2 W/m

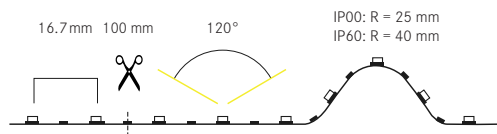

	24 VDC		19.2 W/m		CRI > 90		5,000 mm		120/m		16.7mm		dimmable
	-10 to +40 °C		IP00/ IP60										

NEW

Electrical data

LED circuit board:	SMD-LED 2835
Power consumption:	19.2 W/m
Number of LEDs per meter:	120
Rated voltage:	24 VDC
Protection class:	III
Ambient temperature:	-10 to +40 °C
Control:	Negative (3-core)

Photometric data

Color rendering index:	CRI > 90
Efficiency:	87 lm/W at IP00, 2000 K

Light technical data

Beam angle:	120°
-------------	------

Service life:

Service life:	L80/B10: 50,000 h L70/B50: > 50,000 h ta: 25 °C
---------------	---

Mechanical data

Length of the board:	5,000 mm
Maximum module length:	5,000 mm
Pitch dimension:	100 mm
Smallest bending radius:	IP00: 25 mm IP60: 40 mm
Short pitch:	16.7 mm
Connection cable:	2 x 350 mm
Self-adhesive:	yes

For heat dissipation, it is absolutely necessary to mount on aluminum profiles.

Key features of the products

- Compatible with our TunableWhite LED insert 12843004.
- The color temperature and brightness can be changed using the 2-channel dimming.
- Optimum control capability via DALI (DT8) or TunableWhite radio remote control.
- Protection class: IP00 or IP60.
- Color temperature: 2000 K to 6500 K.
- Beam angle: 120°.
- High color rendering with CRI > 90.

Variants of LED flex boards



IP00		Uncoated LED flex board for indoor application in dry areas. Do not wipe with a damp cloth.					
Item no.	Price in €	Item no.	Price in €	Color temperature	Luminous flux/m	EELK Spectrum A-G	Dimensions [W x H]
15216004	269.00	75216004	7.70	2000 K	Approximately 760 lm	F	10 x 2.1 mm
				6500 K	Approximately 910 lm		
		75998000	11.90	Assembly with protection class IP00			

IP60		Resistant silicone coating, insensitive to mechanical stress, wipeable.					
Item no.	Price in €	Item no.	Price in €	Color temperature	Luminous flux/m	EELK Spectrum A-G	Dimensions [W x H]
15226004	299.00	75226004	8.70	2000 K	Approximately 727 lm	F	10 x 4 mm
				6500 K	Approximately 870 lm		
		75999000	17.90	Assembly with enhanced protection class IP6...			

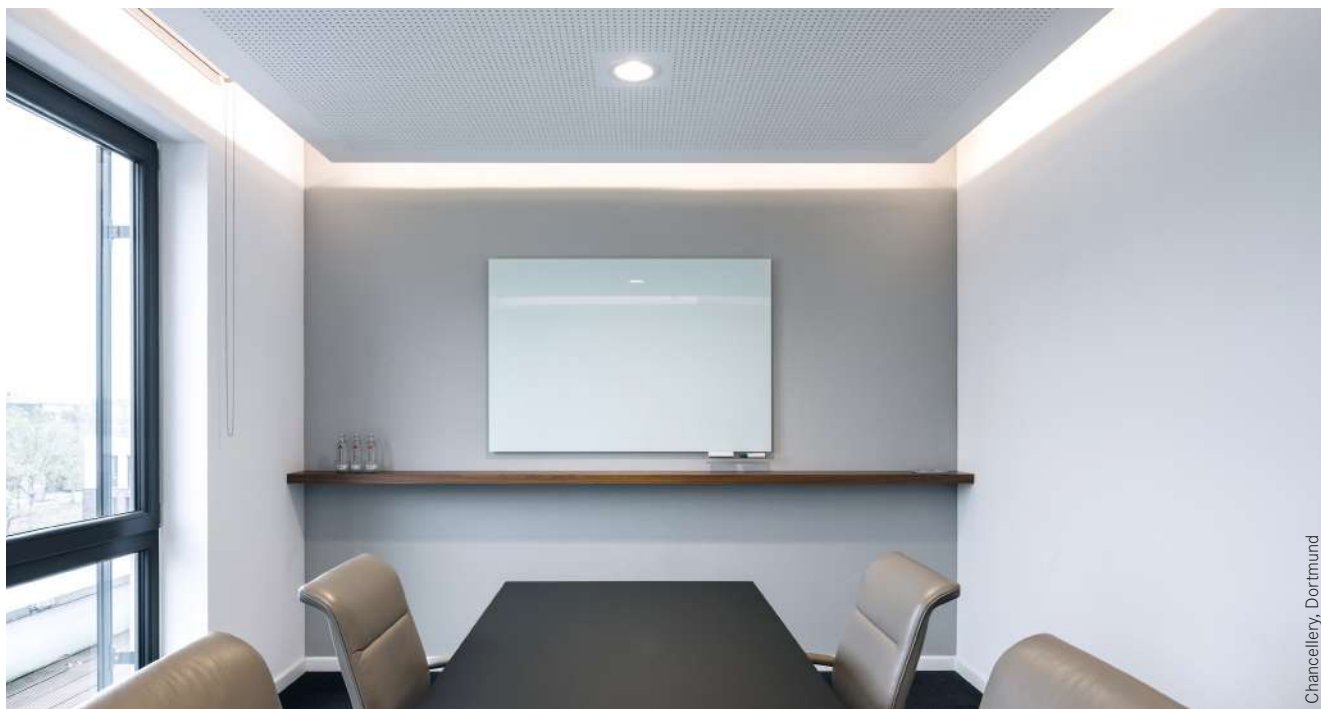

Chancellery, Dortmund

Profile overview

Surface-mounted profiles



Recessed profiles

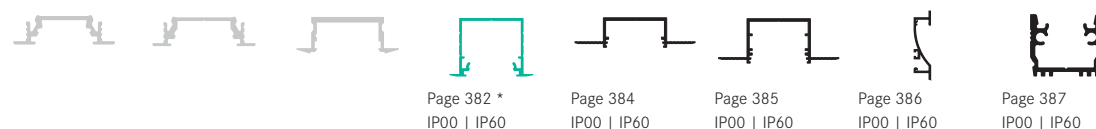

Surface-mounted corner profiles



Special profiles

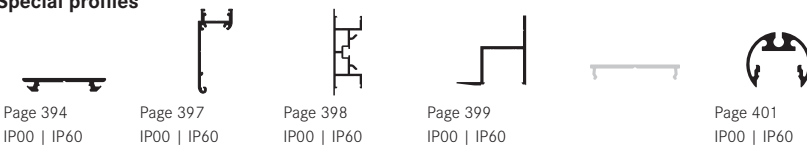

Based on the flex board with protection class IP00 in combination with an opal cover:

■ Homogeneous lighting pattern is possible, ■ LED points are visible, no homogeneous lighting pattern, ■ cannot be combined with the flex board
* = a homogeneous light line is only possible in combination with a high cover

Power supplies



Switchable

Item no. 17243000
LED power supply 24 V DC, 120 W, switchable
For operation from up to 5,000 mm.
(Page 534)



Dimmable

Item no. 17518000
TunableWhite wireless technology control
For two-color LED modules in the white light range
Page 544



Dimmable

Item no. 18155000
LED dimmer 12-24 V DC, DALI (DT8), dimmable
For operation up to 5,000 mm
(page 536)

You will find additional power supplies and controllers from page 530 onwards.

QualityFlex special applications, TunableWhite, 19.2 W/m

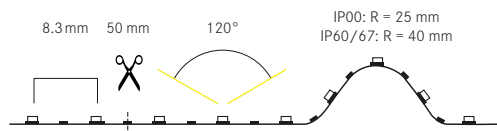

	24 VDC	19.2 W/m	CRI > 80	5,000 mm	120/m	8.3mm	dimming
	-10 to +40 °C	IP00/ IP60	IP67				

Key features of the products

- The color temperature and brightness can be changed using the 2-channel dimming.
- Optimum control capability via DALI (DT8) or TunableWhite radio remote control.
- Protection class: IP00, IP60, IP67.
- Color temperature: 2700 K to 5700 K with IP00.
- Beam angle: 120°.

Electrical data

LED circuit board:	SMD-LED 3527 Dual layout
Power consumption:	19.2 W/m
Number of LEDs per meter:	120
Rated voltage:	24 VDC
Protection class:	III
Ambient temperature:	-10 to +40 °C
Control:	Negative (3-core)

Photometric data

Color rendering index:	CRI > 80
Efficiency:	85 lm/W at IP00, 2700 K

Light technical data

Beam angle:	120°
-------------	------

Service life:

Service life:	L80/B10: 50,000 h L70/B50: > 50,000 h ta: 25 °C
---------------	---

Mechanical data

Length of the board:	5,000 mm
Maximum module length:	5,000 mm
Pitch dimension:	50 mm
Smallest bending radius:	IP00: 25 mm IP60/67: 40 mm
Short pitch:	8.3 mm
Connection cable:	2 x 350 mm
Self-adhesive:	yes

For heat dissipation, it is absolutely necessary to mount on aluminum profiles.

Variants of LED flex boards



IP00 Uncoated LED flex board for indoor application in dry areas. Do not wipe with a damp cloth.

Item no.	Price in €	Item no.	Price in €	Color temperature	Luminous flux/m	EELK Spectrum A-G	Dimensions [W x H]
15215004	379.00	75215004	5.30	2700 K	Approximately 758 lm	G	10 x 2.1 mm
				5700 K	Approximately 873 lm		
		75998000	11.90	Assembly with protection class IP00			

IP60 Resistant silicone coating, insensitive to mechanical stress, wipeable.

Item no.	Price in €	Item no.	Price in €	Color temperature	Luminous flux/m	EELK Spectrum A-G	Dimensions [W x H]
15225004	409.00	75225004	6.20	3000 K	Approximately 700 lm	G	10 x 3.2 mm
				6000 K	Approximately 800 lm		
		75999000	17.90	Assembly with protection class IP6.			

IP67 White, light-reflecting support profile with durable silicone coating. Optimum protection against mechanical shock and moisture, washable.

Item no.	Price in €	Item no.	Price in €	Color temperature	Luminous flux/m	EELK Spectrum A-G	Dimensions [W x H]
15275004	439.00	75275004	6.50	3000 K	Approximately 643 lm	G	12 x 4.8 mm
				6000 K	Approximately 700 lm		
		75999000	17.90	Assembly with protection class IP6.			



Hotel Seegarten, Sorpesee

Profile overview

Surface-mounted profiles



Recessed profiles

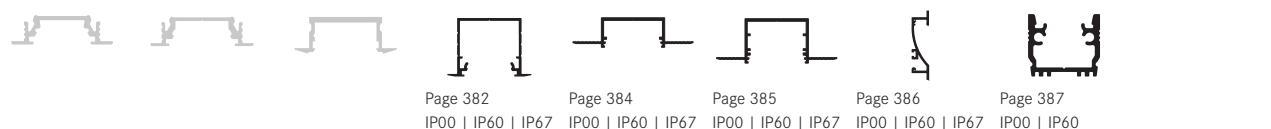

Surface-mounted corner profiles



Special profiles



Based on the flex board with protection class IP00 in combination with an opal cover:

- Homogeneous lighting pattern is possible, ■ LED points are visible, no homogeneous lighting pattern, ■ cannot be combined with the flex board
- * = a homogeneous light line is only possible in combination with a high cover

Power supplies



Switchable

Item no. 17243000
LED power supply 24 V DC, 120 W, switchable
For operation up to 5,000 mm (page 534)



Dimmable

Item no. 17518000
TunableWhite wireless technology control
For two-color LED modules in the white light range (page 544)



Dimmable

Item no. 18155000
LED dimmer 12-24 V DC, DALI (DT8), dimmable
For operation up to 5,000 mm (page 536)

You will find additional power supplies and controllers from page 530 onwards.

QualityFlex Special Applications, Food, 14.4 W/m

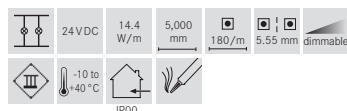
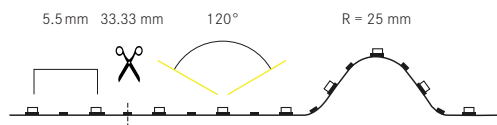

Key features of the products

- LED flex boards for the presentation of food.
- Coordinated color rendering for optimum product presentation of: Red meat, bread & bakery, cheese & restaurant, fruit, marbled meat, vegetables.
- Divisible every 33.33 mm.



Electrical data

LED circuit board:	SMD-LED 3528
Power consumption:	14.4 W/m
Number of LEDs per meter:	180
Rated voltage:	24 VDC
Protection class:	III
Ambient temperature:	-10 to +40 °C

Light technical data

Beam angle:	120°
-------------	------

Service life:

Service life:	L80/B10: 50,000 h L70/B50: > 50,000 h ta: 25 °C
---------------	---

Mechanical data

Dimensions [W x H]:	10 mm x 2.35 mm
Length of the board:	5,000 mm
Maximum module length:	5,000 mm
Pitch dimension:	33.33 mm
Smallest bending radius:	25 mm
Short pitch:	5.5 mm
Connection cable:	2 x 350 mm
Self-adhesive:	yes

For heat dissipation, it is absolutely necessary to mount on aluminum profiles.

Variants of LED flex boards

IP00		Uncoated LED flex board for indoor application in dry areas. Do not wipe with a damp cloth.						
Item no.	Price in €	Item no.	Price €	Color temperature	Luminous flux per meter	EEK Spectrum A-G	CRI	Application
88203020	275.00	75203020	2.70	2050 K	Approximately 1,220 lm	F	42	Meat red
88203024	275.00	75203024	2.70	2400 K	Approximately 1,040 lm	G	92	Bread, Bakery products
88203028	275.00	75203028	2.70	2750 K	Approximately 1,200 lm	F	92	Cheese, Restaurant
88203030	275.00	75203030	2.70	3050 K	Approximately 1,240 lm	F	92	Fruits
88203038	275.00	75203038	2.70	3850 K	Approximately 1,350 lm	F	75	Meat (marbled)
88203040	275.00	75203040	2.70	4050 K	Approximately 1,350 lm	F	90	Vegetables
		75998000	11.90	Assembly with protection class IP00				



Profile overview

Surface-mounted profiles



Recessed profiles

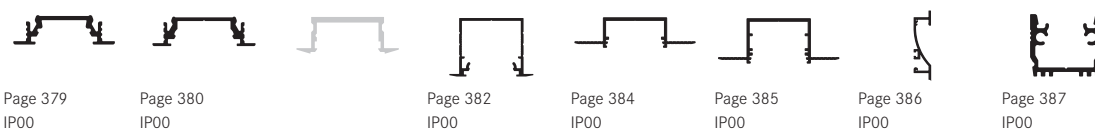

Surface-mounted corner profiles



Special profiles

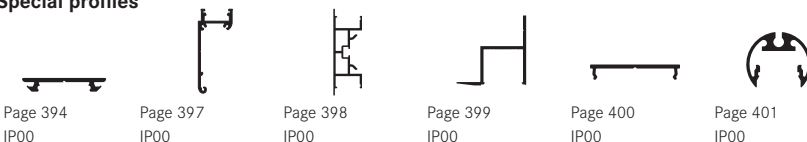

Based on the flex board with protection class IP00 in combination with an opal cover:

■ Homogeneous lighting pattern is possible, ■ LED points are visible, no homogeneous lighting pattern, ■ cannot be combined with the flex board
 * = a homogeneous light line is only possible in combination with a high cover

Power supplies



Switchable

Item no. 17243000
LED power supply 24 V DC,
120 W, switchable
 For operation up to 5,000 mm
 (page 534)

**You will find additional
 power supplies and
 controllers from
 page 530 onwards.**

QualityFlex Special Applications, RGB, 14.4 W/m

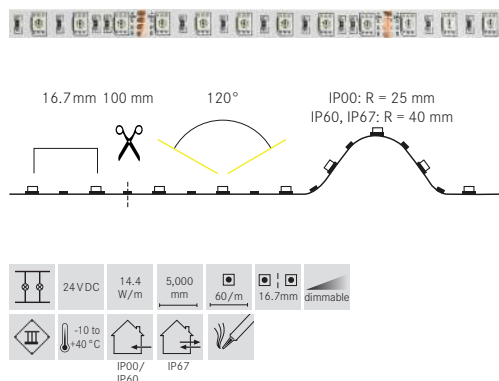

Key features of the products

- Dynamic color accents in red, green and blue.
- Suitable for indoor (IP00, IP60) and outdoor (IP67) applications
- Optimal for colorful accentuation in residential areas or applications in hotels and restaurants using mixed colors.
- Decorative illumination and accent lighting of light covers, linear applications and backlighting.
- Compatible with our Brumberg 3-channel 24 V DC controllers, RGB.

Electrical data

LED circuit board:	SMD-LED 5050
Power consumption:	14.4 W/m
Number of LEDs per meter:	60
Rated voltage:	24 VDC
Protection class:	III
Ambient temperature:	-10 to +40 °C
Control:	Negative (4-core)

Light technical data

Beam angle:	120°
-------------	------

Service life:

Service life:	L80/B10: 50,000 h L70/B50: > 50,000 h ta: 25 °C
---------------	---

Mechanical data

Length of the board:	5,000 mm
Maximum module length:	5,000 mm
Pitch dimension:	100 mm
Smallest bending radius:	IP00: 25 mm IP60/ IP67: 40 mm
Short pitch:	16.7 mm
Connection cable:	2 x 350 mm
Self-adhesive:	yes

For heat dissipation, it is absolutely necessary to mount on aluminum profiles.

* Special product: Caution! The product with the red, green or blue Color temperature is a special product. This product with these Color temperatures is used for colorful illumination. The spectral distribution of the light is used to change the appearance of illuminated scenes or illuminated objects in addition to making them visible. The product is not intended for use in other applications. The special product is not suitable for room lighting in households.

Variants of LED flex boards



IP00		Uncoated LED flex board for indoor application in dry areas. Do not wipe with a damp cloth.					
Item no.	Price in €	Item no.	Price in €	Color temperature	Luminous flux/m	EELK Spectrum A-G	Dimensions [W x H]
15203001	198.00	75203001	5.50	Red	Approximately 158 lm	G	10 x 2.2 mm
				Green	Approximately 408 lm		
				Blue	Approximately 82 lm		
		75998000	11.90	Assembly with protection class IP00			

IP60		Resistant silicone coating, insensitive to mechanical stress, wipeable.					
Item no.	Price in €	Item no.	Price in €	Color temperature	Luminous flux/m	EELK Spectrum A-G	Dimensions [W x H]
15223001	249.00	75223001	7.00	Red	Approximately 134 lm	G	10 x 3.2 mm
				Green	Approximately 346 lm		
				Blue	Approximately 67 lm		
		75998000	11.90	Assembly with protection class IP6.			

IP67		White, light-reflecting support profile with durable silicone coating. Optimum protection against mechanical shock and moisture, washable.					
Item no.	Price in €	Item no.	Price in €	Color temperature	Luminous flux/m	EELK Spectrum A-G	Dimensions [W x H]
15273001	279.00	75273001	7.90	Red	Approximately 134 lm	G	12 x 5 mm
				Green	Approximately 346 lm		
				Blue	Approximately 67 lm		
		75999000	17.90	Assembly with protection class IP6.			



Rex Cinema, Pforzheim

Profile overview

Surface-mounted profiles



Recessed profiles

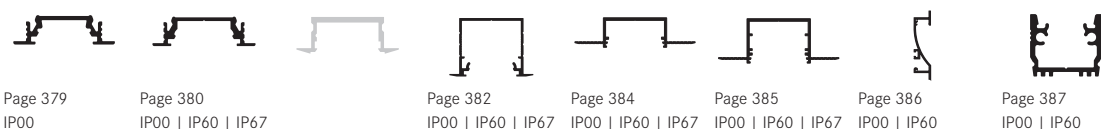

Surface-mounted corner profiles

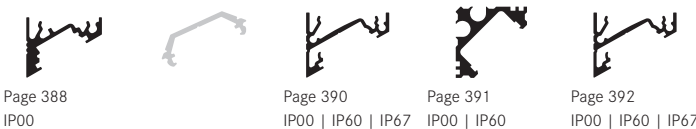

Special profiles

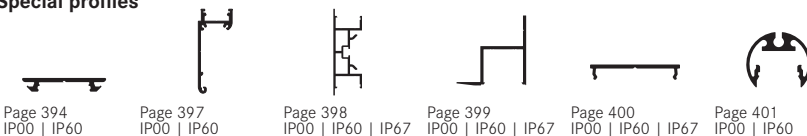

Based on the flex board with protection class IP00 in combination with an opal cover:

- Homogeneous lighting pattern is possible, ■ LED points are visible, no homogeneous lighting pattern, ■ cannot be combined with the flex board
- * = a homogeneous light line is only possible in combination with a high cover

Power supplies



Switchable

Item no. 17243000
LED power supply 24 V DC,
120 W, switchable
For operation up to 5,000 mm
(page 534)



Dimmable

Item no. 18233000
RGB wireless technology control
For controlling RGB LED modules in
the color light range.
Page 545

You will find additional
power supplies and
controllers from
page 530 onwards.

QualityFlex Special Applications, RGB, 14.4 W/m

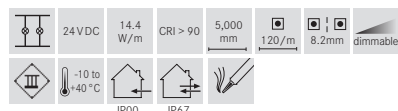
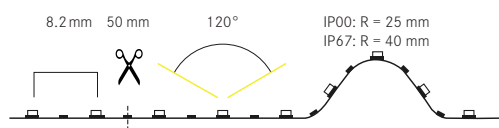

NEW

Electrical data

LED circuit board:	SMD-LED 3838
Power consumption:	14.4 W/m
Number of LEDs per meter:	120
Rated voltage:	24 VDC
Protection class:	III
Ambient temperature:	-10 to +40 °C
Control:	Negative (4-core)

Light technical data

Beam angle: 120°

Service life:

Service life:	L80/B10: 50,000 h
	L70/B50: > 50,000 h
	at: 25 °C

Mechanical data

Length of the board:	5,000 mm
Maximum module length:	5,000 mm
Pitch dimension:	50 mm
Smallest bending radius:	IP00: 25 mm
	IP67: 40 mm
Short pitch:	8.2 mm
Connection cable:	2 x 350 mm
Self-adhesive:	yes

For heat dissipation, it is absolutely necessary to mount on aluminum profiles.

* Special product: Caution! The product with the red, green or blue Color temperature is a special product. This product with these Color temperatures is used for colorful illumination. The spectral distribution of the light is used to change the appearance of illuminated scenes or illuminated objects in addition to making them visible. The product is not intended for use in other applications. The special product is not suitable for room lighting in households.

Key features of the products

- Dynamic color accents in red, green and blue.
- SMD-LED 3838 chip for harmonic lighting effects.
- Suitable for indoor (IP00) and outdoor (IP67) applications.
- Optimal for colorful accentuation in residential areas or applications in hotels and restaurants.
- Decorative illumination and accent lighting of light covers, linear applications and backlighting.
- **Ideal for gaming or entertainment use.**
- Compatible with our 3-channel, 24 V DC controllers, RGB.

Variants of LED flex boards



IP00		Uncoated LED flex board for indoor application in dry areas. Do not wipe with a damp cloth.					
Item no.	Price in €	Item no.	Price in €	Color temperature	Luminous flux/m	EEK Spectrum A-G	Dimensions [W x H]
15209001	278.00	75209001	3.90	Red	Approximately 120 lm	G	8 x 2 mm
				Green	Approximately 475 lm		
				Blue	Approximately 98 lm		
			75998000	11.90	Assembly with protection class IP00		

IP67		White, light-reflecting support profile with durable silicone coating. Optimum protection against mechanical shock and moisture, washable.					
Item no.	Price in €	Item no.	Price in €	Color temperature	Luminous flux/m	EEK Spectrum A-G	Dimensions [W x H]
15279001	299.00	75279001	4.30	Red	Approximately 99 lm	G	11 x 5 mm
				Green	Approximately 390 lm		
				Blue	Approximately 81 lm		
			75998000	11.90	Assembly with protection class IP6.		



Profile overview

Surface-mounted profiles



Recessed profiles

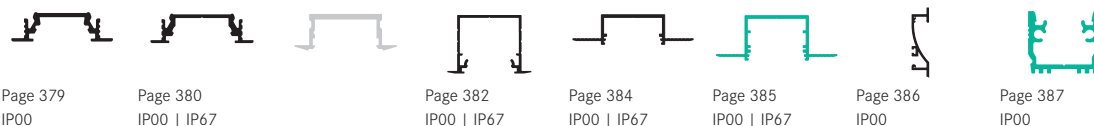

Surface-mounted corner profiles



Special profiles



Based on the flex board with protection class IP00 in combination with an opal cover:

■ Homogeneous lighting pattern is possible, ■ LED points are visible, no homogeneous lighting pattern, ■ cannot be combined with the flex board
 * = a homogeneous light line is only possible in combination with a high cover

Power supplies



Switchable

Item no. 17243000
LED power supply 24 V DC, 120 W, switchable
 For operation up to 5,000 mm (page 534)



Dimmable

Item no. 18233000
RGB wireless technology control
 For controlling RGB LED modules in the color light range. (Page 545)

You will find additional power supplies and controllers from page 530 onwards.

QualityFlex Special Applications, RGBW, 17 W/m

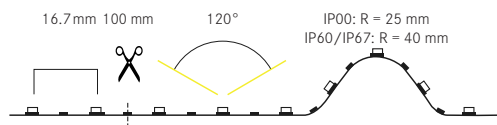

	24 VDC		17 W/m		CRI > 90		5,000 mm		120/m		16.7mm		dimming
	-10 to +40 °C		IP00/ IP60		IP67								

Key features of the products

- Color play and general lighting in an LED flex board.
- Efficient changeable illumination of light covers, linear applications, light ceilings as well as backlighting.
- Color temperatures: red / green / blue / white (4000 K)
- Countless mixed colors can be implemented.
- Suitable for indoor (IP00, IP60) and outdoor (IP67) applications.
- Divisible every 100 mm.
- Compatible with our 4-channel, 24 V DC controllers, RGBW.

Electrical data

LED circuit board:	SMD-LED 3527 Dual layout
Power consumption:	17 W/m
Number of LEDs per meter:	120
Rated voltage:	24 VDC
Protection class:	III
Ambient temperature:	-10 to +40 °C
Control:	Negative (5-core)

Photometric data

Color rendering index:	CRI > 80*
Efficiency:	89 lm/W at IP00, 4000 K

* Applicable only for white light LED flex boards.

Light technical data

Beam angle:	120°
-------------	------

Service life:

Service life:	L80/B10: 50,000 h L70/B50: > 50,000 h ta: 25 °C
---------------	---

Mechanical data

Length of the board:	5,000 mm
Maximum module length:	5,000 mm
Pitch dimension:	100 mm
Smallest bending radius:	IP00: 25 mm IP60/IP67: 40 mm
Short pitch:	16.7 mm
Connection cable:	2 x 350 mm
Self-adhesive:	yes

For heat dissipation, it is absolutely necessary to mount on aluminum profiles.

* Special product: Caution! The product with the red, green or blue Color temperature is a special product. This product with these Color temperatures is used for colorful illumination. The spectral distribution of the light is used to change the appearance of illuminated scenes or illuminated objects in addition to making them visible. The product is not intended for use in other applications. The special product is not suitable for room lighting in households.

Variants of LED flex boards



IP00		Uncoated LED flex board for indoor application in dry areas. Do not wipe with a damp cloth.					
Item no.	Price in €	Item no.	Price in €	Color temperature	Luminous flux/m	EELK Spectrum A-G	Dimensions [W x H]
18503002	427.60	75503002	12.00	4000 K	Approximately 417lm	F	10 x 2.1 mm
				Red	Approximately 140 lm		
				Green	Approximately 306 lm		
				Blue	Approximately 55 lm		
		75998000	11.90	Assembly with protection class IP00			

IP60		Resistant silicone coating, insensitive to mechanical stress, wipeable.					
Item no.	Price in €	Item no.	Price in €	Color temperature	Luminous flux/m	EELK Spectrum A-G	Dimensions [W x H]
18523002	492.00	75523002	13.90	5500 K	Approximately 378 lm	F	10 x 3.2 mm
				Red	Approximately 110 lm		
				Green	Approximately 250 lm		
				Blue	Approximately 42 lm		
		75999000	17.90	Assembly with enhanced protection class IP6...			

IP67		White, light-reflecting support profile with durable silicone coating. Optimum protection against mechanical shock and moisture, washable.					
Item no.	Price in €	Item no.	Price in €	Color temperature	Luminous flux/m	EELK Spectrum A-G	Dimensions [W x H]
18573002	512.00	75573002	14.30	5500 K	Approximately 378 lm	F	12 x 5 mm
				Red	Approximately 110 lm		
				Green	Approximately 250 lm		
				Blue	Approximately 42 lm		
		75999000	17.90	Assembly with enhanced protection class IP6...			



Private house, Kirchard

Profile overview

Surface-mounted profiles



Recessed profiles

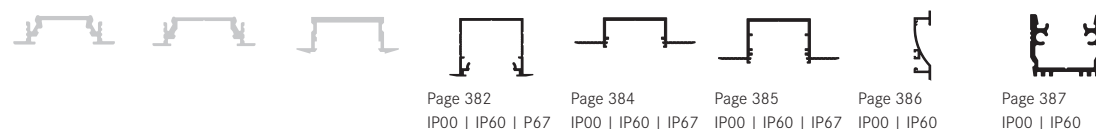

Surface-mounted corner profiles



Special profiles

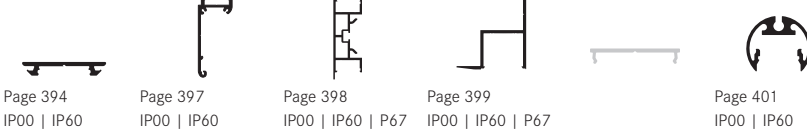

Based on the flex board with protection class IP00 in combination with an opal cover:

■ Homogeneous lighting pattern is possible, ■ LED points are visible, no homogeneous lighting pattern, ■ cannot be combined with the flex board
 * = a homogeneous light line is only possible in combination with a high cover

Power supplies



Switchable

Item no. 17243000
LED power supply 24 V DC,
120 W, switchable
 For operation up to 5,000 mm
 (page 534)



Dimmable

Item no. 18223000
RGBW wireless
technology control
 For controlling the RGBW LED mod-
 ules in colored and white light.
 Page 546

You will find additional
power supplies and
controllers from
page 530 onwards.

QualityFlex Special Applications, Single LED RGBW, 17 W/m

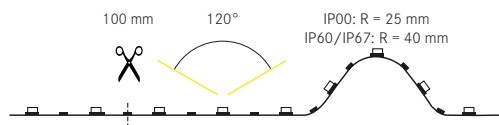

	24 VDC		17 W/m		CRI > 90		5,000 mm		240/m		16.9mm		dimming
	-10 to +40 °C		IP00/ IP60		IP67								

NEW

Electrical data

LED circuit board:	Single LED 2110
Power consumption:	17 W/m
Number of LEDs per meter:	240
Rated voltage:	24 VDC
Protection class:	III
Ambient temperature:	-10 to +40 °C
Control:	Negative (5-core)

Photometric data

Color rendering index:	CRI > 90*
Efficiency:	67 lm/W at IP00, 3000 K

* Applicable only for white light LED flex boards.

Light technical data

Beam angle:	120°
-------------	------

Service life:

Service life:	L80/B10: 50,000 h L70/B50: > 50,000 h ta: 25 °C
---------------	---

Mechanical data

Length of the board:	5,000 mm
Maximum module length:	5,000 mm
Pitch dimension:	100 mm
Smallest bending radius:	IP00: 25 mm IP60/IP67: 40 mm
Short pitch:	16.9 mm
Connection cable:	2 x 350 mm
Self-adhesive:	yes

For heat dissipation, it is absolutely necessary to mount on aluminum profiles.

* Special product: Caution! The product with the red, green or blue Color temperature is a special product. This product with these Color temperatures is used for colorful illumination. The spectral distribution of the light is used to change the appearance of illuminated scenes or illuminated objects in addition to making them visible. The product is not intended for use in other applications. The special product is not suitable for room lighting in households.

Key features of the products

- Effective color play and white light in an LED flex board.
- Single LED 2110 RGBW model.
- Varied illumination of light coves, linear applications, and light ceilings.
- Color temperatures: red / green / blue / white.
- Countless mixed colors can be implemented.
- Suitable for indoor (IP00, IP60) and outdoor (IP67) applications.
- Compatible with our 4-channel, 24 V DC controllers, RGBW.



Variants of LED flex boards

IP00		Uncoated LED flex board for indoor application in dry areas. Do not wipe with a damp cloth.					
Item no.	Price in €	Item no.	Price in €	Color temperature	Luminous flux/m	EEK Spectrum A-G	Dimensions [W x H]
18504002	275.00	75504002	7.60	3000 K	Approximately 340 lm	F	10 x 2 mm
				Red	Approximately 114 lm		
				Green	Approximately 319 lm		
				Blue	Approximately 72 lm		
		75998000	11.90	Assembly with protection class IP00			

IP60		Resistant silicone coating, insensitive to mechanical stress, wipeable.					
Item no.	Price in €	Item no.	Price in €	Color temperature	Luminous flux/m	EEK Spectrum A-G	Dimensions [W x H]
18524002	295.00	75524002	8.20	3000 K	Approximately 287 lm	G	10 x 3 mm
				Red	Approximately 102 lm		
				Green	Approximately 287 lm		
				Blue	Approximately 64 lm		
		75999000	17.90	Assembly with enhanced protection class IP6...			

IP67		Dustproof and jet water protected LED flex boards with durable silicone coating.					
Item no.	Price in €	Item no.	Price in €	Color temperature	Luminous flux/m	EEK Spectrum A-G	Dimensions [W x H]
18574002	315.00	75574002	8.70	3000 K	Approximately 287 lm	G	12.5 x 4.8 mm
				Red	Approximately 102 lm		
				Green	Approximately 287 lm		
				Blue	Approximately 64 lm		
		75999000	17.90	Assembly with enhanced protection class IP6...			



Private house, Bottrop

Profile overview

Surface-mounted profiles



Recessed profiles

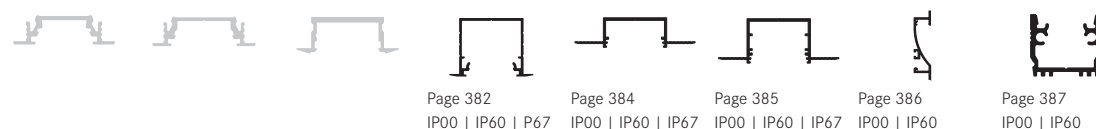

Surface-mounted corner profiles

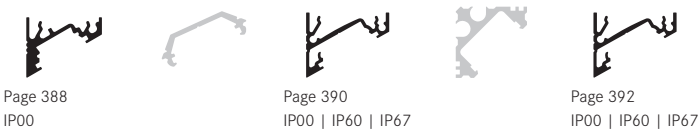

Special profiles

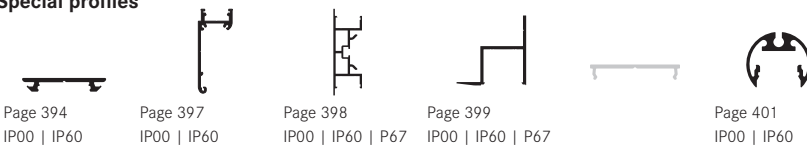

Based on the flex board with protection class IP00 in combination with an opal cover:

- Homogeneous lighting pattern is possible, ■ LED points are visible, no homogeneous lighting pattern, ■ cannot be combined with the flex board
- * = a homogeneous light line is only possible in combination with a high cover

Power supplies



Switchable

Item no. 17243000
LED power supply 24 V DC,
120 W, switchable
For operation up to 5,000 mm
(page 534)



Dimmable

Item no. 18223000
RGBW wireless
technology control
For controlling the RGBW LED
modules in colored and white light.
Page 546

You will find additional
power supplies and
controllers from
page 530 onwards.

QualityFlex Special Applications, Single LED RGB+TW, 24 W/m

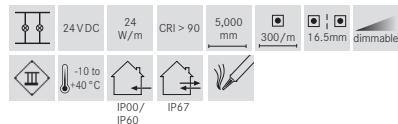
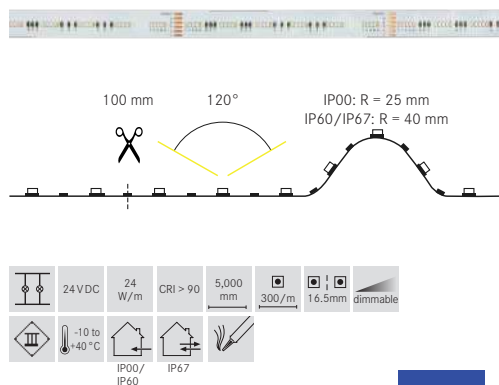

NEW

Electrical data

LED circuit board:	Single LED 2110
Power consumption:	24 W/m
Number of LEDs per meter:	300
Rated voltage:	24 VDC
Protection class:	III
Ambient temperature:	-10 to +40 °C
Control:	Negative (6-core)

Photometric data

Color rendering index: CRI > 90*
 * Applicable only for white light LED flex boards.

Light technical data

Beam angle: 120°

Service life:

Service life: L80/B10: 50,000 h
 L70/B50: > 50,000 h
 ta: 25 °C

Mechanical data

Length of the board:	5,000 mm
Maximum module length:	5,000 mm
Pitch dimension:	100 mm
Smallest bending radius:	IP00: 25 mm IP60/IP67: 40 mm
Short pitch:	16.5 mm
Connection cable:	2 x 350 mm
Self-adhesive:	yes

For heat dissipation, it is absolutely necessary to mount on aluminum profiles.

* Special product: Caution! The product with the red, green or blue Color temperature is a special product. This product with these Color temperatures is used for colorful illumination. The spectral distribution of the light is used to change the appearance of illuminated scenes or illuminated objects in addition to making them visible. The product is not intended for use in other applications. The special product is not suitable for room lighting in households.

Key features of the products

- Dynamic colored light for accent lighting and dynamic white light for illumination applications in an LED flex board.
- Unique LED chip design for clear light effects.
- Color temperatures: red / green / blue / cold white (5700 K) / warm white (2700 K).
- Suitable for indoor (IP00, IP60) and outdoor (IP67) applications.
- Divisible every 100 mm.
- Compatible with our 5-channel, 24 V DC controller, RGB+TW.



Variants of LED flex boards

IP00		Uncoated LED flex board for indoor application in dry areas. Do not wipe with a damp cloth.					
Item no.	Price in €	Item no.	Price in €	Color temperature	Luminous flux/m	EEK Spectrum A-G	Dimensions [W x H]
5,000 mm		100 mm					
18506002	299.00	75506002	8.30	2700 K	Approximately 400 lm	F	12 x 2 mm
				5700 K	Approximately 408 lm		
				Red	Approximately 130 lm		
				Green	Approximately 360 lm		
				Blue	Approximately 82 lm		
		75998000	11.90	Assembly with protection class IP00			

IP60		Resistant silicone coating, insensitive to mechanical stress, wipeable.					
Item no.	Price in €	Item no.	Price in €	Color temperature	Luminous flux/m	EEK Spectrum A-G	Dimensions [W x H]
5,000 mm		100 mm					
18526002	329.00	75526002	9.20	2700 K	Approximately 302 lm	G	12 x 3 mm
				5700 K	Approximately 367 lm		
				Red	Approximately 115 lm		
				Green	Approximately 322 lm		
				Blue	Approximately 72 lm		
		75999000	17.90	Assembly with enhanced protection class IP6...			

IP67		Dustproof and jet water protected LED flex boards with durable silicone coating.					
Item no.	Price in €	Item no.	Price in €	Color temperature	Luminous flux/m	EEK Spectrum A-G	Dimensions [W x H]
5,000 mm		100 mm					
18576002	359.00	75576002	9.90	2700 K	Approximately 302 lm	G	14.5 x 4.8 mm
				5700 K	Approximately 367 lm		
				Red	Approximately 115 lm		
				Green	Approximately 322 lm		
				Blue	Approximately 72 lm		
		75999000	17.90	Assembly with enhanced protection class IP6...			



Private house, Augsburg

Profile overview

Surface-mounted profiles



Recessed profiles

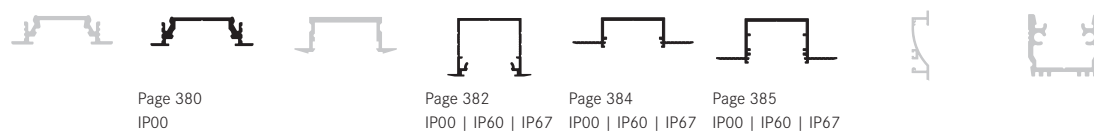

Surface-mounted corner profiles



Special profiles

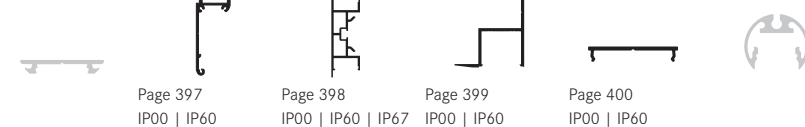

Based on the flex board with protection class IP00 in combination with an opal cover:

- Homogeneous lighting pattern is possible, ■ LED points are visible, no homogeneous lighting pattern, ■ cannot be combined with the flex board
- * = a homogeneous light line is only possible in combination with a high cover

Power supplies



Switchable

Item no. 17243000
LED power supply 24 V DC,
120 W, switchable
 For operation up to 5,000 mm
 (page 534)



Dimmable

Item no. 18190000
RGB+TW radio controller
 For operation from up to 5,000 mm
 (page 552)

**You will find additional
 power supplies and
 controllers from
 page 530 onwards.**



07

QualityFlex Offshore.

Robust LED flex boards for outdoor applications.

Thanks to their polyurethane sheathing, QualityFlex Offshore LED flex boards with protection class IP68 are seawater-proof as well as resistant to UV, solvents and chlorine. Whether used in marine, coastal, home facade, or swimming pool applications, QualityFlex Offshore's LED flex boards can withstand almost any stress. The IP68 connectors with feed line on both sides and low power applications enable a long service life. Matched system components simplify installation.

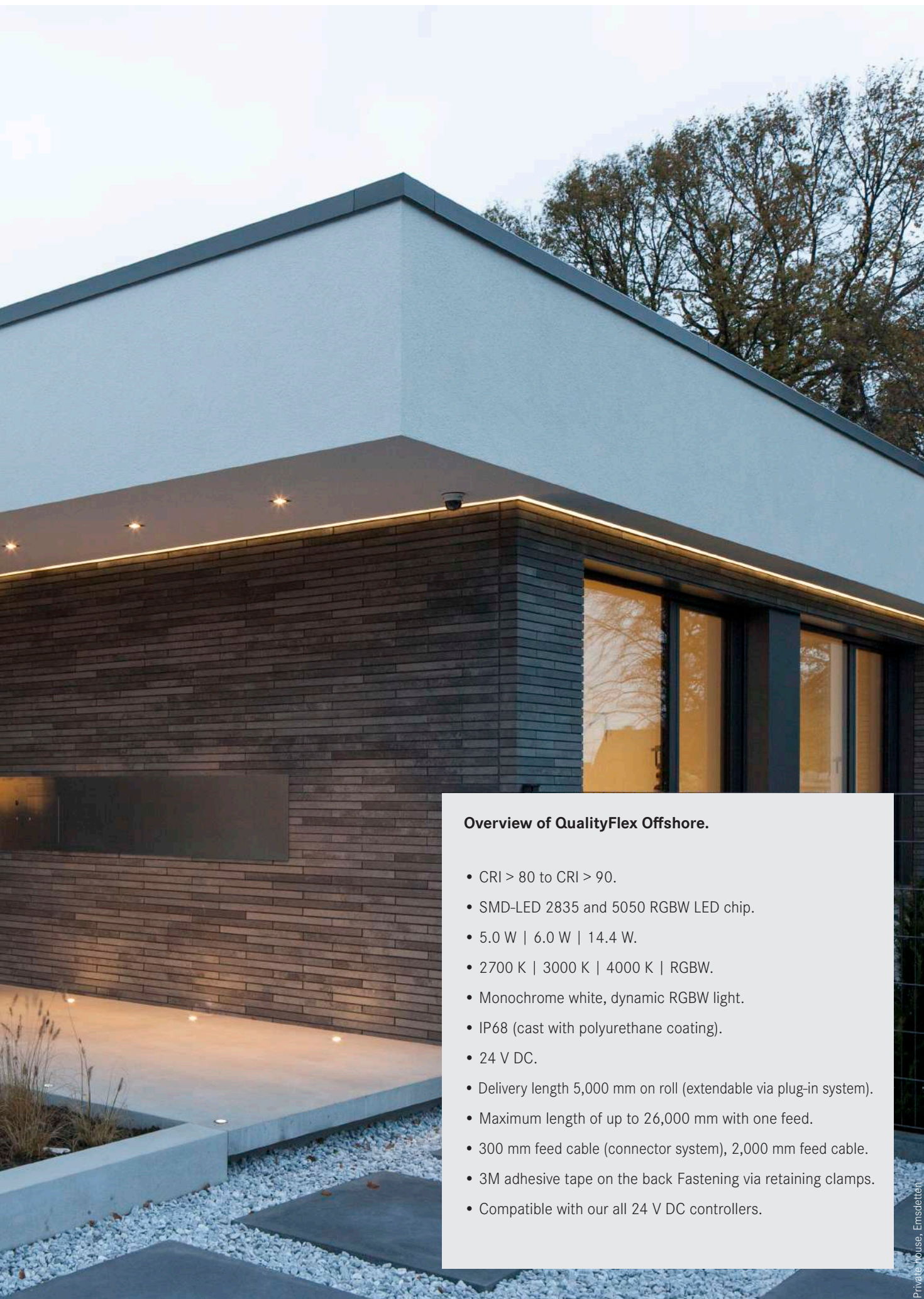

Overview of QualityFlex Offshore.

- CRI > 80 to CRI > 90.
- SMD-LED 2835 and 5050 RGBW LED chip.
- 5.0 W | 6.0 W | 14.4 W.
- 2700 K | 3000 K | 4000 K | RGBW.
- Monochrome white, dynamic RGBW light.
- IP68 (cast with polyurethane coating).
- 24 V DC.
- Delivery length 5,000 mm on roll (extendable via plug-in system).
- Maximum length of up to 26,000 mm with one feed.
- 300 mm feed cable (connector system), 2,000 mm feed cable.
- 3M adhesive tape on the back Fastening via retaining clamps.
- Compatible with our all 24 V DC controllers.

QualityFlex Offshore BIG NEON, RGBW, IP68, 5 W/m

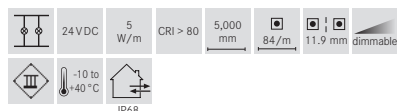

NEW

Electrical data

LED circuit board:	SMD-LED 5050
Power consumption:	5 W/m
Number of LEDs per meter:	84
Rated voltage:	24 VDC
Protection class:	III
Ambient temperature:	-10 to +40 °C
Control:	Negative (5-core)

Photometric data

Color rendering index:	CRI > 80
Color consistency:	SDCM < 3
Efficiency:	85 lm/W at IP68, 4000 K

Light technical data

Beam angle:	120°
-------------	------

Service life:

Service life:	L70/B10: 50,000 h L70/B50: > 50,000 h ta: 25 °C
---------------	---

Mechanical data

Length of the board:	5,000 mm
Maximum module length:	5,000 mm
Pitch dimension:	71.43 mm
Smallest bending radius:	150 mm
Short pitch:	11.90 mm
Connection cable:	1 x 300 mm, with a plug
Self-adhesive:	no
Feed:	from front side

* Special product: Caution! The product with the red, green or blue Color temperature is a special product. This product with these Color temperatures is used for colorful illumination. The spectral distribution of the light is used to change the appearance of illuminated scenes or illuminated objects in addition to making them visible. The product is not intended for use in other applications. The special product is not suitable for room lighting in households.

Key features of the products

- LED flex board with polyurethane sheathing (IP68).
- Exceptionally robust against external influences.
- Optimized for usage in outdoor areas.
- For a play of colors with up to 16 million colors and white light.
- Ideal for terraces, facades and pool areas.
- 5 meter length in one roll.
- Pitch dimension: 71.43 millimeter.
- Compatible with our 4-channel, 24 V DC controllers, RGBW.

Variants of LED flex boards



IP68 | 5 m

Item no.	Price in €	Color temperature	Luminous flux/m	EEK Spectrum A-G	Dimensions [W x H]
19691002	999.00	4000 K	Approximately 106 lm	F	16 x 15 mm
		Red	Approximately 20 lm		
		Green	Approximately 110 lm		
		Blue	Approximately 23 lm		

Can also be manufactured as per the customers' requirements. Please contact us.

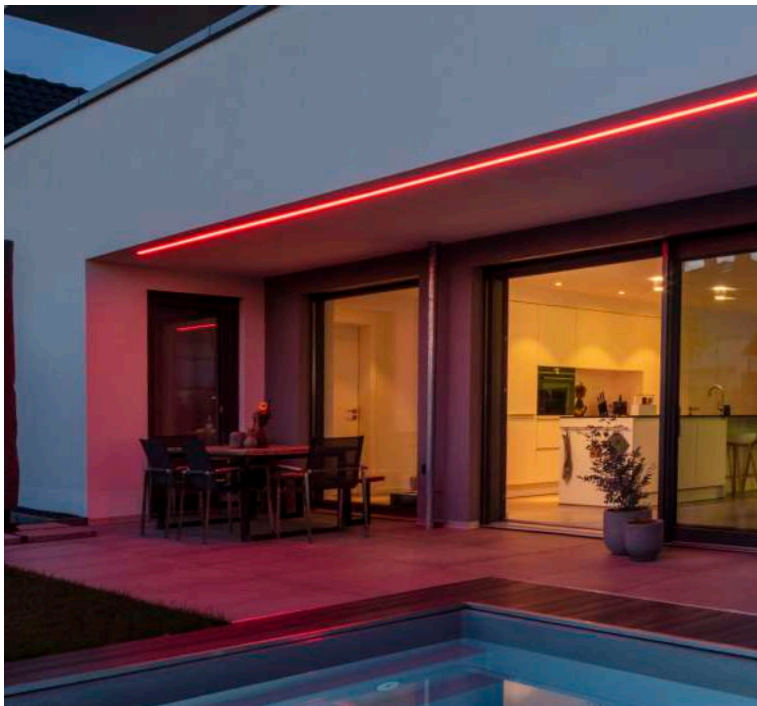

Private house, Kleinwallstadt

Accessories

QualityFlex Offshore BIG NEON aluminum profile

For optional installation, we recommend using the aluminum profile.
 Dimensions: 1,000 x 19.2 x 17.8 mm
 Item number: 53680260
 Price: € 19.90



QualityFlex Offshore BIG NEON plastic profile

Plastic profile, transparent.
 Dimensions: 1,000 x 19.5 x 19.8 mm
 Item number: 53691000
 Price: € 13.80



QualityFlex Offshore BIG NEON fastening clip set

for fastening at radii.
 Content: 15 x brackets, 15 x screws, end caps
 Item number: 53268000
 Price: € 18.60



QualityFlex Offshore connection cable

BIG NEON RGBW
 Including plug and socket,
 Length of the feed line: 5,000 mm,
 Item number: 53690000
 Price: € 142.90



Power supplies



Switchable

Item no. 17241000
LED power supply 24 V DC, 40 W, switchable
 For operation up to 5,000 mm
 (page 534)



Item no. 18223000
RGBW wireless technology control
 For controlling the RGBW LED modules in colored and white light
 Page 546

You will find additional power supplies and controllers from page 530 onwards.

QualityFlex Offshore BIG NEON, IP68, 5 W/m

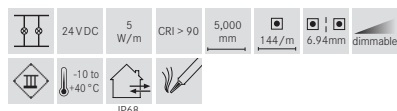

Key features of the products

- LED flex board with polyurethane sheathing (IP68).
- Exceptionally robust against external influences.
- For white light in 2700 Kelvin, 3000 Kelvin and 4000 Kelvin.
- Ideal for terraces, facades and entrance areas.
- Available in length of 5 meters or 1 meter.
- Pitch dimension: 41.67 millimeter.
- Dimmable using suitable accessories.

Electrical data

LED circuit board:	SMD-LED 2835
Power consumption:	5 W/m
Number of LEDs per meter:	144
Rated voltage:	24 VDC
Protection class:	III
Ambient temperature:	-10 to +40 °C

Photometric data

Color rendering index:	CRI > 90
Color consistency:	SDCM < 2
Efficiency:	56 lm/W at IP68, 3000 K

Light technical data

Beam angle:	120°
-------------	------

Service life:

Service life:	L70/B10: 50,000 h L70/B50: > 50,000 h ta: 25 °C
---------------	---

Mechanical data

Length of the board:	5,000 + 1,000 mm
Maximum module length:	26,000 mm
Pitch dimension:	41.67 mm
Smallest bending radius:	150 mm
Short Pitch:	6.94 mm
Connection cable:	2 x 300 mm, with a plug and a coupling for through connection
Self-adhesive:	no
Feed:	from front side

Variants of LED flex boards



Item no.	Price in €	Color temperature	Luminous flux/m	EEK Spectrum A-G	Dimensions [W x H]
19681027	998.00	2700 K	Approximately 280 lm	G	16 x 15 mm
19681003	998.00	3000 K	Approximately 280 lm	G	16 x 15 mm
19681004	998.00	4000 K	Approximately 330 lm	G	16 x 15 mm



Item no.	Price in €	Color temperature	Luminous flux/m	EEK Spectrum A-G	Dimensions [W x H]
19681127	199.00	2700 K	Approximately 280 lm	G	16 x 15 mm
19681103	199.00	3000 K	Approximately 280 lm	G	16 x 15 mm
19681104	199.00	4000 K	Approximately 330 lm	G	16 x 15 mm

Can also be manufactured as per the customers' requirements.
Please contact us.



Accessories

QualityFlex Offshore BIG NEON aluminum profile

For optional installation, we recommend using the aluminum profile.

Dimensions: 1,000 x 19.2 x 17.8 mm

Item number: 53680260

Price: € 19.90



QualityFlex Offshore BIG NEON plastic profile

Plastic profile, transparent.

Dimensions: 1,000 x 19.5 x 19.8 mm

Item number: 53691000

Price: € 13.80



QualityFlex Offshore BIG NEON fastening clip set

for fastening at radii.

Content: 15 x brackets, 15 x screws, end caps

Item number: 53268000

Price: € 18.60



QualityFlex Offshore BIG NEON feed set

as connection with the power supply for Offshore BIG NEON and Offshore BIG NEON sideview.

The set comprises a plug and an IP68 coupling, length of the feed line: 300 mm,

open cores, 2-pin

Item number: 53689000

Price: € 26.40



QualityFlex Offshore BIG NEON connection cable

Simple implementation of through-wiring of multiple QualityFlex Offshore NEON boards.

Including QualityFlex Offshore NEON socket and plug.

Length of connection cable: 1,000 mm

Item number: 53681000

Price: € 29.60



QualityFlex Offshore BIG NEON connection cable

Simple implementation of through-wiring of multiple QualityFlex Offshore Neon boards.

Including QualityFlex Offshore NEON socket and plug.

Length of connection cable: 5,000 mm

Item number: 53685000

Price: € 62.50



Power supplies



Switchable

Item no. 17241000
LED power supply 24 V DC, 40 W, switchable
For operation up to 5,000 mm
(page 534)



Dimmable

Item no. 17528000
White light radio controller
for controlling single-color LED modules in the white light range
Page 543



Dimmable

Item no. 17230000
LED power supply 24 V DC, 30 W, dimmable phase section
For operation up to 5,000 mm
(page 535)

You will find additional power supplies and controllers from page 530 onwards.

QualityFlex Offshore BIG NEON, sideview RGBW, IP68, 5 W/m

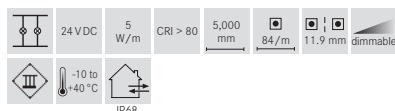
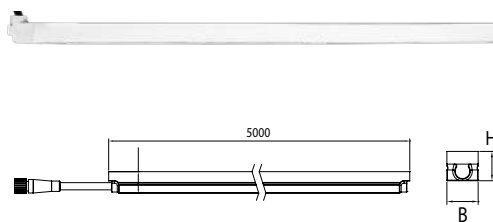

NEW

Electrical data

LED circuit board:	SMD-LED 5050
Power consumption:	5 W/m
Number of LEDs per meter:	84
Rated voltage:	24 V DC
Protection class:	III
Ambient temperature:	-10 to +40 °C
Control:	Negative (5-core)

Photometric data

Color rendering index:	CRI > 80
Color consistency:	SDCM < 3
Efficiency:	56 lm/W at IP68, 4000 K

Light technical data

Beam angle:	120°
-------------	------

Service life:

Service life:	L70/B10: 50,000 h L70/B50: > 50,000 h ta: 25 °C
---------------	---

Mechanical data

Length of the board:	5,000 mm
Maximum module length:	5,000 mm
Pitch dimension:	71.43 mm
Smallest bending radius:	150 mm
Short pitch:	11.90 mm
Connection cable:	1 x 300 mm, with a plug
Self-adhesive:	no
Feed:	from front side

* Special product: Caution! The product with the red, green or blue Color temperature is a special product. This product with these Color temperatures is used for colorful illumination. The spectral distribution of the light is used to change the appearance of illuminated scenes or illuminated objects in addition to making them visible. The product is not intended for use in other applications. The special product is not suitable for room lighting in households.

Key features of the products

- LED flex board with polyurethane sheathing (IP68).
- Exceptionally robust against external influences.
- Optimized for usage in outdoor areas.
- For a play of colors with up to 16 million colors and white light.
- Ideal for terraces, facades and pool areas.
- 5 meter length in one roll.
- Pitch dimension: 71.43 millimeter.
- Compatible with our 4-channel, 24 V DC controllers, RGBW.

Variants of LED flex boards

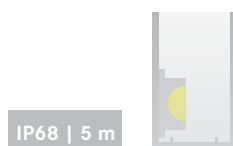

Item no.	Price in €	Color temperature	Luminous flux/m	EELK Spectrum A-G	Dimensions [W x H]
19692002	999.00	4000 K	Approximately 70 lm	G	12 x 20 mm
		Red	Approximately 14 lm		
		Green	Approximately 61 lm		
		Blue	Approximately 12 lm		

Can also be manufactured as per the customers' requirements. Please contact us.



Private house, Kleinwallstadt

Accessories

QualityFlex Offshore BIG NEON sideview aluminum profile

for optional installation, we recommend using the aluminum profile.
 Dimensions: 1,000 x 14.4 x 21.4 mm
 Item number: 53681260
 Price: € 19.90



QualityFlex Offshore BIG NEON flexible profile

Material: Stainless steel, for optional installation at radii.
 Dimensions: 500 x 26.4 x 18 mm
 Item number: 53682260
 Price: € 21.10



QualityFlex Offshore BIG NEON sideview fastening clip set

for fastening at radii.
 Content: 15 x brackets, 15 x screws, end caps
 Item number: 53269000
 Price: € 18.60



QualityFlex Offshore connection cable BIG NEON RGBW

Including plug and socket,
 Length of the feed line: 5,000 mm,
 Item number: 53690000
 Price: € 142.90



Power supplies



Switchable

Item no. 17241000
LED power supply 24 V DC, 40 W, switchable
 For operation up to 5,000 mm
 (page 534)



Item no. 18223000
RGBW wireless technology control
 For controlling the RGBW LED modules in colored and white light.
 Page 546

You will find additional power supplies and controllers from page 530 onwards.

QualityFlex Offshore BIG NEON sideview, IP68, 5 W/m

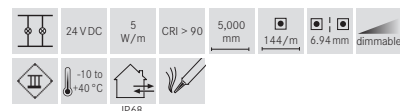
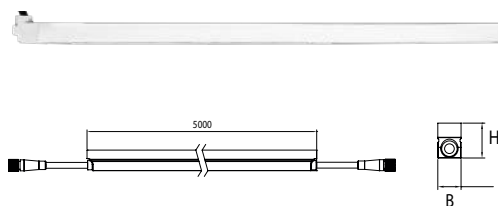

Key features of the products

- LED flex board with polyurethane sheathing (IP68).
- Exceptionally robust against external influences.
- For white light in 2700 Kelvin, 3000 Kelvin and 4000 Kelvin.
- Ideal for terraces, facades and entrance areas.
- Laterally directed LEDs for horizontal light emission.
- Available in length of 5 meters or 1 meter.
- Pitch dimension: 41.67 millimeter.
- Dimmable using suitable accessories.

Electrical data

LED circuit board:	SMD-LED 2835
Power consumption:	5 W/m
Number of LEDs per meter:	144
Rated voltage:	24 V DC
Protection class:	III
Ambient temperature:	-10 to +40 °C

Photometric data

Color rendering index:	CRI > 90
Color consistency:	SDCM < 2
Efficiency:	52 lm/W at IP68, 3000 K

Light technical data

Beam angle:	120°
-------------	------

Service life:

Service life:	L70/B10: 50,000 h L70/B50: > 50,000 h ta: 25 °C
---------------	---

Mechanical data

Length of the board:	5,000 + 1,000 mm
Maximum module length:	23,000 mm
Pitch dimension:	41.67 mm
Smallest bending radius:	150 mm
Short Pitch:	6.94 mm
Connection cable:	2 x 300 mm, with a plug and a coupling for through connection
Self-adhesive:	no
Feed:	from front side

Variants of LED flex boards



Item no.	Price in €	Color temperature	Luminous flux/m	EEK Spectrum A-G	Dimensions [W x H]
19682027	998.00	2700 K	Approximately 228 lm	G	12 x 20 mm
19682003	998.00	3000 K	Approximately 262 lm	G	12 x 20 mm
19682004	998.00	4000 K	Approximately 264 lm	G	12 x 20 mm



Item no.	Price in €	Color temperature	Luminous flux/m	EEK Spectrum A-G	Dimensions [W x H]
19682127	199.00	2700 K	Approximately 228 lm	G	12 x 20 mm
19682103	199.00	3000 K	Approximately 262 lm	G	12 x 20 mm
19682104	199.00	4000 K	Approximately 264 lm	G	12 x 20 mm

Can also be manufactured as per the customers' requirements.
Please contact us.



Accessories

QualityFlex Offshore BIG NEON sideview aluminum profile
 For optional installation, we recommend using the aluminum profile.
 Dimensions: 1,000 x 14.4 x 21.4 mm
 Item number: 53681260
 Price: € 19.90



QualityFlex Offshore BIG NEON flexible profile
 Material: Stainless steel, for optional installation at radii.
 Dimensions: 500 x 26.4 x 18 mm
 Item number: 53682260
 Price: € 21.10



QualityFlex Offshore BIG NEON sideview fastening clip set
 for fastening at radii.
 Content: 15 x brackets, 15 x screws, end caps
 Item number: 53269000
 Price: € 18.60



QualityFlex Offshore BIG NEON feed set
 as connection with the power supply for Offshore BIG NEON and Offshore BIG NEON sideview.
 The set comprises a plug and an IP68 coupling, length of the feed line: 300 mm, open cores, 2-pin
 Item number: 53689000
 Price: € 26.40



QualityFlex Offshore NEON connection cable
 Simple implementation of through-wiring of multiple QualityFlex Offshore BIG NEON boards.
 Including QualityFlex Offshore BIG NEON socket and plug.
 Length of connection cable: 1,000 mm
 Item number: 53681000
 Price: € 29.60



QualityFlex Offshore BIG NEON connection cable
 Simple implementation of through-wiring of multiple QualityFlex Offshore BIG NEON boards.
 Including QualityFlex Offshore BIG NEON socket and plug.
 Length of connection cable: 5,000 mm
 Item number: 53685000
 Price: € 62.50



Power supplies



Switchable

Item no. 17241000
LED power supply 24 V DC, 40 W, switchable
 For operation up to 5,000 mm
 (page 534)



Dimmable

Item no. 17528000
White light radio controller
 for controlling single-color LED modules in the white light range
 Page 543



Dimmable

Item no. 17230000
LED power supply 24 V DC, 30 W, dimmable phase section
 For operation up to 5,000 mm
 (page 535)

You will find additional power supplies and controllers from page 530 onwards.

QualityFlex Offshore NEON CORONA, IP68, 5 W/m

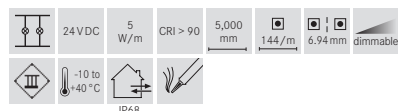
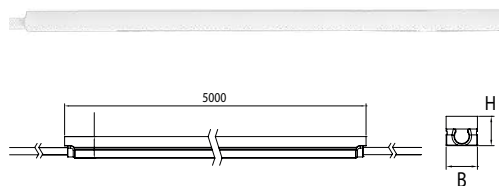

Key features of the products

- LED flex board with polyurethane sheathing (IP68).
- Exceptionally robust against external influences.
- For white light in 2700 Kelvin, 3000 Kelvin and 4000 Kelvin.
- Low luminous intensity for decorative illumination of niches, heels or parts of facades.
- Available in length of 5 meters or 1 meter.
- Pitch dimension: 41.67 millimeter.
- Dimmable using suitable accessories.



Electrical data

LED circuit board:	SMD-LED 2835
Power consumption:	5 W/m
Number of LEDs per meter:	144
Rated voltage:	24 VDC
Protection class:	III
Ambient temperature:	-10 to +40 °C

Photometric data

Color rendering index:	CRI > 90
Color consistency:	SDCM < 2
Efficiency:	69 lm/W at IP68, 3000 K

Light technical data

Beam angle:	180°
-------------	------

Service life:

Service life:	L70/B10: 50,000 h L70/B50: > 50,000 h ta: 25 °C
---------------	---

Mechanical data

Length of the board:	1,000 mm
Maximum module length:	19,000 mm
Pitch dimension:	41.67 mm
Smallest bending radius:	75 mm
Short Pitch:	6.94 mm
Connection cable:	2,000 mm, open core ends
Self-adhesive:	no
Feed:	from front side

Variants of LED flex boards

IP68 5 m					
Item no.	Price in €	Color temperature	Luminous flux/m	EEK Spectrum A-G	Dimensions [W x H]
19683027	649.00	2700 K	Approximately 336 lm	G	10 x 10 mm
19683003	649.00	3000 K	Approximately 346 lm	G	10 x 10 mm
19683004	649.00	4000 K	Approximately 406 lm	F	10 x 10 mm

IP68 1 m					
Item no.	Price in €	Color temperature	Luminous flux/m	EEK Spectrum A-G	Dimensions [W x H]
19683127	129.00	2700 K	Approximately 336 lm	G	10 x 10 mm
19683103	129.00	3000 K	Approximately 346 lm	G	10 x 10 mm
19683104	129.00	4000 K	Approximately 406 lm	F	10 x 10 mm

Can also be manufactured as per the customers' requirements.
Please contact us.



Private house, Augsburg

Accessories

QualityFlex Offshore NEON CORONA aluminum profile

For optional installation, we recommend using the aluminum profile.

Dimensions: 1,000 x 12.4 x 12.9 mm

Item number: 53683260

Price: € 18.00



QualityFlex Offshore NEON CORONA fastening clip set

for fastening at radii.

Content: 15 x brackets, 15 x screws, end caps

Item number: 53270000

Price: € 20.20



Power supplies



Switchable

Item no. 17241000
LED power supply 24 V DC,
40 W, switchable
 For operation up to 5,000 mm
 (page 534)



Dimmable

Item no. 17528000
White light radio controller
 for controlling single-color LED
 modules in the white light range
 Page 543



Dimmable

Item no. 17230000
LED power supply 24 V DC,
30 W, dimmable phase section
 For operation up to 5,000 mm
 (page 535)

**You will find additional
 power supplies and
 controllers from
 page 530 onwards.**

QualityFlex Offshore MINI NEON sideview, IP68, 5 W/m

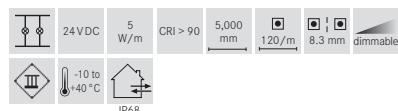
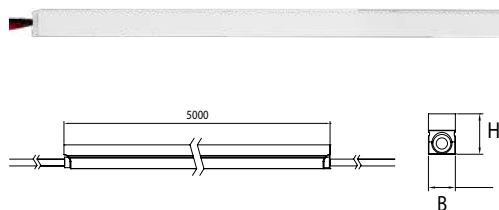

Key features of the products

- LED flex board with polyurethane sheathing (IP68).
- Exceptionally robust against external influences.
- For white light in 2700 Kelvin, 3000 Kelvin and 4200 Kelvin.
- Exceptionally slim LED flex boards for the illumination of edges, joints or heels.
- Decorative illumination for terraces and facades.
- Available in length of 5 meters or 1 meter.
- Dimmable using suitable accessories.

Electrical data

LED circuit board:	SMD-LED 2835
Power consumption:	5 W/m
Number of LEDs per meter:	120
Rated voltage:	24 VDC
Protection class:	III
Ambient temperature:	-10 to +40 °C

Photometric data

Color rendering index:	CRI > 90
Color consistency:	SDCM < 2
Efficiency:	57 lm/W at IP68, 3000 K

Light technical data

Beam angle:	120°
-------------	------

Service life:

Service life:	L70/B10: 50,000 h L70/B50: > 50,000 h ta: 25 °C
---------------	---

Mechanical data

Length of the board:	5,000 mm
Maximum module length:	5,000 mm
Pitch dimension:	50 mm
Smallest bending radius:	30 mm
Short Pitch:	8.3 mm
Connection cable:	2,000 mm, open core ends
Self-adhesive:	no
Feed:	from front side

Variants of LED flex boards



IP68 | 5 m

Item no. 5,000 mm	Price in €	Color temperature	Luminous flux/m	EEK Spectrum A-G	Dimensions [W x H]
19684027	689.00	2700 K	Approximately 280 lm	G	6.5 x 12 mm
19684003	689.00	3000 K	Approximately 288 lm	G	6.5 x 12 mm
19684004	689.00	4200 K	Approximately 280 lm	G	6.5 x 12 mm

IP68 | 1 m

Item no. 1 m	Price in €	Color temperature	Luminous flux/m	EEK Spectrum A-G	Dimensions [W x H]
19684127	139.00	2700 K	Approximately 280 lm	G	6.5 x 12 mm
19684103	139.00	3000 K	Approximately 288 lm	G	6.5 x 12 mm
19684104	139.00	4200 K	Approximately 280 lm	G	6.5 x 12 mm

Can also be manufactured as per the customers' requirements. Please contact us.



Private house, Vredan

Accessories

QualityFlex Offshore MINI NEON sideview aluminum profile,
 For optional installation, we recommend using the aluminum profile.
 Dimensions: 1,000 x 8.9 x 13.2 mm
 Item number: 53684260
 Price: € 15.80



QualityFlex Offshore MINI NEON sideview flexible profile
 Material: Stainless steel, for optional installation at radii,
 Dimensions: 500 x 20.5 x 12 mm
 Item number: 53685260
 Price: € 18.00



QualityFlex Offshore MINI NEON sideview fastening clip set
 for installation at radii.
 Content: 15 x brackets, 15 x screws, end caps
 Item number: 53271000
 Price: € 20.20



Power supplies



Switchable

Item no. 17241000
LED power supply 24 V DC,
40 W, switchable
 For operation up to 5,000 mm
 (page 534)



Dimmable

Item no. 17528000
White light radio controller
 for controlling single-color LED
 modules in the white light range
 Page 543



Dimmable

Item no. 17230000
LED power supply 24 V DC,
30 W, dimmable phase section
 For operation up to 5,000 mm
 (page 535)

**You will find additional
 power supplies and
 controllers from
 page 530 onwards.**

QualityFlex Offshore CLEAR, CRI > 90, IP68, 6 W/m

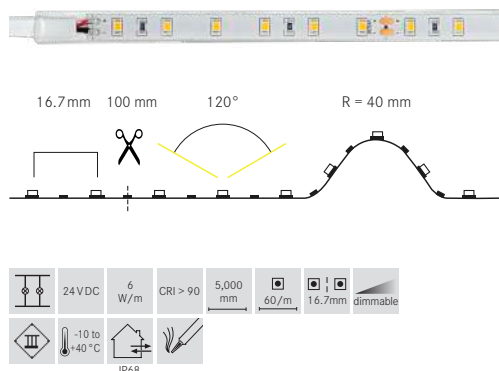

Key features of the products

- LED flex board with polyurethane sheathing (IP68).
- Exceptionally robust against external influences.
- For white light in 2700 Kelvin, 3000 Kelvin and 4000 Kelvin.
- Ideal for terraces, facades and entrance areas.
- Pleasant light accents and dignified ambience thanks to power of 6 Watt/meter.
- Available in length of 5 meters.
- Dimmable using suitable accessories.

Electrical data

LED circuit board:	SMD-LED 2835
Power consumption:	6 W/m
Number of LEDs per meter:	60
Rated voltage:	24 VDC
Protection class:	III
Ambient temperature:	-10 to +40 °C

Photometric data

Color rendering index:	CRI > 90
Color consistency:	SDCM < 3
Efficiency:	68 lm/W at IP68, 3000 K

Light technical data

Beam angle:	120°
-------------	------

Service life:

Service life:	L80/B10: 25,000 h L70/B10: > 36,000 h ta: 25 °C
---------------	---

Mechanical data

Length of the board:	5,000 mm
Maximum module length:	5,000 mm
Pitch dimension:	100 mm
Smallest bending radius:	40 mm
Short Pitch:	16.7 mm
Connection cable:	2 x 2,000 mm
Self-adhesive:	yes

For heat dissipation, it is absolutely necessary to mount on aluminum profiles.

Variants of LED flex boards



Item no.	Price in €	Color temperature	Luminous flux/m	EEL Spectrum A-G	Dimensions [W x H]
19685027	299.00	2700 K	Approximately 400lm	G	10 x 5 mm
19685003	299.00	3000 K	Approximately 405lm	G	10 x 5 mm
19685004	299.00	4000 K	Approximately 440lm	G	10 x 5 mm

Can also be manufactured as per the customers' requirements. Please contact us.

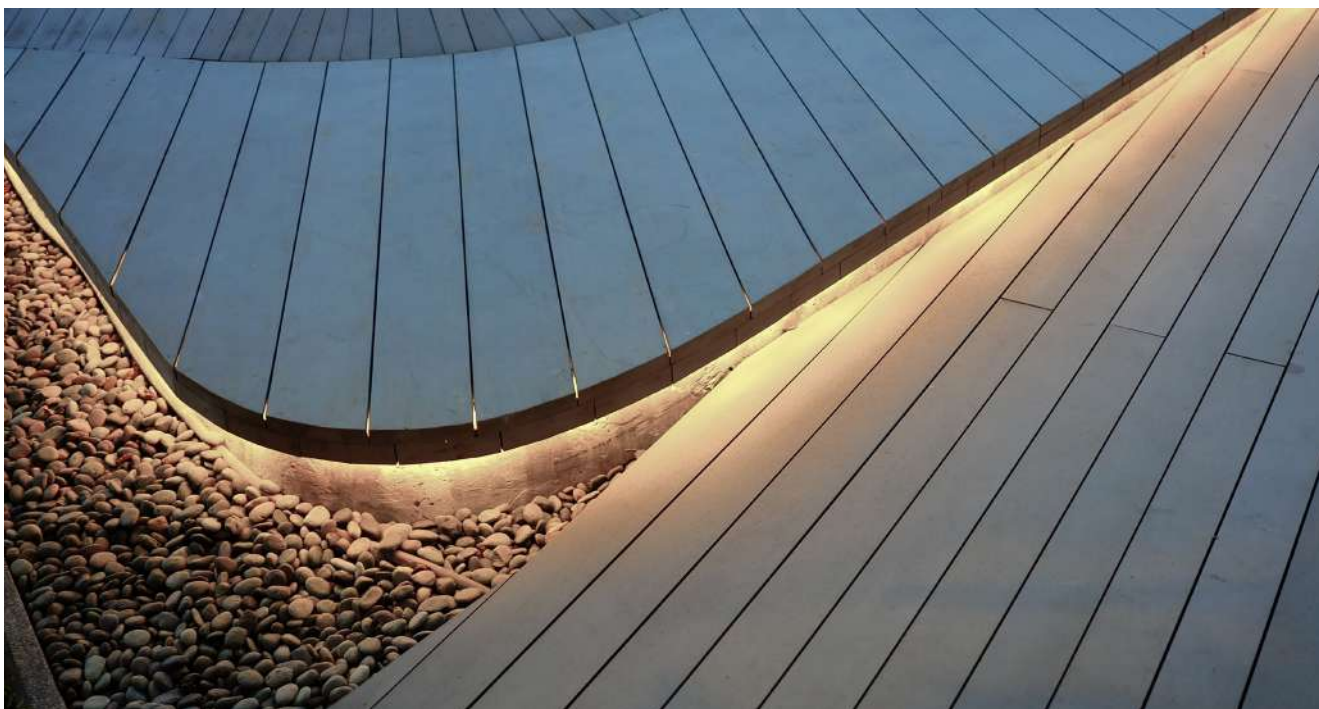

Profile overview

Surface-mounted profiles



Recessed profiles

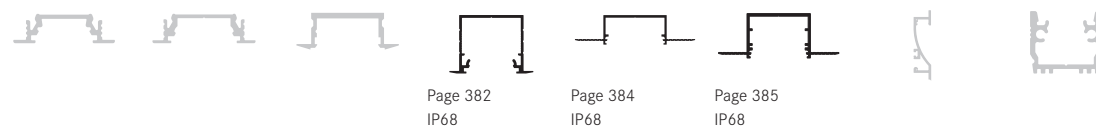

Surface-mounted corner profiles



Special profiles

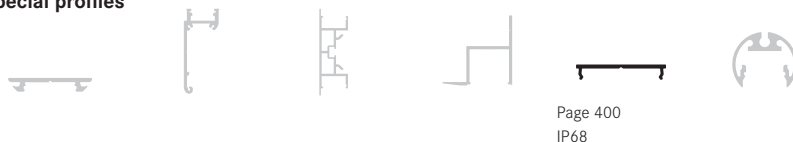

Based on the flex board with protection class IP00 in combination with an opal cover:

■ Homogeneous lighting pattern is possible, ■ LED points are visible, no homogeneous lighting pattern, ■ cannot be combined with the flex board

* = a homogeneous light line is only possible in combination with a high cover

Power supplies



Switchable

Item no. 17241000
LED power supply 24 V DC, 40 W, switchable
 For operation up to 5,000 mm
 (page 534)



Dimmable

Item no. 17528000
White light radio controller
 for controlling single-color LED modules in the white light range
 Page 543



Dimmable

Item no. 17230000
LED power supply 24 V DC, 30 W, dimmable phase section
 For operation up to 5,000 mm
 (page 535)

You will find additional power supplies and controllers from page 530 onwards.

QualityFlex Offshore CLEAR, CRI > 90, IP68, 14.4 W/m

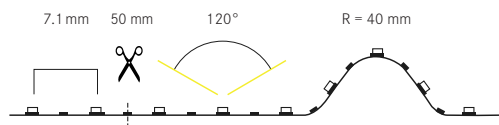

	24 VDC		14.4 W/m		CRI > 90		5,000 mm		140/m		7.1 mm		dimmable
	-10 to +40 °C		IP68										

Key features of the products

- LED flex board with polyurethane sheathing (IP68).
- Exceptionally robust against external influences.
- For white light in 2700 Kelvin, 3000 Kelvin and 4000 Kelvin.
- Ideal for terraces, facades and entrance areas.
- Expressive light lines that make the building shine.
- Available in length of 5 meters.
- Dimmable using suitable accessories.

Electrical data

LED circuit board:	SMD-LED 2835
Power consumption:	14.4 W/m
Number of LEDs per meter:	140
Rated voltage:	24 VDC
Protection class:	III
Ambient temperature:	-10 to +40 °C

Photometric data

Color rendering index:	CRI > 90
Color consistency:	SDCM < 3
Efficiency:	67 lm/W at IP68, 3000 K

Light technical data

Beam angle:	120°
-------------	------

Service life:

Service life:	L80/B10: 25,000 h L70/B10: > 36,000 h ta: 25 °C
---------------	---

Mechanical data

Length of the board:	5,000 mm
Maximum module length:	5,000 mm
Pitch dimension:	50 mm
Smallest bending radius:	40 mm
Short Pitch:	7.1 mm
Connection cable:	2 x 2,000 mm
Self-adhesive:	yes

For heat dissipation, it is absolutely necessary to mount on aluminum profiles.

Variants of LED flex boards



Item no. 5,000 mm	Price in €	Color temperature	Luminous flux/m	EEL Spectrum A-G	Dimensions [W x H]
19686027	399.00	2700 K	Approximately 960 lm	G	12 x 5 mm
19686003	399.00	3000 K	Approximately 970 lm	G	12 x 5 mm
19686004	399.00	4000 K	Approximately 1,050 lm	G	12 x 5 mm

Can also be manufactured as per the customers' requirements. Please contact us.



Klinsterdorf (Artists' Village), Schöppingen

Profile overview

Surface-mounted profiles



Recessed profiles

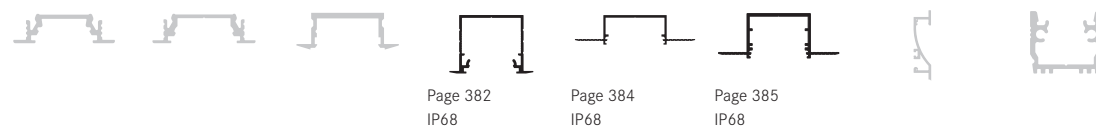

Surface-mounted corner profiles



Special profiles

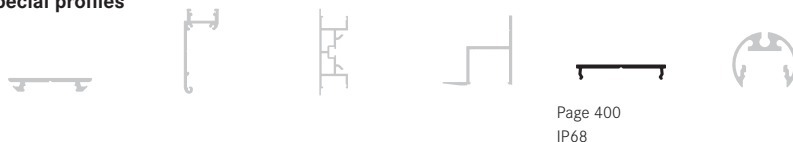

Based on the flex board with protection class IP00 in combination with an opal cover:

- Homogeneous lighting pattern is possible, ■ LED points are visible, no homogeneous lighting pattern, ■ cannot be combined with the flex board
- * = a homogeneous light line is only possible in combination with a high cover

Power supplies



Switchable

Item no. 17243000
LED power supply 24 V DC, 120 W, switchable
 For operation up to 5,000 mm
 (page 534)



Dimmable

Item no. 17528000
White light radio controller
 for controlling single-color LED modules in the white light range
 Page 543



Dimmable

Item no. 17231000
LED power supply 24 V DC, 75 W, dimmable phase section
 For operation up to 5,000 mm
 (page 535)

You will find additional power supplies and controllers from page 530 onwards.



07

QualityFlex aluminum profiles.

Suitable solution for every installation situation.

Surface-mounted profiles
Recessed profiles
Corner profiles

Page 366
Page 379
Page 388

Special profiles
Complete profile set

Page 394
Page 402



Hotel WDK, Bad Frideburg

Surface-mounted profile P01-10

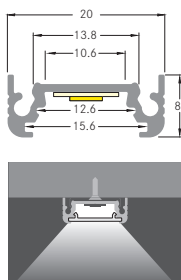

Advantages of surface-mounted profile:

- Flat and compact surface-mounted profile.
- Available in white and anodized aluminum colors.
- Up to 4-meter length in one piece.
- Extensive accessories.
- Connecting piece 90° for rectangular application.

Finished length

Item no.	Lengths	Color	Price in €
53600260	2,000 mm	Aluminum anodized	24.90
53600070	2,000 mm	Painted in white	31.00

Assembly up to a maximum of 4,000 mm

Item no.	Assembly	Price in €
73600260	Aluminum profile 100 mm, anodized aluminum	1.70
73600070	Aluminum profile 100 mm, painted in white	2.10
73991000	Cut-out of the aluminum profile	5.80

In case of delivery lengths beyond 2,000 mm: Please inquire for delivery costs separately.

Click cover: PMMA

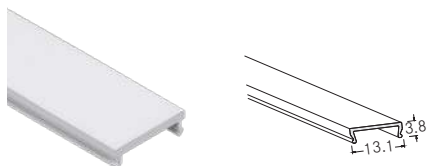

Finished length

Item no.	Lengths	Color	Price in €
53400000	2,000 mm	Transparent	15.40
53400070	2,000 mm	Opal	15.40

Assembly up to a maximum of 4,000 mm

Item no.	Assembly	Price in €
73400000	Cover 100 mm, transparent	1.10
73400070	Cover 100 mm, opal	1.10
73992000	Cut-out of cover	5.30

Bracket set



Item no.	Color	Price in €
53001000	Silver	3.40

Comprising 2 brackets.

Connecting piece 180°



Item no.	Color	Price in €
53005000	Raw aluminum	3.50

Connecting piece 90°

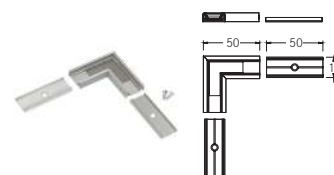

Item no.	Color	Price in €
53051260	Aluminum anodized	19.90
53051070	Painted in white	21.10

End caps set



Item no.	Color	Price in €
53110260	Silver	1.60
53110070	White	1.60

Surface-mounted profile P02-10

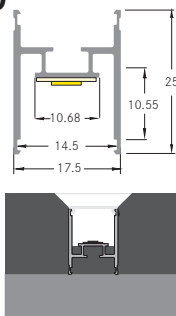

Advantages of surface-mounted profile:

- High surface-mounted profile.
- Available in black and anodized aluminum colors.
- Up to 6-meter length in one piece.
- High-quality accessories.
- Covers on a roll, up to 80 m in one piece.
- Connecting piece for optimum extension of profiles to a line.

Finished length

Item no.	Lengths	Color	Price in €
53605260	2,000 mm	Aluminum anodized	35.30
53605080	2,000 mm	Black anodized	50.80

Assembly up to a maximum of 6,000 mm

Item no.	Assembly	Price in €
73605260	Aluminum profile 100 mm, anodized aluminum	2.50
73605080	Aluminum profile 100 mm, black anodized	3.20
73991000	Cut-out of the aluminum profile	5.80

In case of delivery lengths beyond 2,000 mm: Please inquire for delivery costs separately.

Flex-click cover: PC

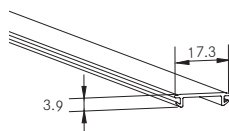

Up to 80 meters* in one roll



* On request

Finished length

Item no.	Lengths	Color	Price in €
53440000	2,000 mm	Transparent	30.70
53440070	2,000 mm	Opal	30.70
53440080	2,000 mm	Black	44.50

Assembly

Item no.	Assembly	Price in €
73440000	Cover 100 mm, transparent	2.10
73440070	Cover 100 mm, opal	2.10
73440080	Cover 100 mm, black	3.10
73992000	Cut-out of cover	5.30

Bracket set

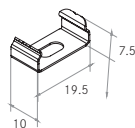

Item no.	Color	Price in €
53034000	Silver	6.20

Comprising 2 brackets.

Connecting piece 180°

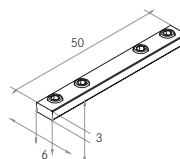

Item no.	Color	Price in €
53030000	Raw aluminum	14.90

End caps set

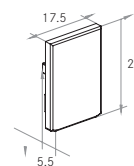

Item no.	Color	Price in €
53087260	Aluminum	23.60
53087080	Black	27.60

Surface-mounted profile P03-12

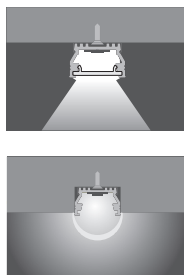
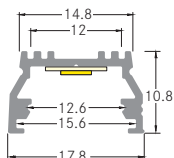

Advantages of surface-mounted profile:

- Medium-high surface-mounted profile.
- Up to 4-meter length in one piece.
- Very extensive accessory.
- Connecting piece 90° for rectangular application.
- Semi-circular cover for a wide light emission.

Finished length

Item no.	Lengths	Color	Price in €
53601260	2,000 mm	Aluminum anodized	23.70

Assembly up to a maximum of 4,000 mm

Item no.	Assembly	Price in €
73601260	Aluminum profile 100 mm, anodized aluminum	1.60
73991000	Cut-out of the aluminum profile	5.80

In case of delivery lengths beyond 2,000 mm:
Please inquire for delivery costs separately.

Click cover: PMMA

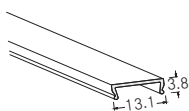

Finished length

Item no.	Lengths	Color	Price in €
53400000	2,000 mm	Transparent	15.40
53400070	2,000 mm	Opal	15.40

Assembly up to a maximum of 4,000 mm

Item no.	Assembly	Price in €
73400000	Cover 100 mm, transparent	1.10
73400070	Cover 100 mm, opal	1.10
73992000	Cut-out of cover	5.30

Click cover: PMMA

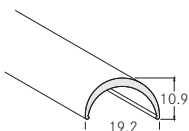

Finished length

Item no.	Lengths	Color	Price in €
53431070	2,000 mm	Opal	22.90

Assembly up to a maximum of 4,000 mm

Item no.	Assembly	Price in €
73431070	Cover 100 mm, opal	1.50
73992000	Cut-out of cover	5.30

Bracket set

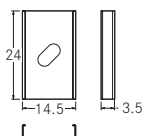

Item no.	Color	Price in €
53001000	Silver	3.40

Comprising 2 brackets.

Connecting piece 90°

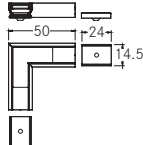

Item no.	Color	Price in €
53067260	Aluminum anodized	19.30

End caps set for 53400...

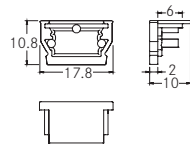

Item no.	Color	Price in €
53052260	Silver	2.70

End caps set for 53431070

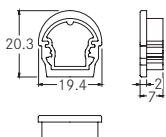

Item no.	Color	Price in €
53053260	Silver	2.70

Surface-mounted profile P04-14

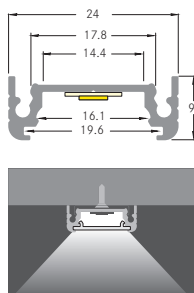

Advantages of surface-mounted profile:

- Flat surface-mounted profile.
- Available in white, black and anodized aluminum colors.
- Up to 4-meter in one piece.
- Connecting piece 90° for rectangular application.
- Extensive accessories and suitable covers.

Finished length

Item no.	Lengths	Color	Price in €
53602260	2,000 mm	Aluminum anodized	26.80
53602070	2,000 mm	Painted in white	36.90
53602080	2,000 mm	Black anodized	36.90

Assembly up to a maximum of 4,000 mm

Item no.	Assembly	Price in €
73602260	Aluminum profile 100 mm, anodized aluminum	1.90
73602070	Aluminum profile 100 mm, painted in white	2.60
73602080	Aluminum profile 100 mm, black anod.	2.60
73991000	Cut-out of the aluminum profile	5.80

In case of delivery lengths beyond 2,000 mm: Please inquire for delivery costs separately.

Click cover: PMMA

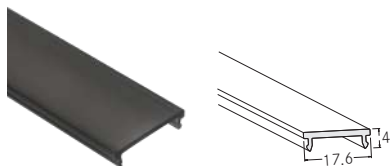

Finished length

Item no.	Lengths	Color	Price in €
53402000	2,000 mm	Transparent	18.70
53402070	2,000 mm	Opal	18.70
53402080	2,000 mm	Black	18.70

Assembly up to a maximum of 4,000 mm

Item no.	Assembly	Price in €
73402000	Cover 100 mm, transparent	1.30
73402070	Cover 100 mm, opal	1.30
73402080	Cover 100 mm, black	1.30
73992000	Cut-out of cover	5.30

Bracket set

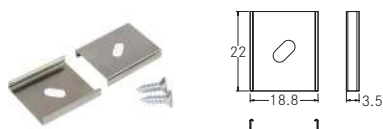

Item no.	Color	Price in €
53003000	Silver	4.30

Comprising 2 brackets.

Connecting piece 180°



Item no.	Color	Price in €
53004000	Raw aluminum	3.40

Connecting piece 90°

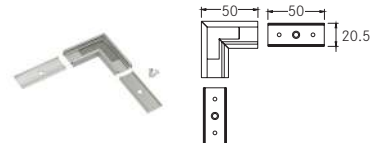

Item no.	Color	Price in €
53055260	Aluminum anodized	21.10
53055070	Painted in white	21.80
53055080	Black anodized	21.80

End caps set



Item no.	Color	Price in €
53114260	Silver	1.90
53114070	White	1.90
53114080	Black	1.90

Surface-mounted profile P05-14

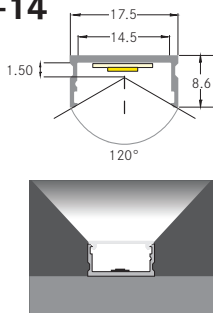

Advantages of surface-mounted profile:

- Simple and compact surface-mounted profile.
- Good to use for displays.
- Up to 6-meter length in one piece.
- Suitable covers are available in transparent, opal and black.
- Covers on a roll, up to 80 m in one piece.

Finished length

Item no.	Lengths	Color	Price in €
53604260	2,000 mm	Aluminum anodized	23.90
53604080	2,000 mm	Black anodized	26.30

Assembly up to a maximum of 6,000 mm

Item no.	Assembly	Price in €
73604260	Aluminum profile 100 mm, anodized aluminum	1.60
73604080	Aluminum profile 100 mm, black anodized	1.70
73991000	Cut-out of the aluminum profile	5.80

**In case of delivery lengths beyond 2,000 mm:
Please inquire for delivery costs separately.**

Flex-click cover: PC

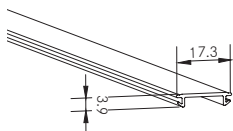

Up to 80 meters* in one roll



* On request

Finished length

Item no.	Lengths	Color	Price in €
53440000	2,000 mm	Transparent	30.70
53440070	2,000 mm	Opal	30.70
53440080	2,000 mm	Black	44.50

Assembly

Item no.	Assembly	Price in €
73440000	Cover 100 mm, transparent	2.10
73440070	Cover 100 mm, opal	2.10
73440080	Cover 100 mm, black	3.10
73992000	Cut-out of cover	5.30

Bracket set

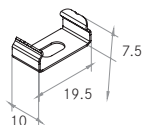

Item no.	Color	Price in €
53034000	Silver	6.20

Comprising 2 brackets.

End caps set

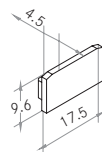

Item no.	Color	Price in €
53086070	White	16.00
53086080	Black	16.00

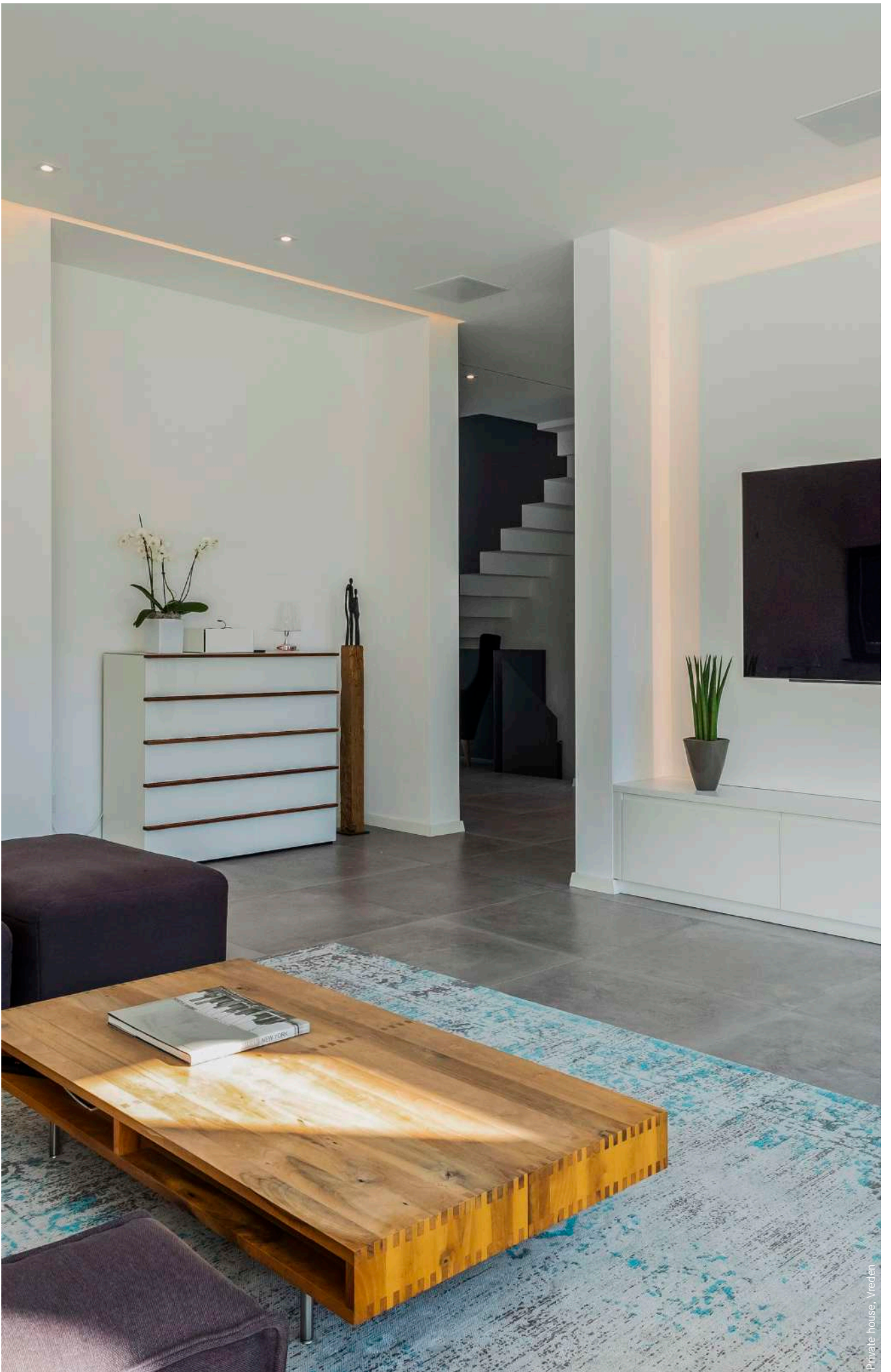

Private house, Vredem

Surface-mounted profile P06-20

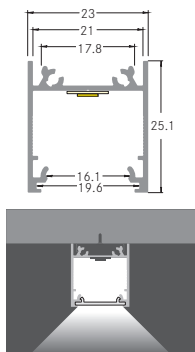

Advantages of surface-mounted profile:

- Up to 4-meter length in one piece.
- Suitable covers are available in transparent, opal and black.
- Surface-mounted profile can also be used as a pendant variant.
- Large light emission due to height offset cover.
- For every cover, we offer matching end caps.

Finished length

Item no.	Lengths	Color	Price in €
53603260	2,000 mm	Aluminum anodized	33.40
53603070	2,000 mm	Painted in white	51.90
53603080	2,000 mm	Black anodized	51.90

Assembly up to a maximum of 4,000 mm

Item no.	Assembly	Price in €
73603260	Aluminum profile 100 mm, anodized aluminum	2.30
73603070	Aluminum profile 100 mm, painted in white	3.50
73603080	Aluminum profile 100 mm, black anod.	3.50
73991000	Cut-out of the aluminum profile	5.80

In case of delivery lengths beyond 2,000 mm: Please inquire for delivery costs separately.

Click cover: PMMA

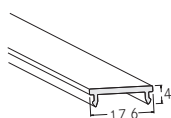

Finished length

Item no.	Lengths	Color	Price in €
53402000	2,000 mm	Transparent	18.70
53402070	2,000 mm	Opal	18.70
53402080	2,000 mm	Black	18.70

Assembly up to a maximum of 4,000 mm

Item no.	Assembly	Price in €
73402000	Cover 100 mm, transparent	1.30
73402070	Cover 100 mm, opal	1.30
73402080	Cover 100 mm, black	1.30
73992000	Cut-out of cover	5.30

Click cover: PMMA

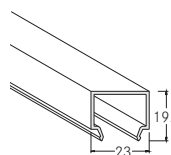

Finished length

Item no.	Lengths	Color	Price in €
53432070	2,000 mm	Opal	45.50

Assembly up to a maximum of 4,000 mm

Item no.	Assembly	Price in €
73432070	Cover 100 mm, opal	3.00
73992000	Cut-out of cover	5.30

Bracket set

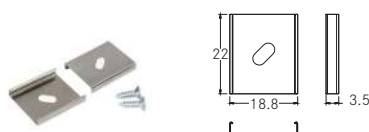

Item no.	Color	Price in €
53003000	Silver	4.30

Comprising 2 brackets.

Connecting piece 180°



Item no.	Color	Price in €
53007000	Raw aluminum + transparent	9.80

Connecting piece 90°

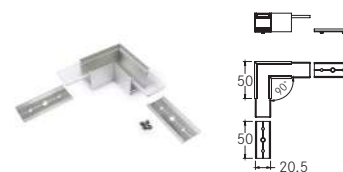

Item no.	Color	Price in €
53059260	Aluminum anodized	28.20
53059070	Painted in white	28.20
53059080	Black anodized	28.20

Screw set for End caps set 53057... (4 pieces)



Item no.	Color	Price in €
53058260	Silver	2.40
53058070	White	2.40
53058080	Black	2.40

End caps set for 53402...



Item no.	Color	Price in €
53057260	Silver	3.70
53057070	White	3.70
53057080	Black	3.70

End caps set for 53432070

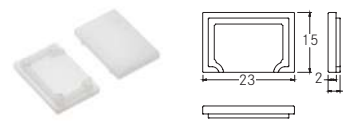

Item no.	Color	Price in €
53056070	Opal	4.40

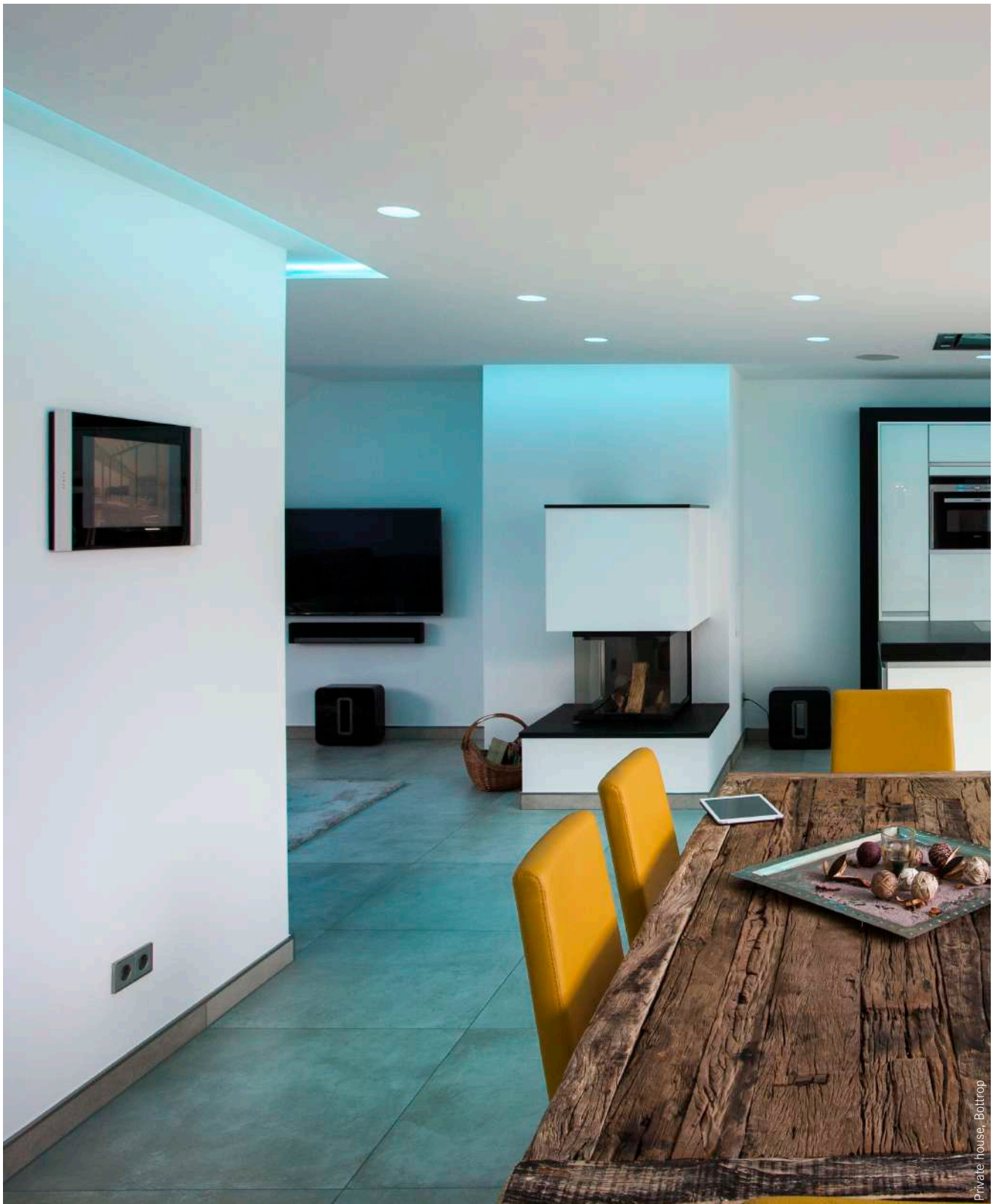

Private House, Bottrop

**End caps set for 53603...
with cover 53432070**



Item no.	Color	Price in €
53063260	Silver	4.10
53063070	White	4.10
53063080	Black	4.10

**Rear cover plate
for profile 53603...**



In combination with rope suspension 53006000.

Mounting by insertion.

Item no.	Length	Color	Price in €
53756260	2,000 mm	Aluminum anodized	17.20
53756070	2,000 mm	Painted in white	22.90
53756080	2,000 mm	Black anodized	22.90

**Rope suspension set,
1,500 mm**



Item no.	Color	Price in €
53006000	Chromium	39.50

Rope thickness: 1 mm
Content: 2 pieces

Sizes in mm | All specified prices are non-binding recommended retail prices (RRP) in euros excluding VAT.
Errors subject to change. | Orders are subject to our General Terms and Conditions of Sale printed from page 592 onwards.

Surface-mounted profile P16-16

NEW

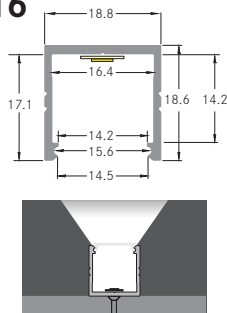

Advantages of surface-mounted profile:

- Simple surface-mounted profile
- Available in black and anodized aluminum colors.
- Up to 4-meter length in one piece.
- Extensive accessories.
- Covers on a roll, up to 80 meters in one piece.

Finished length

Item no.	Lengths	Color	Price in €
53607260	2,000 mm	Aluminum anodized	42.00
53607080	2,000 mm	Black anodized	46.00

Assembly up to a maximum of 4,000 mm

Item no.	Assembly	Price in €
73607260	Aluminum profile 100 mm, anodized aluminum	2.70
73607080	Aluminum profile 100 mm, black anodized	2.90
73991000	Cut-out of the aluminum profile	5.80

In case of delivery lengths beyond 2,000 mm:
Please inquire for delivery costs separately.

Flex-click cover: PC

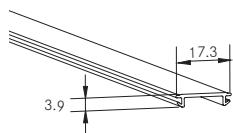

Up to 80 meters* in one roll



* On request

Finished length

Item no.	Lengths	Color	Price in €
53440000	2,000 mm	Transparent	30.70
53440070	2,000 mm	Opal	30.70
53440080	2,000 mm	Black	44.50

Assembly

Item no.	Assembly	Price in €
73440000	Cover 100 mm, transparent	2.10
73440070	Cover 100 mm, opal	2.10
73440080	Cover 100 mm, black	3.10
73992000	Cut-out of cover	5.30

Bracket set

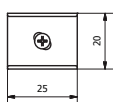

Item no.	Color	Price in €
53027260	Aluminum	2.30
53027080	Black	2.30

Comprising 2 brackets.

End caps set

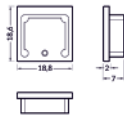

Item no.	Color	Price in €
53089260	Aluminum	1.80
53089080	Black	1.80

BB surface-mounted profile, flat

NEW

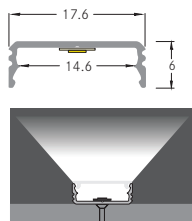

Advantages

of surface-mounted profile:

- Flat, economic surface-mounted profile.
- Profile and corresponding covers are available in lengths of 1 meter, 2 meters and 3 meters.
- Optimum heat dissipation for durable illumination.

Finished length

Item no.	Lengths	Color	Price in €
53380261	1,000 mm	Aluminum anodized	6.80
53380262	2,000 mm	Aluminum anodized	12.90
53380263	3,000 mm	Aluminum anodized	20.60

Flex-click cover: PC

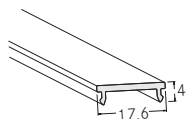

Finished length

Item no.	Lengths	Color	Price in €
53489001	1,000 mm	Transparent	4.30
53489071	1,000 mm	Opal	4.30
53489002	2,000 mm	Transparent	8.70
53489072	2,000 mm	Opal	8.70
53489003	3,000 mm	Transparent	13.80
53489073	3,000 mm	Opal	13.80

Bracket set



Item no.	Color	Price in €
53040000	Aluminum	2.20

Comprising 2 brackets.

End caps set



Item no.	Color	Price in €
53038260	Silver	1.70

BB surface-mounted profile, high

NEW

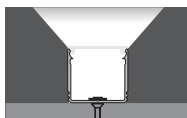
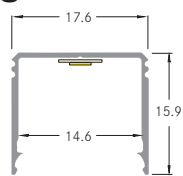
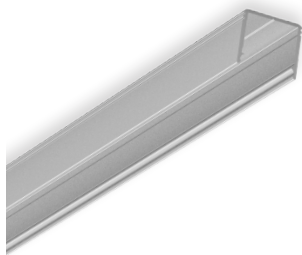

Advantages of surface-mounted profile:

- High, economic surface-mounted profile.
- Profile and corresponding covers are available in lengths of 1 meter, 2 meters and 3 meters.
- Optimum heat dissipation for durable illumination.

Finished length

Item no.	Lengths	Color	Price in €
53381261	1,000 mm	Aluminum anodized	11.40
53381262	2,000 mm	Aluminum anodized	21.20
53381263	3,000 mm	Aluminum anodized	34.00

Flex-click cover: PC

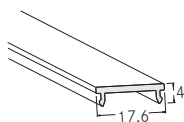

Finished length

Item no.	Lengths	Color	Price in €
53489001	1,000 mm	Transparent	4.30
53489071	1,000 mm	Opal	4.30
53489002	2,000 mm	Transparent	8.70
53489072	2,000 mm	Opal	8.70
53489003	3,000 mm	Transparent	13.80
53489073	3,000 mm	Opal	13.80

Bracket set



Item no.	Color	Price in €
53040000	Aluminum	2.20

Comprising 2 brackets.

End caps set



Item no.	Color	Price in €
53039260	Silver	2.50

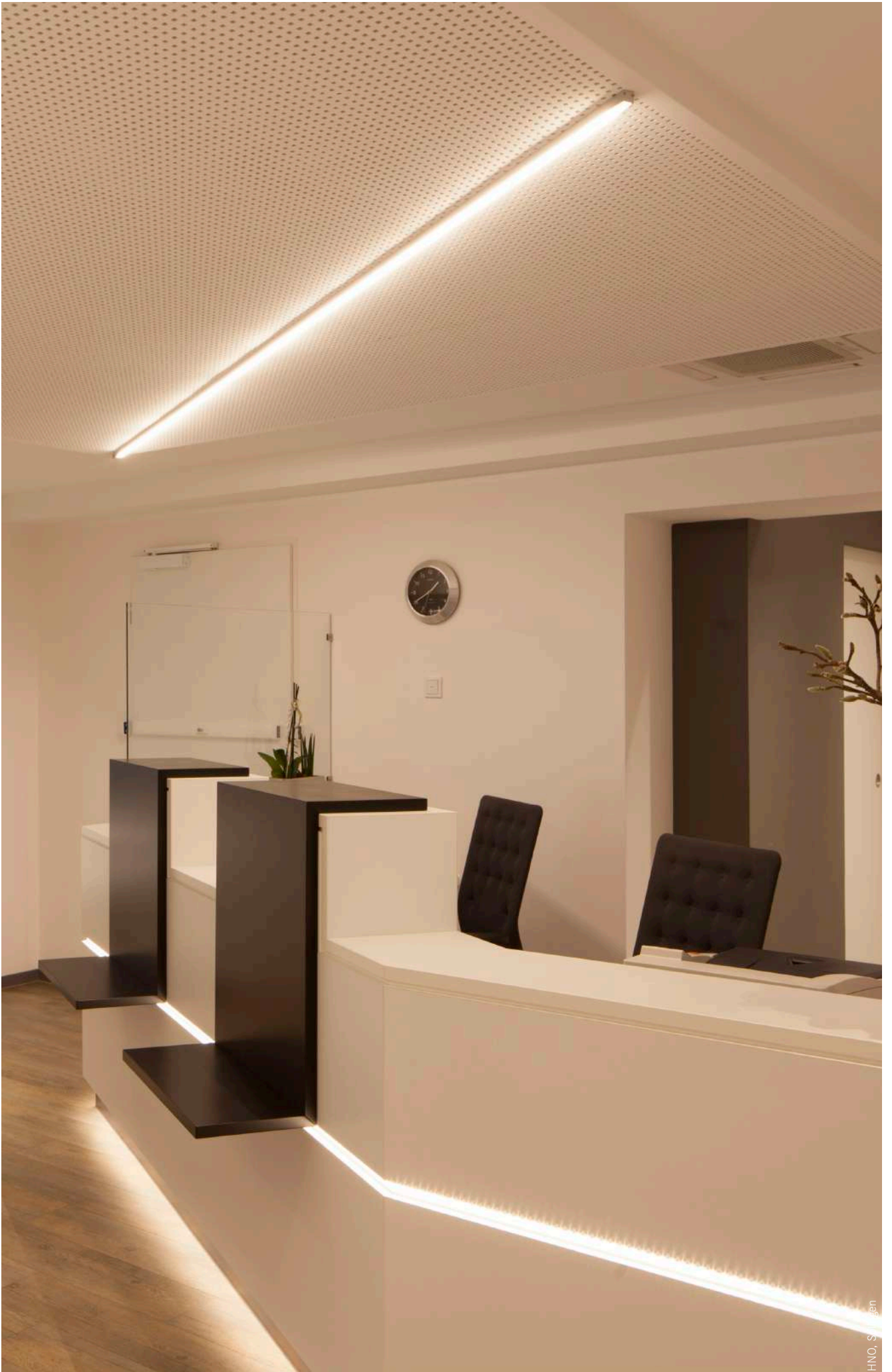

HNO, S. gen

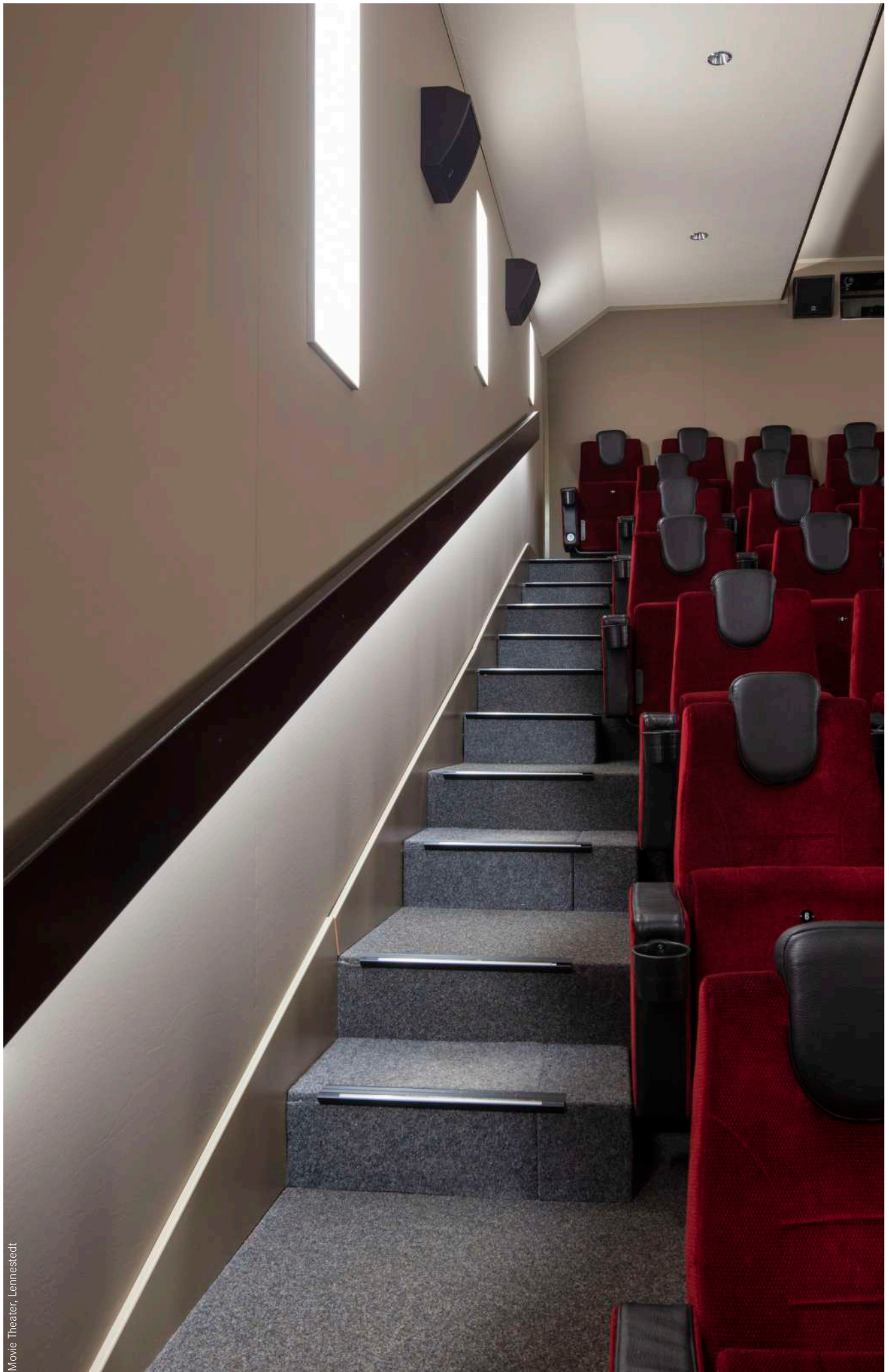

Movie Theater, Lennestedt

Recessed profile P31-10

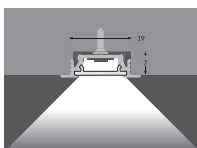
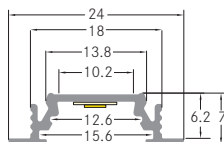

Advantages of recessed profile:

- Flat and compact recessed profile.
- Connecting piece 90° for rectangular application.
- Available in white and anodized aluminum colors.
- Up to 4-meter length in one piece.
- Extensive accessories.

Finished length

Item no.	Lengths	Color	Price in €
53651260	2,000 mm	Aluminum anodized	23.40
53651070	2,000 mm	Painted in white	31.30

Assembly up to a maximum of 4,000 mm

Item no.	Assembly	Price in €
73651260	Aluminum profile 100 mm, anodized aluminum	1.60
73651070	Aluminum profile 100 mm, painted in white	2.20
73991000	Cut-out of the aluminum profile	5.80

In case of delivery lengths beyond 2,000 mm:
Please inquire for delivery costs separately.

Click cover: PMMA

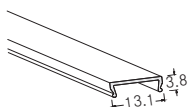

Finished length

Item no.	Lengths	Color	Price in €
53400000	2,000 mm	Transparent	15.40
53400070	2,000 mm	Opal	15.40

Assembly up to a maximum of 4,000 mm

Item no.	Assembly	Price in €
73400000	Cover 100 mm, transparent	1.10
73400070	Cover 100 mm, opal	1.10
73992000	Cut-out of cover	5.30

Bracket set

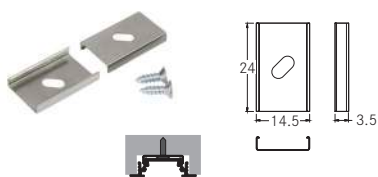

Item no.	Color	Price in €
53001000	Silver	3.40

Comprising 2 brackets.

Bracket set with tothing

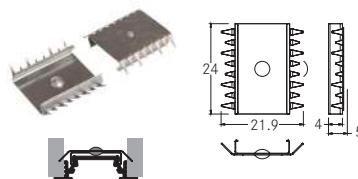

Item no.	Color	Price in €
53002000	Silver	10.90

Comprising 2 brackets.

Spring holder for hollow ceilings

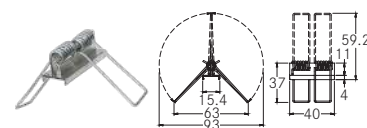

Item no.	Color	Price in €
53008000	Raw aluminum	5.20

Connecting piece 180°



Item no.	Color	Price in €
53005000	Raw aluminum	3.50

Connecting piece 90°

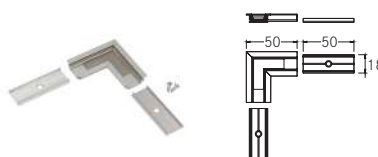

Item no.	Color	Price in €
53061260	Aluminum anodized	19.80
53061070	Painted in white	20.50

End caps set



Item no.	Color	Price in €
53161260	Silver	1.60
53161070	White	1.60

Recessed profile P34-14

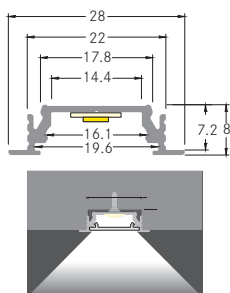

Advantages of recessed profile:

- Flat recessed profile.
- Connecting piece 90° for rectangular application.
- Available in white, black and anodized aluminum colors.
- Up to 4-meter length in one piece.
- Suitable covers are available in transparent, opal and black.

Finished length

Item no.	Lengths	Color	Price in €
53653260	2,000 mm	Aluminum anodized	26.90
53653070	2,000 mm	Painted in white	38.70
53653080	2,000 mm	Black anodized	38.70

Assembly up to a maximum of 4,000 mm

Item no.	Assembly	Price in €
73653260	Aluminum profile 100 mm, anodized aluminum	1.90
73653070	Aluminum profile 100 mm, painted in white	2.70
73653080	Aluminum profile 100 mm, black anod.	2.70
73991000	Cut-out of the aluminum profile	5.80

In case of delivery lengths beyond 2,000 mm: Please inquire for delivery costs separately.

Click cover: PMMA

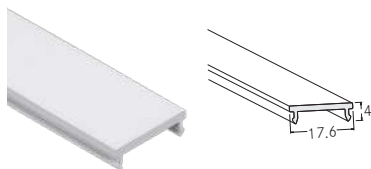

Finished length

Item no.	Lengths	Color	Price in €
53402000	2,000 mm	Transparent	18.70
53402070	2,000 mm	Opal	18.70
53402080	2,000 mm	Black	18.70

Assembly up to a maximum of 4,000 mm

Item no.	Assembly	Price in €
73402000	Cover 100 mm, transparent	1.30
73402070	Cover 100 mm, opal	1.30
73402080	Cover 100 mm, black	1.30
73992000	Cut-out of cover	5.30

Click cover: PMMA

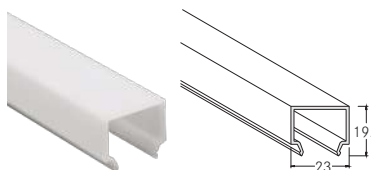

Finished length

Item no.	Lengths	Color	Price in €
53432070	2,000 mm	Opal	45.50

Assembly up to a maximum of 4,000 mm

Item no.	Assembly	Price in €
73432070	Cover 100 mm, opal	3.00
73992000	Cut-out of cover	5.30

Bracket set

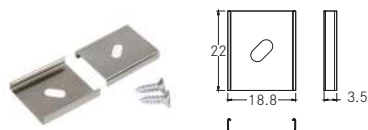

Item no.	Color	Price in €
53003000	Silver	4.30

Comprising 2 brackets.

Connecting piece 180°



Item no.	Color	Price in €
53004000	Raw aluminum	3.40

Connecting piece 90°

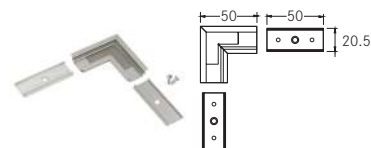

Item no.	Color	Price in €
53065260	Aluminum anodized	20.90
53065070	Painted in white	21.60
53065080	Black anodized	21.60

End caps set for 53402...

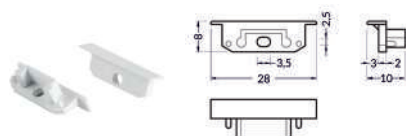

Item no.	Color	Price in €
53164260	Silver	1.90
53164070	White	1.90
53164080	Black	1.90

End caps set for 53432070

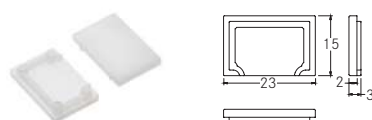

Item no.	Color	Price in €
53056070	Opal	4.40

Recessed profile P35-14

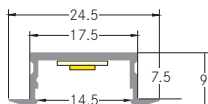

Advantages of recessed profile:

- Simple and compact recessed profile.
- Available in black and anodized aluminum colors.
- Up to 6 meters in one piece.
- Suitable covers are available in transparent, opal and black.
- Covers on a roll, up to 80 meters in one piece.

Finished length

Item no.	Lengths	Color	Price in €
53657260	2,000 mm	Aluminum anodized	26.20
53657080	2,000 mm	Black anodized	27.40

Assembly up to a maximum of 6,000 mm

Item no.	Assembly	Price in €
73657260	Aluminum profile 100 mm, anodized aluminum	1.90
73657080	Aluminum profile 100 mm, black anodized	1.90
73991000	Cut-out of the aluminum profile	5.80

**In case of delivery lengths beyond 2,000 mm:
Please inquire for delivery costs separately.**

Flex-click cover: PC

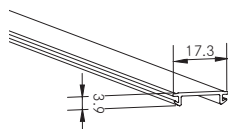

Up to 80 meters* in one roll



* On request

Finished length

Item no.	Lengths	Color	Price in €
53440000	2,000 mm	Transparent	30.70
53440070	2,000 mm	Opal	30.70
53440080	2,000 mm	Black	44.50

Assembly

Item no.	Assembly	Price in €
73440000	Cover 100 mm, transparent	2.10
73440070	Cover 100 mm, opal	2.10
73440080	Cover 100 mm, black	3.10
73992000	Cut-out of cover	5.30

Bracket set

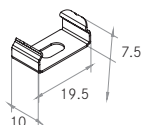

Item no.	Color	Price in €
53034000	Silver	6.20

Comprising 2 brackets.

End caps set

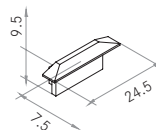

Item no.	Color	Price in €
53088260	Aluminum	23.60
53088080	Black	27.50

Recessed profile P36-20

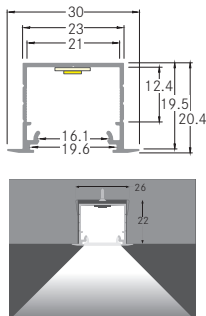

Advantages of recessed profile:

- Available in white, black and anodized aluminum colors.
- Up to 4-meter length in one piece.
- Large light emission due to height offset cover.
- For every cover, we offer matching end caps.

Finished length

Item no.	Lengths	Color	Price in €
53654260	2,000 mm	Aluminum anodized	36.60
53654070	2,000 mm	Painted in white	41.10
53654080	2,000 mm	Black anodized	41.10

Assembly up to a maximum of 4,000 mm

Item no.	Assembly	Price in €
73654260	Aluminum profile 100 mm, anodized aluminum	2.90
73654070	Aluminum profile 100 mm, painted in white	2.90
73654080	Aluminum profile 100 mm, black anod.	2.90
73991000	Cut-out of the aluminum profile	5.80

In case of delivery lengths beyond 2,000 mm: Please inquire for delivery costs separately.

Click cover: PMMA

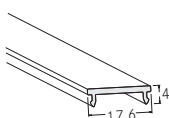

Finished length

Item no.	Lengths	Color	Price in €
53402000	2,000 mm	Transparent	18.70
53402070	2,000 mm	Opal	18.70
53402080	2,000 mm	Black	18.70

Assembly up to a maximum of 4,000 mm

Item no.	Assembly	Price in €
73402000	Cover 100 mm, transparent	1.30
73402070	Cover 100 mm, opal	1.30
73402080	Cover 100 mm, black	1.30
73992000	Cut-out of cover	5.30

Click cover: PMMA

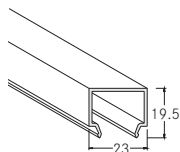

Finished length

Item no.	Lengths	Color	Price in €
53432070	2,000 mm	Opal	45.50

Assembly up to a maximum of 4,000 mm

Item no.	Assembly	Price in €
73432070	Cover 100 mm, opal	3.00
73992000	Cut-out of cover	5.30

Bracket set

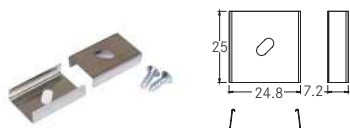

Item no.	Color	Price in €
53010000	Silver	5.50

Comprising 2 brackets.

Bracket set with toothing

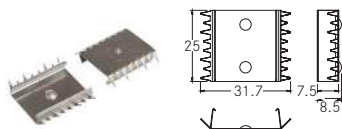

Item no.	Color	Price in €
53011000	Silver	17.90

Comprising 2 brackets.

Spring bracket set for low ceilings (2 pieces)

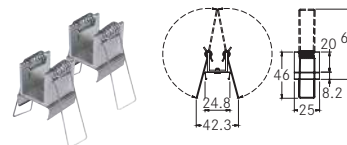

Item no.	Color	Price in €
53012000	Raw aluminum	15.90

Connecting piece 180°



Item no.	Material	Price in €
53013000	Polycarbonate	13.40

Connecting piece 90°



Item no.	Color	Price in €
53069260	Aluminum anodized	25.50
53069070	Painted in white	28.00
53069080	Black anodized	28.00

End caps set for 53402...

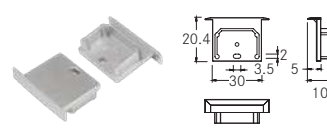

Item no.	Color	Price in €
53066260	Silver	4.40
53066070	White	4.40
53066080	Black	4.40



Private Cinema, Reichenbach

End caps set for 53432070

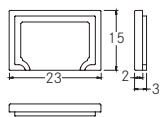

Item no.	Color	Price in €
53056070	Opal	4.40

Flush-mounted profile P37-30

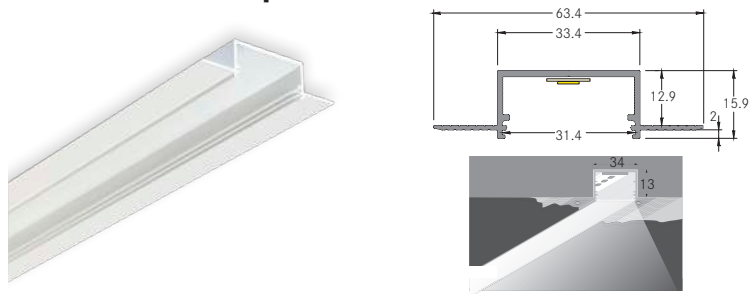

Advantages of flush-mounted profile:

- Elegant, compact flush-mounted profile for the ceiling mounting.
- Fluted surface for better grip when plastering the surface.
- Up to 4-meter length in one piece.
- Simple installation due to additional screw mounting.

Finished length

Item no.	Lengths	Color	Price in €
53655070	2,000 mm	Painted in white	68.90

Assembly up to a maximum of 4,000 mm

Item no.	Assembly	Price in €
73655070	Aluminum profile 100 mm, painted in white	4.40
73991000	Cut-out of the aluminum profile	5.80

**In case of delivery lengths beyond 2,000 mm:
Please inquire for delivery costs separately.**

Cover: PMMA

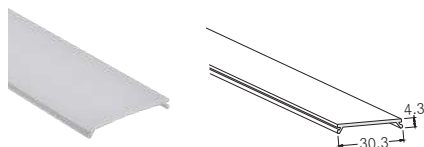

Finished length

Item no.	Lengths	Color	Price in €
53404000	2,000 mm	Transparent	27.40
53404070	2,000 mm	Opal	27.40

Assembly up to a maximum of 4,000 mm

Item no.	Assembly	Price in €
73404000	Cover 100 mm, transparent	1.90
73404070	Cover 100 mm, opal	1.90
73992000	Cut-out of cover	5.30

End caps set

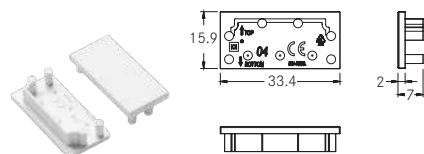

Item no.	Color	Price in €
53091070	White	4.10

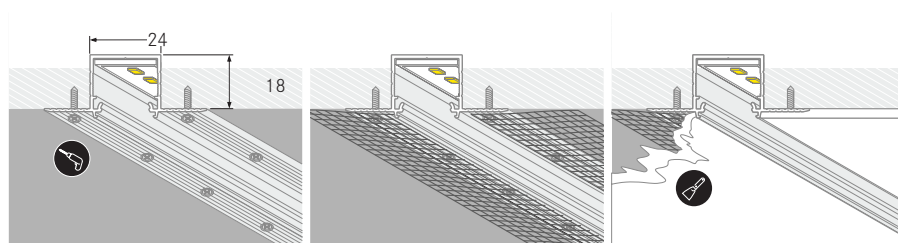

Mounting recommendations:

1. Pre-drill the wing
2. Fasten using a countersunk head screw
3. Plastering

Flush-mounted profile P38-30

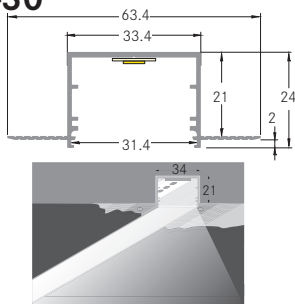

Advantages of flush-mounted profile:

- Elegant, deep flush-mounted profile for the ceiling mounting.
- Fluted surface for better grip when plastering the surface.
- Small visible aluminum edge when installed.
- Owing to the depth of the profile, all Brumberg Select boards achieve a homogeneous light pattern.

Finished length

Item no.	Lengths	Color	Price in €
53656070	2,000 mm	Painted in white	77.40

Assembly up to a maximum of 4,000 mm

Item no.	Assembly	Price in €
73656070	Aluminum profile 100 mm, painted in white	5.00
73991000	Cut-out of the aluminum profile	5.80

**In case of delivery lengths beyond 2,000 mm:
Please inquire for delivery costs separately.**

Cover: PMMA

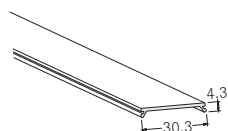

Finished length

Item no.	Lengths	Color	Price in €
53404000	2,000 mm	Transparent	27.40
53404070	2,000 mm	Opal	27.40

Assembly up to a maximum of 4,000 mm

Item no.	Assembly	Price in €
73404000	Cover 100 mm, transparent	1.90
73404070	Cover 100 mm, opal	1.90
73992000	Cut-out of cover	5.30

End caps set

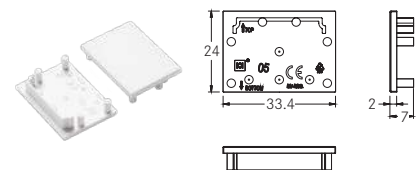

Item no.	Color	Price in €
53092070	White	5.10

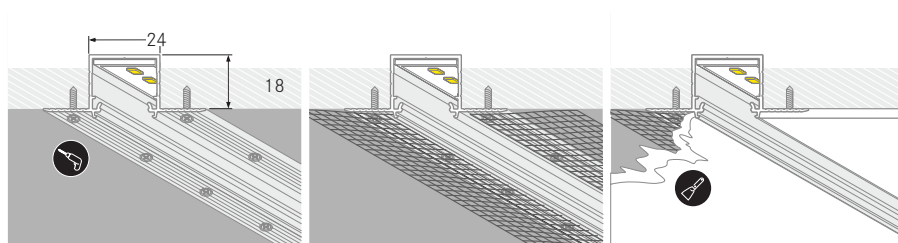

Mounting recommendations:

1. Pre-drill the wing
2. Fasten using a countersunk head screw
3. Plastering

Wall-mounted recessed profile P32-12

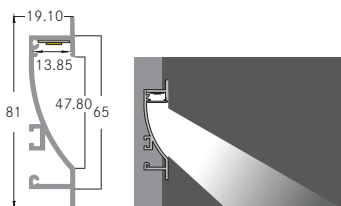

Advantages

of wall-mounted recessed profile:

- Especially suitable for the illumination of walls, niches and corridors.
- Up to 6-meter length in one piece.
- Direct floor illumination due to 45° beam angle.
- Covers on a roll, up to 80 meters in one piece.
- Designed for installation in gypsum plasterboards.

Finished length

Item no.	Lengths	Color	Price in €
53650260	2,000 mm	Aluminum anodized	72.40

Assembly up to a maximum of 6,000 mm

Item no.	Assembly	Price in €
73650260	Aluminum profile 100 mm, anodized aluminum	4.90
73991000	Cut-out of the aluminum profile	5.80

**In case of delivery lengths beyond 2,000 mm:
Please inquire for delivery costs separately.**

Flex-click cover: PC

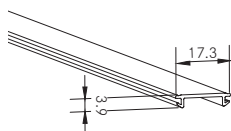

Up to 80 meters* in one roll



* On request

Finished length

Item no.	Lengths	Color	Price in €
53440000	2,000 mm	Transparent	30.70
53440070	2,000 mm	Opal	30.70
53440080	2,000 mm	Black	44.50

Assembly

Item no.	Assembly	Price in €
73440000	Cover 100 mm, transparent	2.10
73440070	Cover 100 mm, opal	2.10
73440080	Cover 100 mm, black	3.10
73992000	Cut-out of cover	5.30

Connecting piece 180°

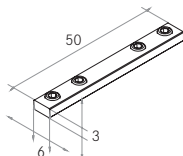

Item no.	Color	Price in €
53030000	Raw aluminum	14.90

Spring holder for hollow walls

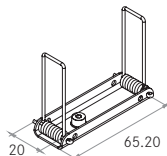

Item no.	Color	Price in €
53032000	Raw aluminum	57.90

End caps set

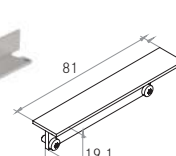

Item no.	Color	Price in €
53068260	Aluminum anodized	52.00

Floor recessed profile P33-12

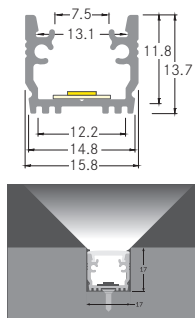

Advantages of floor recessed profile:

- Floor recessed profile only for the private indoor areas.
- Solid design.
- Up to 4-meter length in one piece.
- For integration into domestic floors.
- Extensive accessories.

Finished length

Item no.	Lengths	Color	Price in €
53652260	2,000 mm	Aluminum anodized	33.40

Assembly up to a maximum of 4,000 mm

Item no.	Assembly	Price in €
73652260	Aluminum profile 100 mm, anodized aluminum	2.30
73991000	Cut-out of the aluminum profile	5.80

**In case of delivery lengths beyond 2,000 mm:
Please inquire for delivery costs separately.**

Click cover: PC

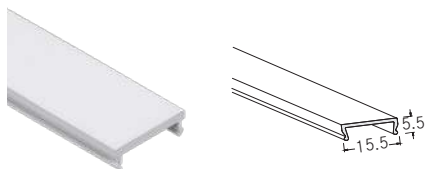

Finished length

Item no.	Lengths	Color	Price in €
53401070	2,000 mm	Opal	41.60

Assembly up to a maximum of 4,000 mm

Item no.	Assembly	Price in €
73401070	Cover 100 mm, opal	2.80
73992000	Cut-out of cover	5.30

Bracket set

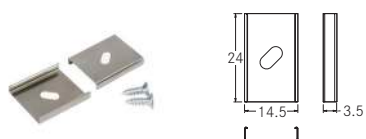

Item no.	Color	Price in €
53001000	Silver	3.40

Comprising 2 brackets.

End caps set

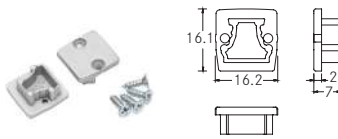

Item no.	Color	Price in €
53062260	Silver	2.90

Seal set for end caps

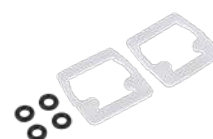

No IP protection

Item no.	Price in €
53009000	10.50



Surface-mounted corner profile P60-10

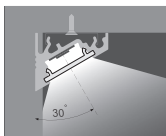
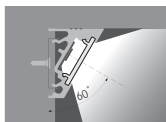
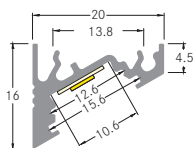

Advantages of surface-mounted corner profile:

- Compact surface-mounted corner profile.
- Alignment of the beam angle to 30° or 60 depending on the installation.
- Up to 4-meter length in one piece.
- Can be used for corner designs such as cabinet lighting or the kitchen countertop.

Finished length

Item no.	Lengths	Color	Price in €
53700260	2,000 mm	Aluminum anodized	28.10
53700070	2,000 mm	Painted in white	36.30

Assembly up to a maximum of 4,000 mm

Item no.	Assembly	Price in €
73700260	Aluminum profile 100 mm, anodized aluminum	2.00
73700070	Aluminum profile 100 mm, painted in white	2.60
73991000	Cut-out of the aluminum profile	5.80

In case of delivery lengths beyond 2,000 mm:
Please inquire for delivery costs separately.

Click cover: PMMA

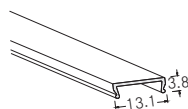

Finished length

Item no.	Lengths	Color	Price in €
53400000	2,000 mm	Transparent	15.40
53400070	2,000 mm	Opal	15.40

Assembly up to a maximum of 4,000 mm

Item no.	Assembly	Price in €
73400000	Cover 100 mm, transparent	1.10
73400070	Cover 100 mm, opal	1.10
73992000	Cut-out of cover	5.30

Bracket set

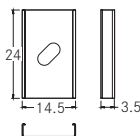

Item no.	Color	Price in €
53001000	Silver	3.40

Comprising 2 brackets.

Connecting piece 180°

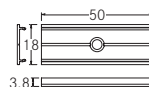

Item no.	Color	Price in €
53005000	Raw aluminum	3.50

Connecting piece 90°

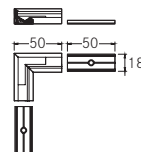

Item no.	Color	Price in €
53071260	Aluminum anodized	20.10
53071070	Painted in white	20.70

End caps set

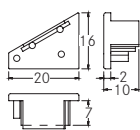

Item no.	Color	Price in €
53070260	Silver	2.90
53070070	White	2.90

Surface-mounted corner profile P61-10

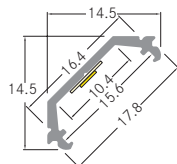

Advantages of surface-mounted corner profile:

- Simple surface-mounted corner profile.
- Semi-circular cover for full edge illumination.
- LED flex board is aligned to 45° angle.
- Up to 4-meter length in one piece.
- Compact accessory.

Finished length

Item no.	Lengths	Color	Price in €
53701260	2,000 mm	Aluminum anodized	22.10

Assembly up to a maximum of 4,000 mm

Item no.	Assembly	Price in €
73701260	Aluminum profile 100 mm, anodized aluminum	1.50
73991000	Cut-out of the aluminum profile	5.80

**In case of delivery lengths beyond 2,000 mm:
Please inquire for delivery costs separately.**

Click cover: PMMA

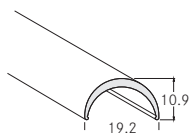

Finished length

Item no.	Lengths	Color	Price in €
53431070	2,000 mm	Opal	22.90

Assembly up to a maximum of 4,000 mm

Item no.	Assembly	Price in €
73431070	Cover 100 mm, opal	1.50
73992000	Cut-out of cover	5.30

Bracket set

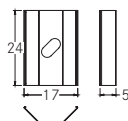

Item no.	Color	Price in €
53014000	Silver	3.80

Comprising 2 brackets.

End caps set

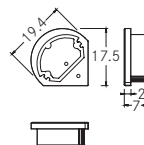

Item no.	Color	Price in €
53072260	Silver	4.00

Surface-mounted corner profile P62-14

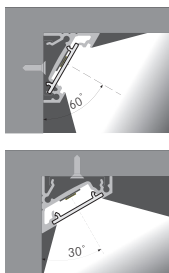
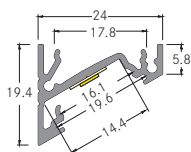

Advantages of surface-mounted corner profile:

- Wide surface-mounted corner profile.
- Available in white, black and aluminum colors.
- Up to 4-meter length in one piece.
- Soft light emission due to the higher cover.
- Concealed fastening directly on the base.
- Connecting piece 90° for rectangular application.

Finished length

Item no.	Lengths	Color	Price in €
53702260	2,000 mm	Aluminum anodized	33.50
53702070	2,000 mm	Painted in white	49.30
53702080	2,000 mm	Black anodized	49.30

Assembly up to a maximum of 4,000 mm

Item no.	Assembly	Price in €
73702260	Aluminum profile 100 mm, anodized aluminum	2.30
73702070	Aluminum profile 100 mm, painted in white	3.30
73702080	Aluminum profile 100 mm, black anod.	3.30
73991000	Cut-out of the aluminum profile	5.80

In case of delivery lengths beyond 2,000 mm: Please inquire for delivery costs separately.

Click cover: PMMA

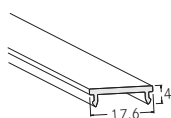

Finished length

Item no.	Lengths	Color	Price in €
53402000	2,000 mm	Transparent	18.70
53402070	2,000 mm	Opal	18.70
53402080	2,000 mm	Black	18.70

Assembly up to a maximum of 4,000 mm

Item no.	Assembly	Price in €
73402000	Cover 100 mm, transparent	1.30
73402070	Cover 100 mm, opal	1.30
73402080	Cover 100 mm, black	1.30
73992000	Cut-out of cover	5.30

Click cover: PMMA

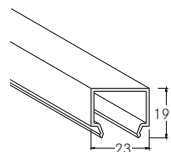

Finished length

Item no.	Lengths	Color	Price in €
53432070	2,000 mm	Opal	45.50

Assembly up to a maximum of 4,000 mm

Item no.	Assembly	Price in €
73432070	Cover 100 mm, opal	3.00
73992000	Cut-out of cover	5.30

Bracket set

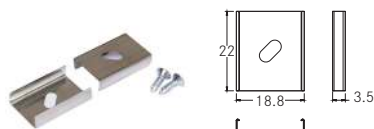

Item no.	Color	Price in €
53003000	Silver	4.30

Comprising 2 brackets.

Connecting piece 180°



Item no.	Color	Price in €
53004000	Raw aluminum	3.40

Connecting piece 90°

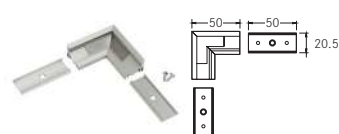

Item no.	Color	Price in €
53084260	Aluminum anodized	24.60
53084070	Painted in white	25.40
53084080	Black anodized	25.40

End caps set for 53402...

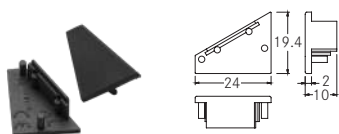

Item no.	Color	Price in €
53073260	Silver	3.00
53073070	White	3.00
53073080	Black	3.00

End caps set for 53432070

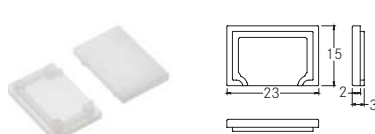

Item no.	Color	Price in €
53056070	Opal	4.40

Surface-mounted corner profile P63-14

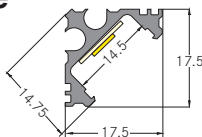

Advantages of surface-mounted corner profile:

- Technical surface-mounted corner profile
- Up to 6-meter length in one piece
- Covers on a roll, up to 80 meters in one piece.
- Good to use for cove lighting.

Finished length

Item no.	Lengths	Color	Price in €
53703260	2,000 mm	Aluminum anodized	31.20

Assembly up to a maximum of 6,000 mm

Item no.	Assembly	Price in €
73703260	Aluminum profile 100 mm, anodized aluminum	2.20
73991000	Cut-out of the aluminum profile	5.80

**In case of delivery lengths beyond 2,000 mm:
Please inquire for delivery costs separately.**

Flex-click cover: PC

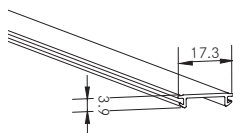

Up to 80 meters* in one roll



* On request

Finished length

Item no.	Lengths	Color	Price in €
53440000	2,000 mm	Transparent	30.70
53440070	2,000 mm	Opal	30.70
53440080	2,000 mm	Black	44.50

Assembly

Item no.	Assembly	Price in €
73440000	Cover 100 mm, transparent	2.10
73440070	Cover 100 mm, opal	2.10
73440080	Cover 100 mm, black	3.10
73992000	Cut-out of cover	5.30

Bracket set

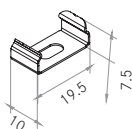

Item no.	Color	Price in €
53034000	Silver	6.20

Comprising 2 brackets.

End caps set

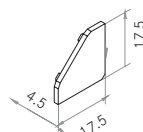
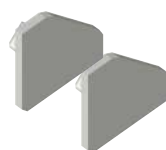

Item no.	Color	Price in €
53085260	Aluminum	24.50

BB surface-mounted corner profile

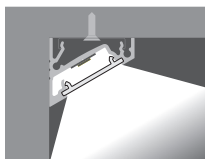
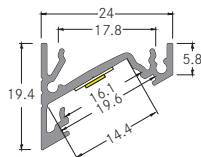

NEW

Advantages of surface-mounted corner profile:

- Simple surface-mounted corner profile.
- Profile and corresponding covers are available in lengths of 1 meter, 2 meters and 3 meters.
- Optimum heat dissipation for durable illumination.

Finished length

Item no.	Lengths	Color	Price in €
53385261	1,000 mm	Aluminum anodized	11.40
53385262	2,000 mm	Aluminum anodized	22.00
53385263	3,000 mm	Aluminum anodized	32.90

Flex-click cover: PC

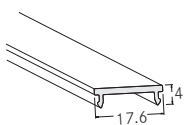

Finished length

Item no.	Lengths	Color	Price in €
53489001	1,000 mm	Transparent	4.30
53489071	1,000 mm	Opal	4.30
53489002	2,000 mm	Transparent	8.70
53489072	2,000 mm	Opal	8.70
53489003	3,000 mm	Transparent	13.80
53489073	3,000 mm	Opal	13.80

Bracket set

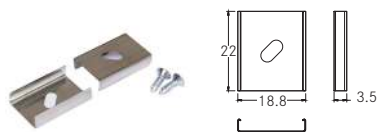

Item no.	Color	Price in €
53040000	Silver	2.20

Comprising 2 brackets.

End caps set

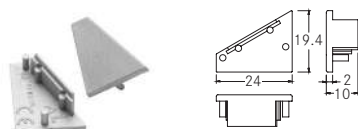

Item no.	Color	Price in €
53037260	Silver	1.60

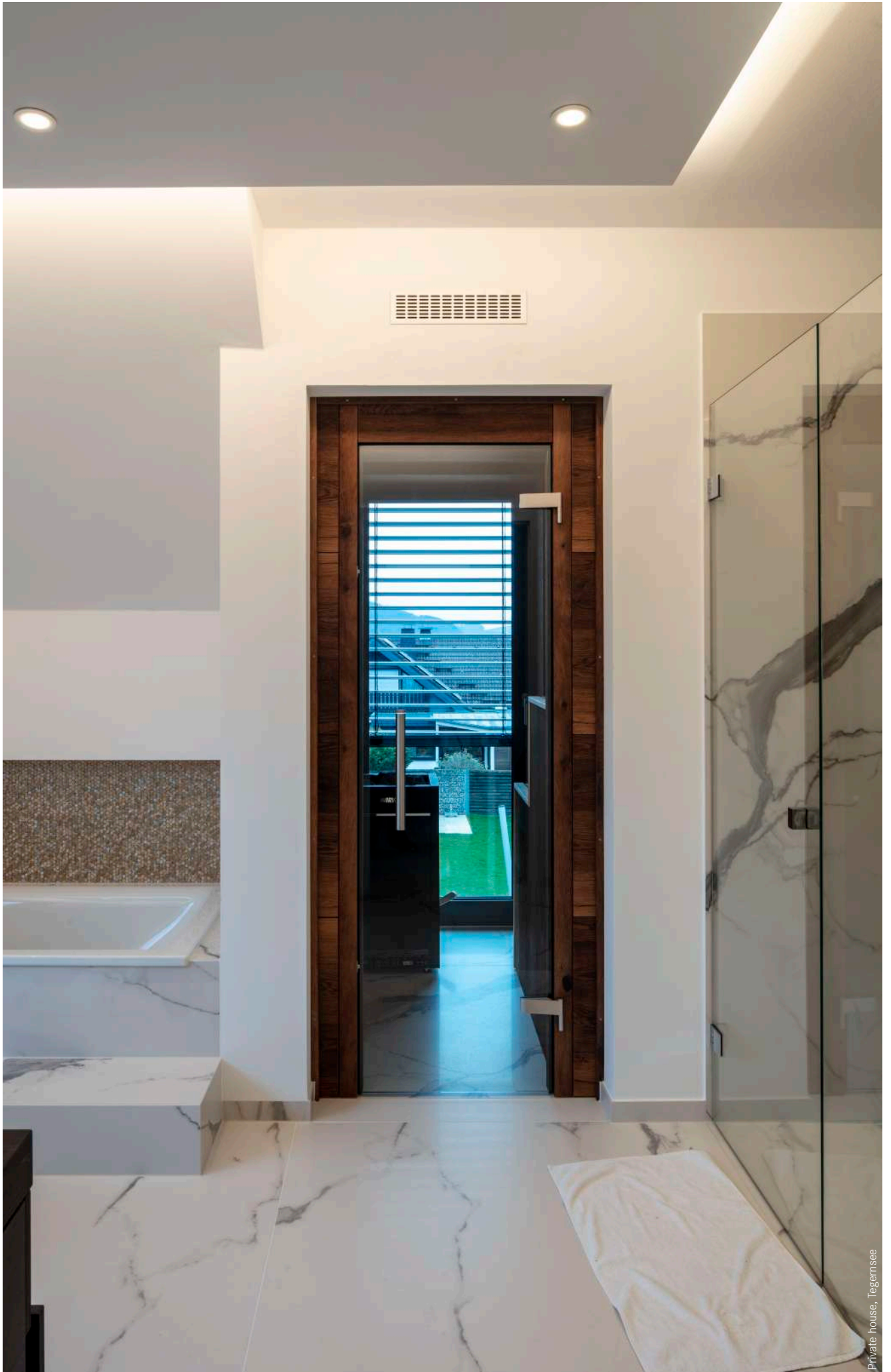

Private house, Tegernsee

Flexible profile P72-12

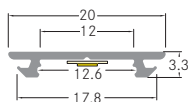

Advantages of the flexible profile:

- For the design of organic shapes.
- The cover and profile can be bent together, attention: keep the possible difference in length in mind.
- Semi-circular cover for a wide light emission.
- The profile can also be used as a pendant variant.
- High flexibility, horizontal minimum bending radius of 500 mm.

Finished length

Item no.	Lengths	Color	Price in €
53753260	2,000 mm	Aluminum anodized	19.40
53753070	2,000 mm	Painted in white	22.60

Assembly up to a maximum of 4,000 mm

Item no.	Assembly	Price in €
73753260	Aluminum profile 100 mm, anodized aluminum	1.40
73753070	Aluminum profile 100 mm, painted in white	1.60
73991000	Cut-out of the aluminum profile	5.80

In case of delivery lengths beyond 2,000 mm:
Please inquire for delivery costs separately.

Cover, flexible: PMMA

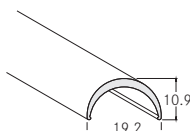

Finished length

Item no.	Lengths	Color	Price in €
53431070	2,000 mm	Opal	22.90

Assembly up to a maximum of 4,000 mm

Item no.	Assembly	Price in €
73431070	Cover 100 mm, opal	1.50
73992000	Cut-out of cover	5.30

Bracket set for horizontal installation

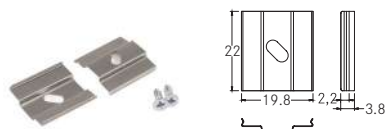

Item no.	Color	Price in €
53020000	Silver	4.30

Comprising 2 brackets.

Bracket set for vertical installation

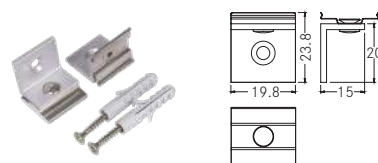

Item no.	Color	Price in €
53021000	Steel + Raw aluminum	11.40

Comprising 2 brackets.

End caps set



Item no.	Color	Price in €
53078260	Silver	3.10
53078070	White	3.10

Suspension set SELV 50V, 1,500 mm

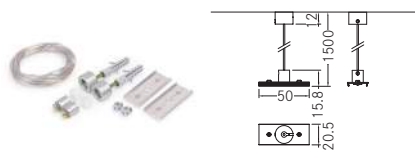

Item no.	Color	Price in €
53022260	Silver	65.80

Rope thickness: 0.5 mm, with coating: 1 mm, comprising 2 pieces



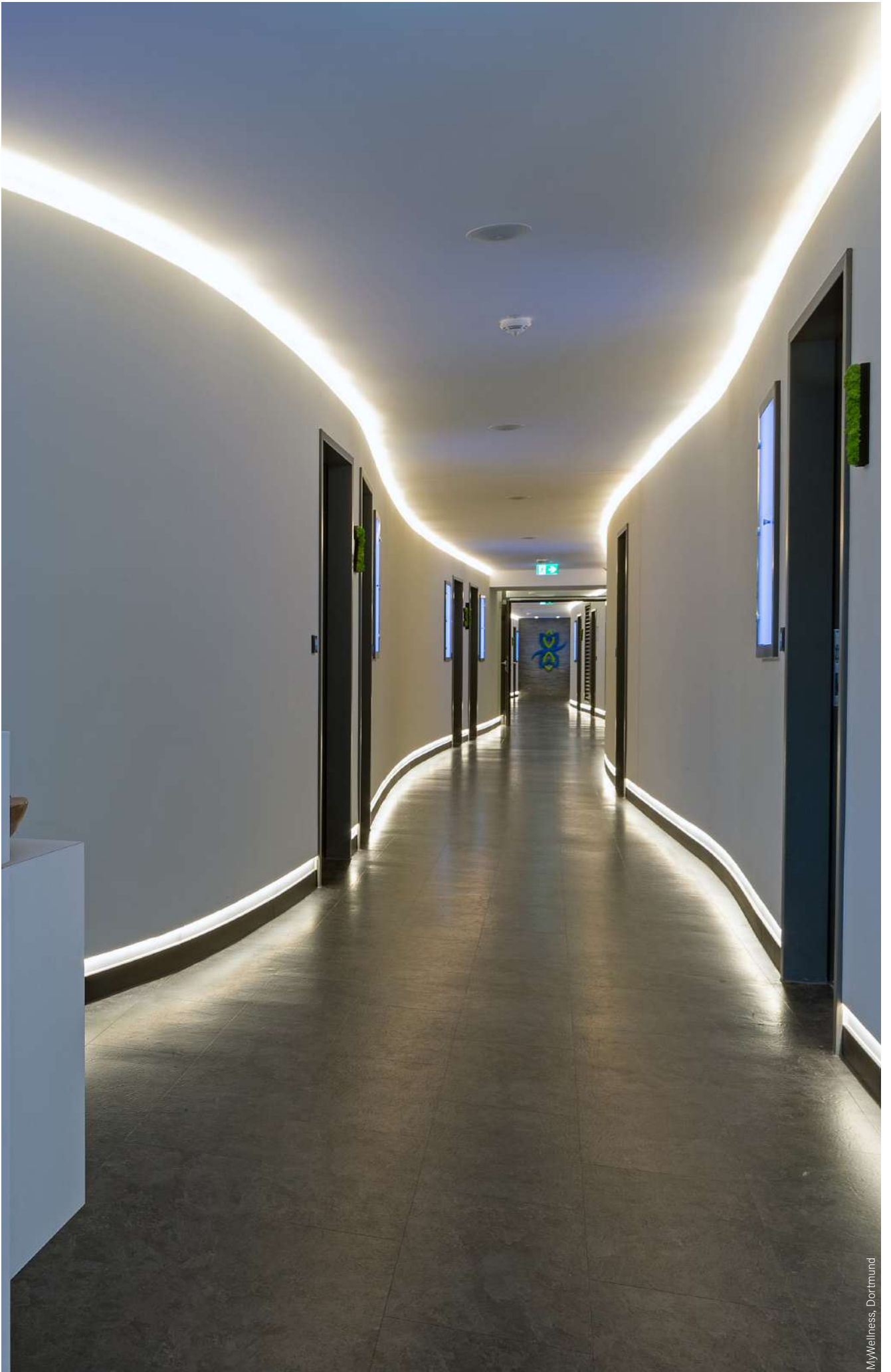

MyWellness, Dortmund



Borussia Mönchengladbach, BORUSSIA-PARK, Player's tunnel

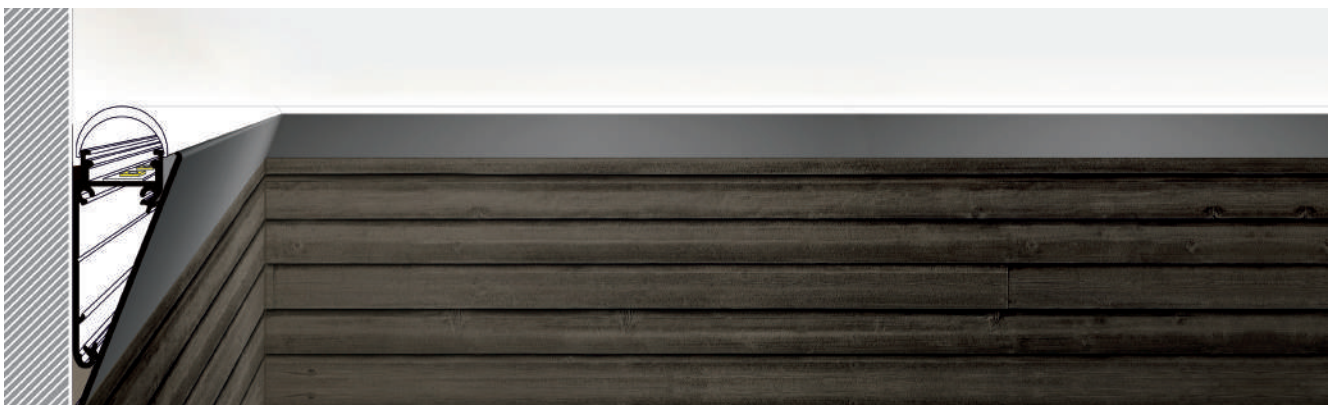

Wall surface-mounted profile P73-12

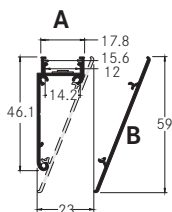

Advantages of wall surface-mounted profile:

- Uncomplicated implementation of wall surface-mounted solutions for indirect illumination.
- For a special lighting effect on the wall without a cove.
- Up to 4-meter length in one piece.
- Can be mounted downwards or upwards as required.
- Integrated cable guiding is possible.

Finished length

Item no.	Lengths	Color	Price in €
53754260	2,000 mm	Aluminum anodized	49.30
53754070	2,000 mm	Painted in white	59.70

Assembly up to a maximum of 4,000 mm

Item no.	Assembly	Price in €
73754260	Aluminum profile 100 mm, anodized aluminum	3.30
73754070	Aluminum profile 100 mm, painted in white	4.10
73991000	Cut-out of the aluminum profile	5.80

In case of delivery lengths beyond 2,000 mm:
Please inquire for delivery costs separately.

Click cover: PMMA

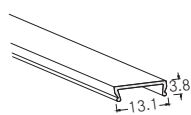

Finished length

Item no.	Lengths	Color	Price in €
53400000	2,000 mm	Transparent	15.40
53400070	2,000 mm	Opal	15.40

Assembly up to a maximum of 4,000 mm

Item no.	Assembly	Price in €
73400000	Cover 100 mm, transparent	1.10
73400070	Cover 100 mm, opal	1.10
73992000	Cut-out of cover	5.30

Click cover: PMMA

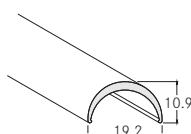

Finished length

Item no.	Lengths	Color	Price in €
53431070	2,000 mm	Opal	22.90

Assembly up to a maximum of 4,000 mm

Item no.	Assembly	Price in €
73431070	Cover 100 mm, opal	1.50
73992000	Cut-out of cover	5.30

Front aluminum cover plate



Finished length

Item no.	Length	Color	Price in €
53081260	2000 mm	Aluminum anodized	41.60
53081070	2000 mm	Painted in white	52.70

Assembly up to a maximum of 4,000 mm

Item no.	Price in €
73081260	Aluminum profile 100 mm, anodized aluminum 2.80
73081070	Aluminum profile 100 mm, painted in white 3.40
73991000	Cut-out of the aluminum profile 5.80

Connecting piece 90°

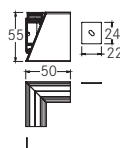

Item no.	Color	Price in €
53082260	Aluminum anodized	25.30
53082070	Painted in white	26.10

Connecting piece 180°

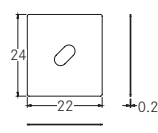

Item no.	Color	Price in €
53023000	Silver	4.10

End caps set for 53400...

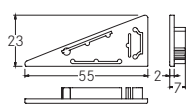

Item no.	Color	Price in €
53079260	Silver	4.00
53079070	White	4.00

End caps set for 53431070

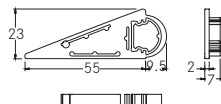

Item no.	Color	Price in €
53080260	Silver	4.00
53080070	White	4.00

Wall surface-mounted profile P74-14

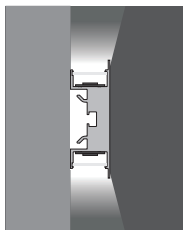
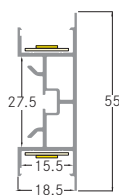

Advantages of wall surface-mounted profile:

- Uncomplicated implementation of wall surface-mounted solutions for indirect illumination.
- Double staging of the illumination, upwards and downwards, normal white light illumination and or RGB or TW illumination.
- Up to 6-meter length in one piece.
- High-quality accessories.

Finished length

Item no.	Lengths	Color	Price in €
53751260	2,000 mm	Aluminum anodized	71.90

Assembly up to a maximum of 6,000 mm

Item no.	Assembly	Price in €
73751260	Aluminum profile 100 mm, anodized aluminum	4.80
73991000	Cut-out of the aluminum profile	5.80

In case of delivery lengths beyond 2,000 mm:
Please inquire for delivery costs separately.

Flex-click cover: PC

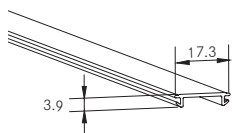

Up to 80 meters* in one roll



* On request

Finished length

Item no.	Lengths	Color	Price in €
53440000	2,000 mm	Transparent	30.70
53440070	2,000 mm	Opal	30.70
53440080	2,000 mm	Black	44.50

Assembly

Item no.	Assembly	Price in €
73440000	Cover 100 mm, transparent	2.10
73440070	Cover 100 mm, opal	2.10
73440080	Cover 100 mm, black	3.10
73992000	Cut-out of cover	5.30

Bracket set

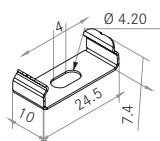

Item no.	Color	Price in €
53031000	Silver	7.20

Comprising 2 brackets.

Connecting piece 180°

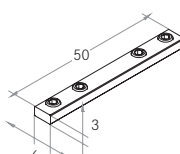

Item no.	Color	Price in €
53030000	Raw aluminum	14.90

End caps set

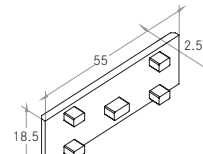

Item no.	Color	Price in €
53075260	Aluminum	33.40

Sight connector

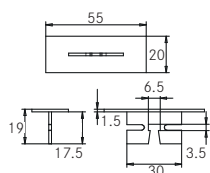

Item no.	Color	Price in €
53093260	Silver	36.00

Connector 53030000 is required for mounting.

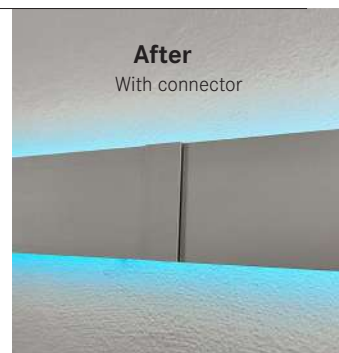
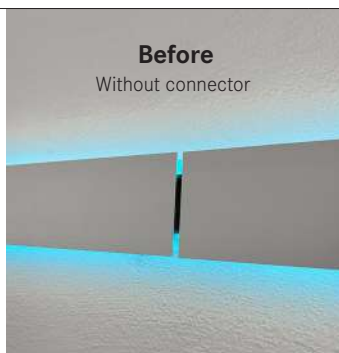

Recessed ceiling profile with wall mounting P75-14

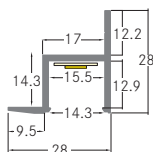

Advantages of recessed ceiling profile:

- Ideal for seamless installation in mineral fiber ceilings and Odenwald ceilings.
- Up to 6-meter length in one piece.
- Covers on a roll, up to 80 m in one piece.
- Wand mounting and ceiling bracket combined in one.

Finished length

Item no.	Lengths	Color	Price in €
53755260	2,000 mm	Aluminum anodized	35.80

Assembly up to a maximum of 6,000 mm

Item no.	Assembly	Price in €
73755260	Aluminum profile 100 mm, anodized aluminum	2.50
73991000	Cut-out of the aluminum profile	5.80

In case of delivery lengths beyond 2,000 mm:
Please inquire for delivery costs separately.

Flex-click cover: PC

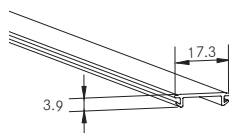

Up to 80 meters* in one roll



* On request

Finished length

Item no.	Lengths	Color	Price in €
53440000	2,000 mm	Transparent	30.70
53440070	2,000 mm	Opal	30.70
53440080	2,000 mm	Black	44.50

Assembly

Item no.	Assembly	Price in €
73440000	Cover 100 mm, transparent	2.10
73440070	Cover 100 mm, opal	2.10
73440080	Cover 100 mm, black	3.10
73992000	Cut-out of cover	5.30



Chancellery, Überlingen

Flat profile P76-16

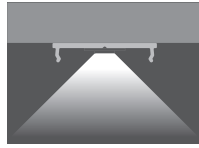
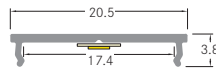

Advantages of flat profile:

- Compact and flat profile.
- Simple solution for cooling the LED flex board.
- Up to 4-meter length in one piece.
- Easiest installation for a light line.
- For application without cover.

Finished length

Item no.	Lengths	Color	Price in €
53756260	2,000 mm	Aluminum anodized	17.20
53756070	2,000 mm	Painted in white	22.90
53756080	2,000 mm	Black anodized	22.90

Assembly up to a maximum of 4,000 mm

Item no.	Assembly	Price in €
73756260	Aluminum profile 100 mm, anodized aluminum	1.30
73756070	Aluminum profile 100 mm, painted in white	1.60
73756080	Aluminum profile 100 mm, black anod.	1.60
73991000	Cut-out of the aluminum profile	5.80

In case of delivery lengths beyond 2,000 mm: Please inquire for delivery costs separately.



Bethoven School, Singen

Surface-mounted round profile P90-16

NEW

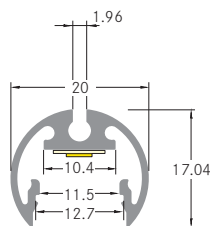

Advantages of surface-mounted round profile:

- Surface-mounted round profile for targeted alignment as per the lighting concept.
- Adjustable by rotating the profile.
- Suitable for installation on shelves.
- Light emission on the surface and/or the wall.
- Up to 4-meter length in one piece.

Finished length

Item no.	Lengths	Color	Price in €
53760260	2,000 mm	Aluminum anodized	39.00

Assembly up to a maximum of 4,000 mm

Item no.	Assembly	Price in €
73760260	Aluminum profile 100 mm, anodized aluminum	2.50
73991000	Cut-out of the aluminum profile	5.80

**In case of delivery lengths beyond 2,000 mm:
Please inquire for delivery costs separately.**

Click cover: PMMA

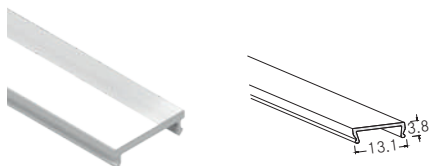

Finished length

Item no.	Lengths	Color	Price in €
53400000	2,000 mm	Transparent	15.40
53400070	2,000 mm	Opal	15.40

Assembly up to a maximum of 4,000 mm

Item no.	Assembly	Price in €
73400000	Cover 100 mm, transparent	1.10
73400070	Cover 100 mm, opal	1.10
73992000	Cut-out of cover	5.30

Bracket set



Item no.	Color	Price in €
53095260	Aluminum	11.50

Comprising 2 brackets.

End caps set



Item no.	Color	Price in €
53090260	Silver	1.80

Complete profile set

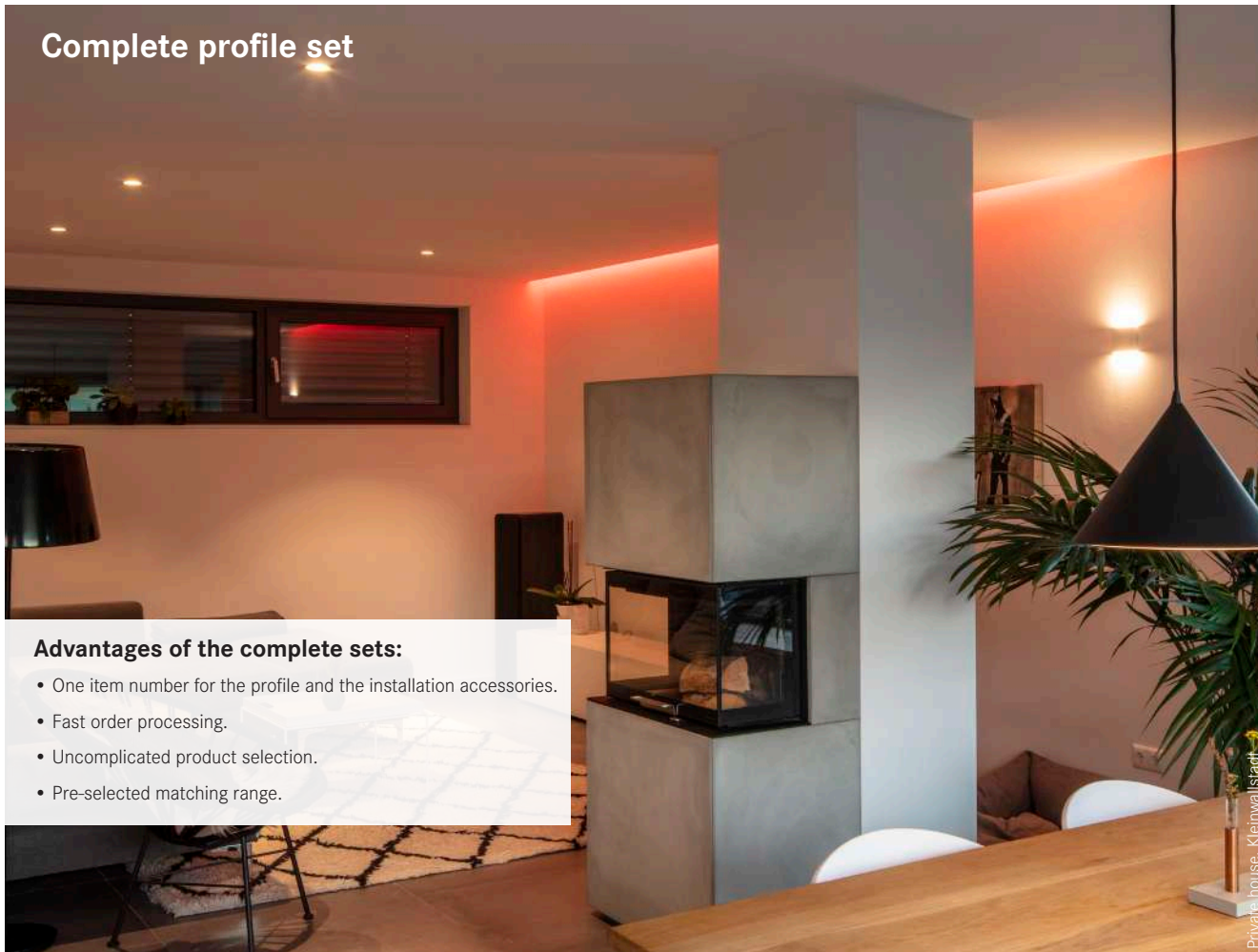

Advantages of the complete sets:

- One item number for the profile and the installation accessories.
- Fast order processing.
- Uncomplicated product selection.
- Pre-selected matching range.

Complete set of surface-mounted profile

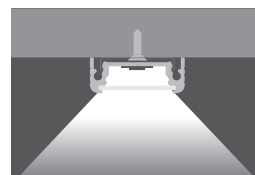
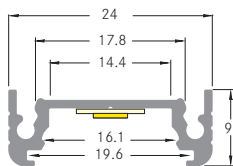

Complete set of aluminum profile

Item no.	Lengths	Color	Price in €
53901260	1,000 mm	Aluminum anodized	29.40
53901070	1,000 mm	Painted in white	35.80
53901080	1,000 mm	Black anodized	35.80
53902260	2,000 mm	Aluminum anodized	49.00
53902070	2,000 mm	Painted in white	61.70
53902080	2,000 mm	Black anodized	61.70

Scope of delivery

- 1 x aluminum profile
- 2 x end caps
- 2 x brackets for 1,000 mm
- 4 x brackets for 2,000 mm
- 1 x opal cover



Complete set of surface-mounted profile

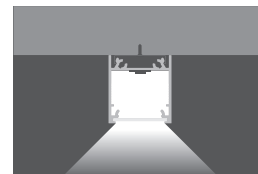
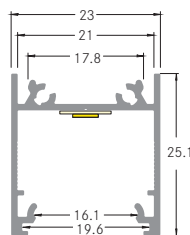

Complete set of aluminum profile

Item no.	Lengths	Color	Price in €
53921260	1,000 mm	Aluminum anodized	37.00
53921070	1,000 mm	Painted in white	42.30
53921080	1,000 mm	Black anodized	42.30
53922260	2,000 mm	Aluminum anodized	62.50
53922070	2,000 mm	Painted in white	73.10
53922080	2,000 mm	Black anodized	73.10

Scope of delivery

- 1 x aluminum profile
- 2 x end caps
- 2 x brackets for 1,000 mm
- 4 x brackets for 2,000 mm
- 1 x screw set
- 1 x opal cover



Complete set of surface-mounted corner profile

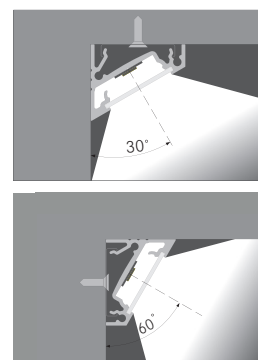
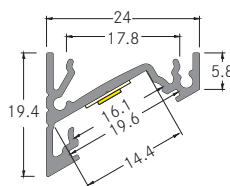

Complete set of aluminum profile

Item no.	Lengths	Color	Price in €
53911260	1,000 mm	Aluminum anodized	32.40
53911070	1,000 mm	Painted in white	41.00
53911080	1,000 mm	Black anodized	41.00
53912260	2,000 mm	Aluminum anodized	55.20
53912070	2,000 mm	Painted in white	72.20
53912080	2,000 mm	Black anodized	72.20

Scope of delivery

- 1 x aluminum profile
- 2 x end caps
- 2 x brackets for 1,000 mm
- 4 x brackets for 2,000 mm
- 1 x opal cover



Feeds / connectors / direct connectors for white light



Feed for 15201.../15202...



Item no.	Number of poles	Price in €
15717000	2	2.50

Feed must be used only for 15201.../15202...; maximum 3A, including approximately 150-mm connection cable.

Connector for 15201.../15202...

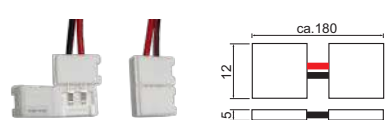

Item no.	Number of poles	Price in €
15718000	2	4.00

Connecting element must be used only for 15201.../15202...; maximum 3A, including approximately 150-mm connection cable.

Direct connector for 15201.../15202...



Item no.	Number of poles	Price in €
15719000	2	2.30

Director connector must be used only for 15201.../15202...; maximum 3A.

Feed for 15203...



Item no.	Number of poles	Price in €
15725000	2	3.10

Feed must be used only for 15203...; maximum 3A, including approximately 150-mm connection cable.

Connector for 15203...

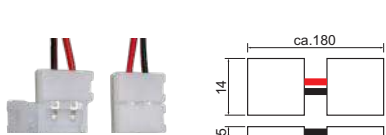

Item no.	Number of poles	Price in €
15728000	2	4.40

Connecting element must be used only for 15203...; maximum 3A, including approximately 150-mm connection cable.

Direct connector for 15203...



Item no.	Number of poles	Price in €
15731000	2	2.70

Director connector must be used only for 15203...; maximum 3A.

Feeds / connectors / direct connectors for RGB

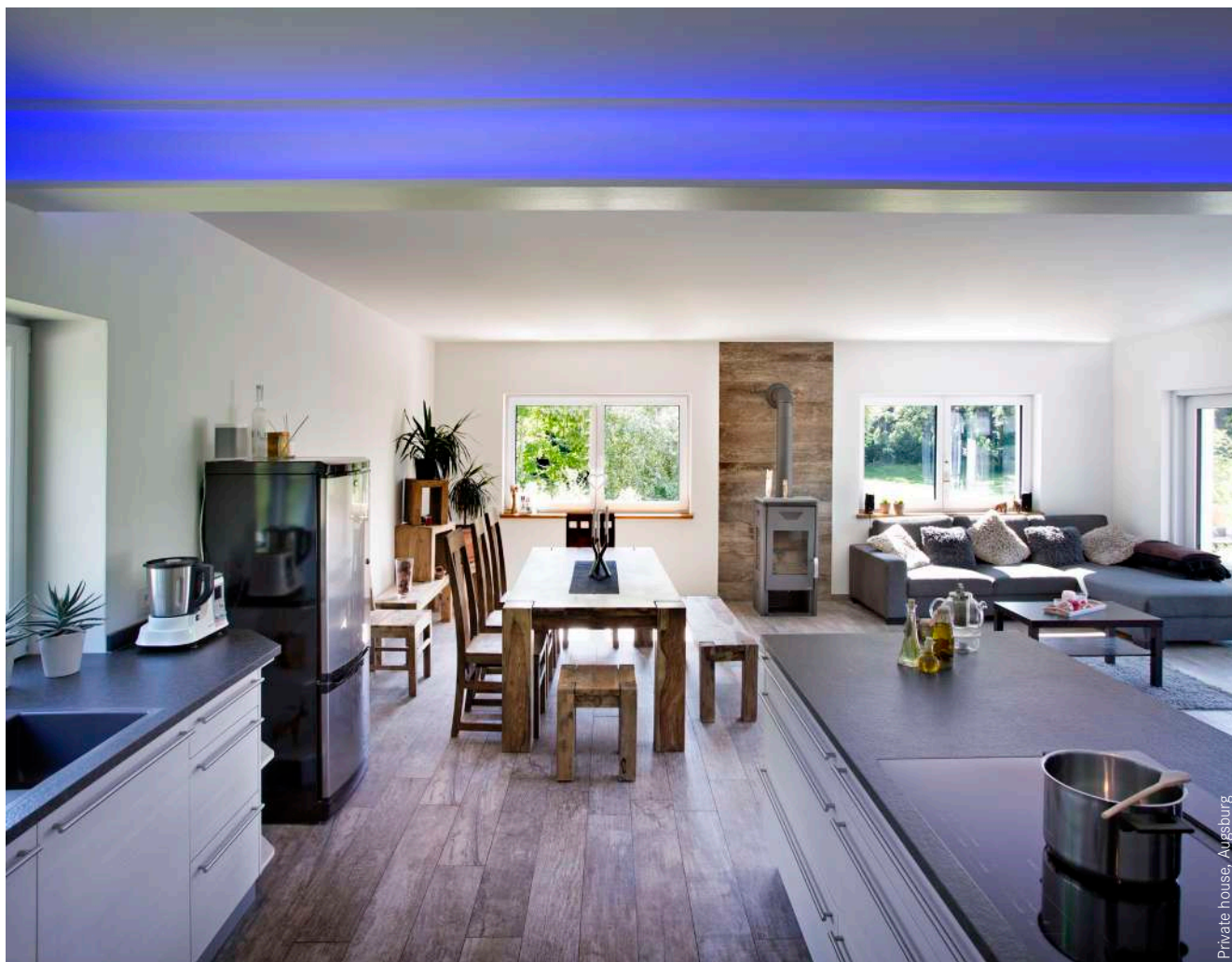

Private house, Augsburg

Feed for 15203001

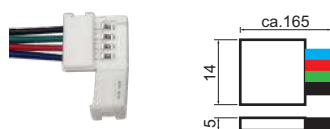

Item no.	Number of poles	Price in €
15726000	4 (RGB)	3.60

Feed must be used only for 15203001, maximum 3A, including approximately 150-mm connection cable.

Connector for 15203001

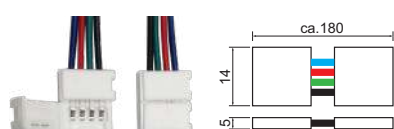

Item no.	Number of poles	Price in €
15729000	4 (RGB)	4.80

Connecting element must be used only for 15203001, maximum 3A, including approximately 150-mm connection cable.

Direct connector for 15203001

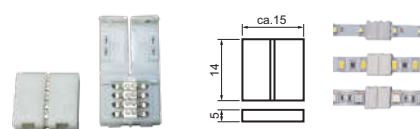

Item no.	Number of poles	Price in €
15732000	4 (RGB)	3.00

Director connector must be used only for the flexible LED RGB printed circuit board 15203001; maximum 3A.

Silicon end cap set, 12 mm



Item no.	Price in €
15720000	11.00

12x silicon end caps for flexible printed circuit boards IP67, including a silicon tube (3g) for sealing. Suitable for printed circuit boards 15271... and 15272..., width 12 mm.

Silicon end cap set, 14 mm



Item no.	Price in €
15721000	11.00

12x silicon end caps for flexible printed circuit boards IP67, including a silicon tube (3g) for sealing. Suitable for printed circuit board 15273... (not suitable for RGB), width 14 mm

Service for assembly

Special assembly of LED flex boards, aluminum profiles and plastic covers



Special assembly of LED flex boards

We have divided the complete roll length of our QualityFlex flex boards into the smallest divisible length unit. For the length you need, please order a multiple of this minimum unit.

Important:

Each special length must be ordered as a single item.

The maximum permissible special length (item no.: 75...) =

Total length of the corresponding roll product (item no.: 15...).

Cut-out variants:

75998000 = assembly of the connection cable with protection class IP00

75999000 = assembly of the connection cable with enhanced protection class IP60, IP65 and IP67.

Order example for QualityFlex flex boards with IP00:

Roll product item no. 15201027

(IP00, total length 5,000 mm);

Smallest divisible unit = 100 mm = item no. 75201027

You need a length of 3,600 mm of these QualityFlex flex boards.

The order is:

36 x item 75201027 = QualityFlex flex boards, length 3,600 mm

1 x item no. 75998000 = assembly with protection class IP00,
Including connection cable on one side (soldered, length 300 mm)



Order example for QualityFlex flex boards with IP60 or IP67:

Roll product item no. 15223003 (IP60, total length 5,000 mm);

Smallest divisible unit = 100 mm = item no. 75223003

You need a length of 2,100 mm of these QualityFlex flex boards.

The order is:

21 x item no. 75223003 = QualityFlex flex boards, length 2,100 mm

1 x item no. 75999000 = assembly with enhanced protection class,
Including connection cable on one side (soldered, length 300 mm).



Special assembly of aluminum profiles and plastic covers

We offer our QualityFlex aluminum profiles and the corresponding plastic covers in the standard length of 2,000 mm. For special lengths, please always order a multiple of the minimum unit of 100 mm.

Important:

Each profile must be ordered as a single item.
Please inquire separately for special lengths greater than 2,000 mm.

Cut-out variants:

73991000 = cut-out of aluminum profiles

73992000 = cut-out of plastic covers



Order example for QualityFlex aluminum profiles

You need a special length of 700 mm of the aluminum profile (item no. 53654260) as well as the corresponding plastic cover (item no. 53402070).

The order is:

7 x item no. 73654260 = aluminum profile, length 700 mm

1 x item no. 73991000 = cut-out of aluminum profiles

Order example for QualityFlex plastic covers

The order is:

7 x item no. 73402070 = plastic cover, length 700 mm

1 x item no. 73992000 = cut-out of plastic covers

Our sales staff will be happy to answer any questions you may have.

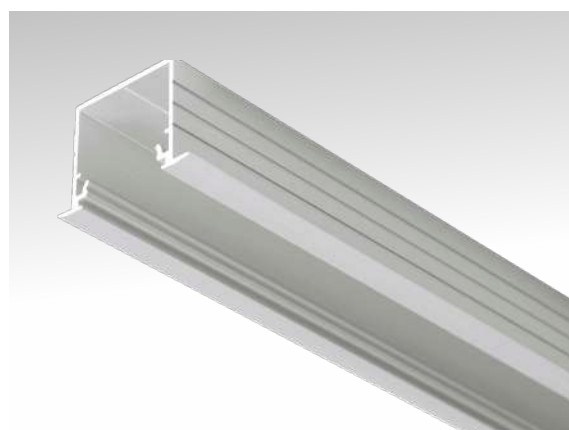

1

Interior lighting



08

Table lamps, floor lamps and floor luminaires.

Decorative lamp classics and standard-compliant workplace lighting.

Table shade luminaires

Page 410

Office floor luminaires

Page 414

Floor shade luminaires

Page 413

Ground recessed luminaires

Page 416





Table lamp, with fabric shade

Table lamp with fabric shade, head swivels 180°, Shade material: Chintz, shade color: brown, surface: nickel matte, height: 450 mm, approximately 1,250 mm visible, black feed line with intermediate cord switch and Euro flat plug. Other shade variants can be made available on request.

Model: G9, power: 1 x maximum 48 W

You can find deliverable shade colors and special solutions for each product online in the PDF format on our website.

Item no.	Color	Price €
58126150	Nickel matte / brown shade	499.90



This item is subject to discount group 2. For suitable floor lamp, see page 413 and for suitable wall-mounted luminaires, see page 235.



Table lamp, with fabric shade

Table lamp with fabric shade, head swivels 180°, Shade material: Chintz, shade color: black, surface: black powdered. Height: 450 mm, approximately 1,250 mm visible, black feed line with intermediate cord switch and Euro flat plug. Other shade variants can be made available on request.

Model: G9, power: 1 x maximum 48 W

You can find deliverable shade colors and special solutions for each product online in the PDF format on our website.

Item no.	Color	Price €
58146080	Black/black shade	419.90



This item is subject to discount group 2. For suitable floor lamp, see page 413 and for suitable wall-mounted luminaires, see page 233.



Table lamp, with fabric shade

Table lamp with fabric shade, Shade material: Chintz; shade color: black, surface: chromium Diameter: 300 mm, height: 530 mm, approximately 1,000 mm visible, black feed line with intermediate cord switch and Euro flat plug. Other shade variants can be made available on request.

Model: E27, power: 1 x maximum 60 W

You can find deliverable shade colors and special solutions for each product online in the PDF format on our website.

Item no.	Color	Price €
58106020	Chromium/black shade	319.90



This item is subject to discount group 2. For suitable floor lamp, see page 413 and for suitable wall-mounted luminaires, see page 234.



Table lamp, with fabric shade

Table lamp with fabric shade, Shade material: Chintz; shade color: black, surface: chromium Diameter: 250 mm, height: 470 mm, approximately 1,000 mm visible, black feed line with intermediate cord switch and Euro flat plug. Other shade variants can be made available on request.

Model: E27, power: 1 x maximum 60 W

You can find deliverable shade colors and special solutions for each product online in the PDF format on our website.

Item no.	Color	Price €
58107020	Chromium/black shade	299.90



This item is subject to discount group 2. For suitable floor lamp, see page 413 and for suitable wall-mounted luminaires, see page 234.



Table lamp, with fabric shade

Table lamp with fabric shade,
Shade material: Chintz, shade color: raw white, surface: nickel matte,
diameter: 200 mm, height: 520 mm, approximately 1,000 mm visible,
black feed line with intermediate cord switch and Euro flat plug.
Other shade variants can be made available on request.

Model: E27, power: 1 x maximum 60 W

You can find deliverable shade colors and special solutions for each product online in the PDF format on our website.

Item no.	Color	Price €
58166150	Nickel matte / raw white shade	249.90



This item is subject to discount group 2.
For suitable floor lamp, see page 413
and for suitable wall-mounted luminaires, see page 232.



Table lamp, with fabric shade

Table lamp with fabric shade,
Shade material: Chintz, shade color: raw white, surface: nickel matte,
diameter: 170 mm, height: 420 mm, approximately 1,000 mm visible,
black feed line with intermediate cord switch and Euro flat plug.
Other shade variants can be made available on request.

Model: E27, power: 1 x maximum 60 W

You can find deliverable shade colors and special solutions for each product online in the PDF format on our website.

Item no.	Color	Price €
58167150	Nickel matte / raw white shade	229.90



This item is subject to discount group 2.
For suitable floor lamp, see page 413
and for suitable wall-mounted luminaires, see page 232.

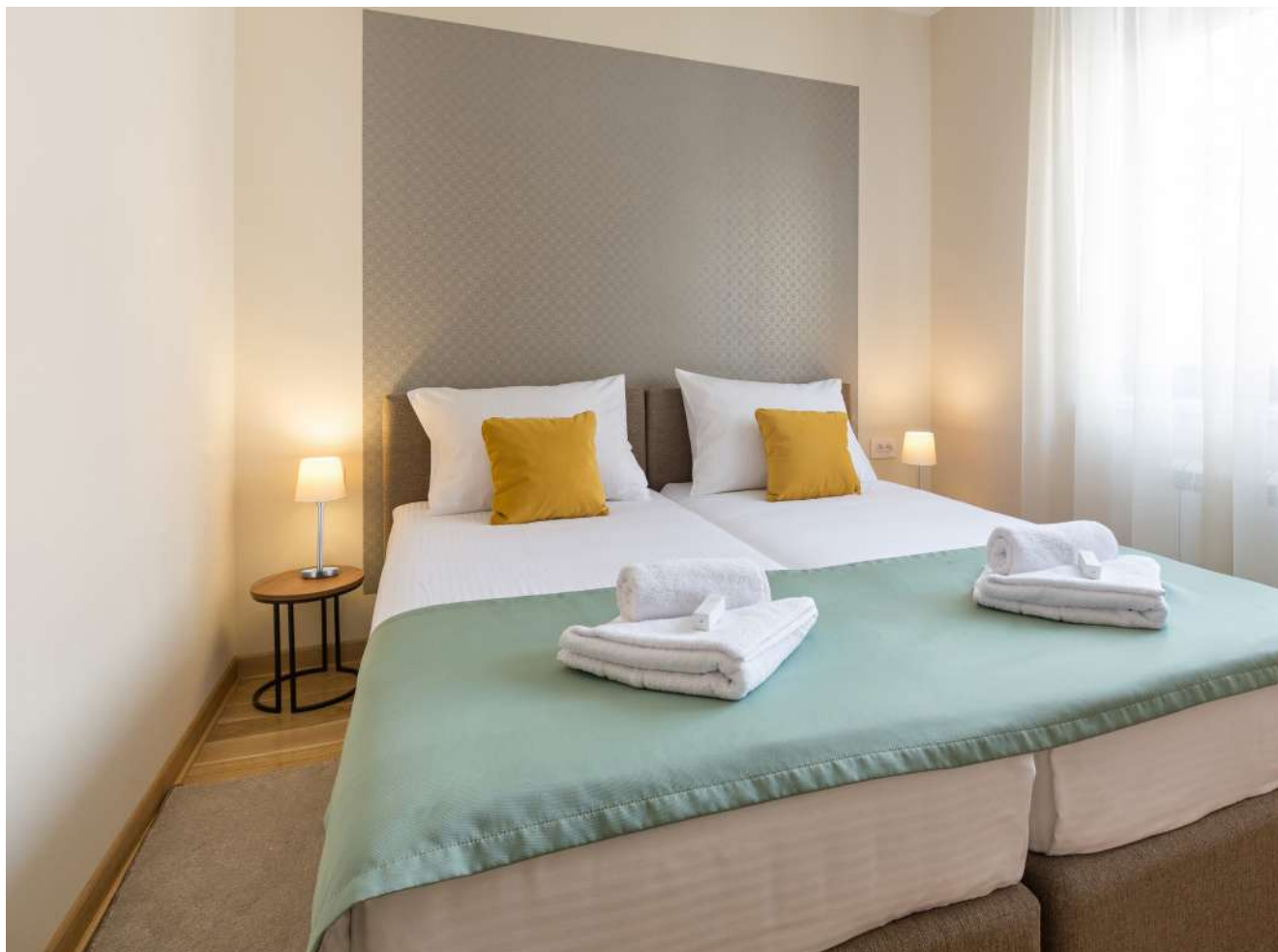





Floor lamp, with fabric shade

Floor lamps with fabric shade, head swivels 180°,
Shade material: Chintz, shade color: brown, surface: nickel matte,
approximately 1,700 mm visible, black feed line with cord wiper switch
and Euro flat plug.

Other shade variants can be made available on request.

Model: G9, power: 1 x maximum 48 W,
dimensions: H 1,150 x D 430 mm

You can find deliverable shade colors and special solutions for each
product online in the PDF format on our website.

Item no.	Color	Price €
58120150	Nickel matte / brown shade	599.90



This item is subject to discount group 2.
For suitable table lamps, see page 410
and for suitable wall-mounted luminaires, see page 235.



Floor lamp, with fabric shade

Floor lamps with fabric shade, head swivels 180°,
Shade material: Chintz, shade color: black, surface: black powdered,
approximately 1,700 mm visible, black feed line with cord wiper switch
and Euro flat plug.

Other shade variants can be made available on request.

Model: G9, power: 1 x maximum 48 W,
dimensions: H 1,150 x D 390 mm

You can find deliverable shade colors and special solutions for each
product online in the PDF format on our website.

Item no.	Color	Price €
58140080	Black/black shade	499.90



This item is subject to discount group 2.
For suitable table lamps, see page 410
and for suitable wall-mounted luminaires, see page 233.



Floor lamp, with fabric shade

Floor lamps with fabric shade,
Shade material: Chintz; shade color: black, surface: chromium, approx-
imately 1,350 mm visible, black feed line with cord wiper switch and
Schuko plug.

Other shade variants can be made available on request.

Model: E27, power: 1 x maximum 100 W,
dimensions: H 1,630 x D 400 mm

You can find deliverable shade colors and special solutions for each
product online in the PDF format on our website.

Item no.	Color	Price €
58100020	Chromium/black shade	459.90



This item is subject to discount group 2.
For suitable table lamps, see page 410
and for suitable wall-mounted luminaires, see page 234.



Floor lamp, with fabric shade

Floor lamps with fabric shade,
Shade material: Chintz, shade color: raw white, surface: nickel matte,
approximately 1,500 mm visible, black feed line with cord wiper switch
and Schuko plug.

Other shade variants can be made available on request.

Model: E27, power: 1 x maximum 100 W,
dimensions: H 1,650 x D 450 mm

You can find deliverable shade colors and special solutions for each
product online in the PDF format on our website.

Item no.	Color	Price €
58160150	Nickel matte / raw white shade	519.90



This item is subject to discount group 2.
For suitable table lamps, see page 411
and for suitable wall-mounted luminaires, see page 232.

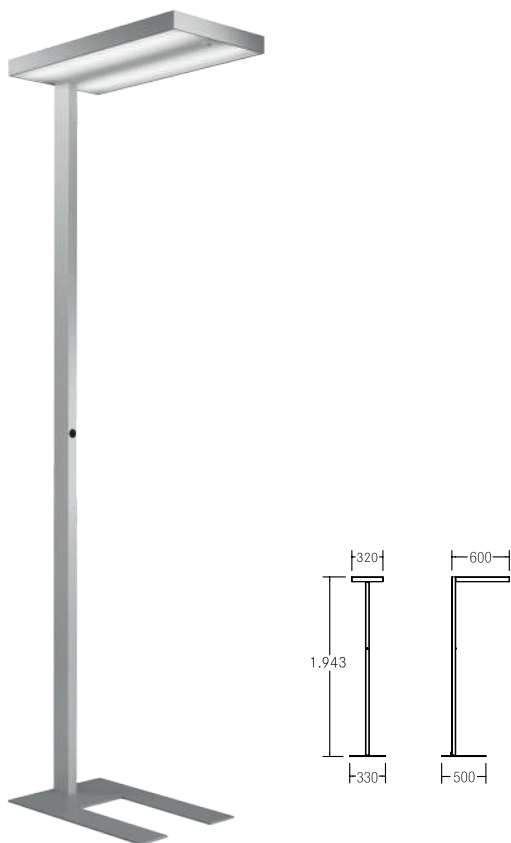

BIRO LED floor lamps, microprismatic cover, with indirect component

Illuminants: LED, power: 82 W, color temperature: 4000 K, luminous flux: 9,100 lm (direct: 2,950 lm / indirect: 6,150 lm), beam angle: 80°, color rendering: CRI > 80, UGR < 19, material: Aluminum / Steel / Plastic, color: silver, visual effect: Microprisms (direct) / transparent (indirect), delivery: including 2,500-mm feed line with Schuko angle plug

Luminous flux maintenance: L80/B20, 50,000 hours (ta: +25 °C)



Item no.	Description	Price €
77401694	Control: Daylight / presence sensor, dimming via integrated pushbutton	1,199.00
77402694	Control unit: switchable (not dimmable)	949.00

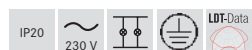

These items are subject to discount group 2. Additional floor luminaire variants are available on request.





LED ground recessed luminaires, IP44

Extremely flat ground recessed luminaires for indoor areas. The connection cable (item no. 3714) and the connection line (item no. 3715) must be ordered separately!

Illuminants: LED, model: Plug&Play, power: 0.4 W, material: Stainless steel / Acrylic

LED ground recessed luminaires, IP44

Extremely flat ground recessed luminaires for indoor areas. The connection cable (item no. 3714) and the connection line (item no. 3715) must be ordered separately!

Illuminants: LED, model: Plug&Play, power: 0.4 W, material: Stainless steel / Acrylic

Item no.	Color	Color temperature	Price €
3900WW	Stainless steel	3000 K	79.00
3900W	Stainless steel	5000 K	79.00

Item no.	Color	Color temperature	Price €
3901WW	Stainless steel	3000 K	79.00
3901W	Stainless steel	5000 K	79.00

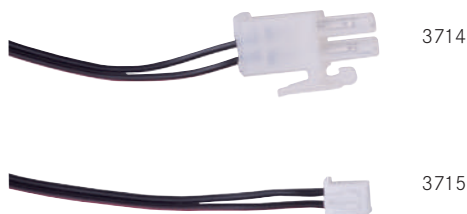
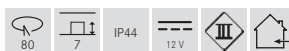
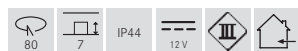

LED power supply 12 V DC, switchable

Cable length: primary side: 90 mm, secondary side: 80 mm, AMP coupling, primary side: 230 V AC, secondary side: 12 V DC, dimensions: D 57.5 mm, H 19 mm

Frequency: 50 Hz, dimming type: switchable, ambient temperature (ta): 0 °C to +40 °C, measuring point (tc): maximum +70 °C, material: Plastic

LED connection / connecting cable for 3900.. 3901.

3714: Connection cable 2 x 0.34 mm², black, length: 5,000 mm, for connecting the power supply unit (secondary) to the first luminaire with JST coupling for luminaire connection and AMP plug for power supply unit connection.

3715: Connection cable 2 x 0.34 mm², black, length 2,000 mm, for connection from one luminaire to the other.

Item no.	Secondary voltage	Power	Price €
3559	12 V	0.1–10 W	76.40

Item no.	Description	Price €
3714	Connection cable (connection of the first luminaire)	9.90
3715	Connection cable (connection from one luminaire to the other)	9.90



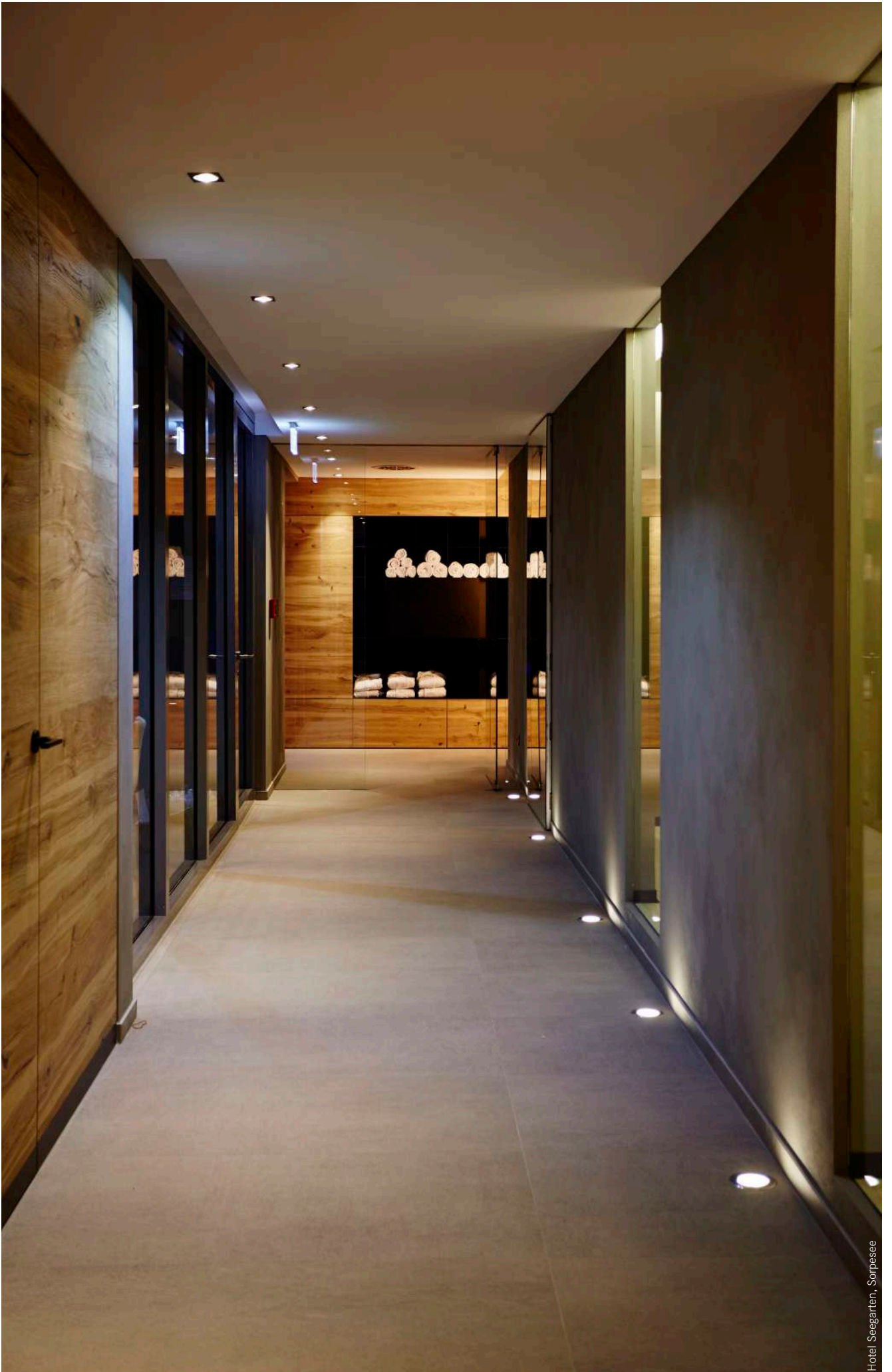

Hotel Seegarten, Sarpesee

1

Interior lighting

09

Moisture-proof luminaires.

Large areas are illuminated efficiently and safely.

HUMID ONE moisture-proof tub luminaires

Page 420

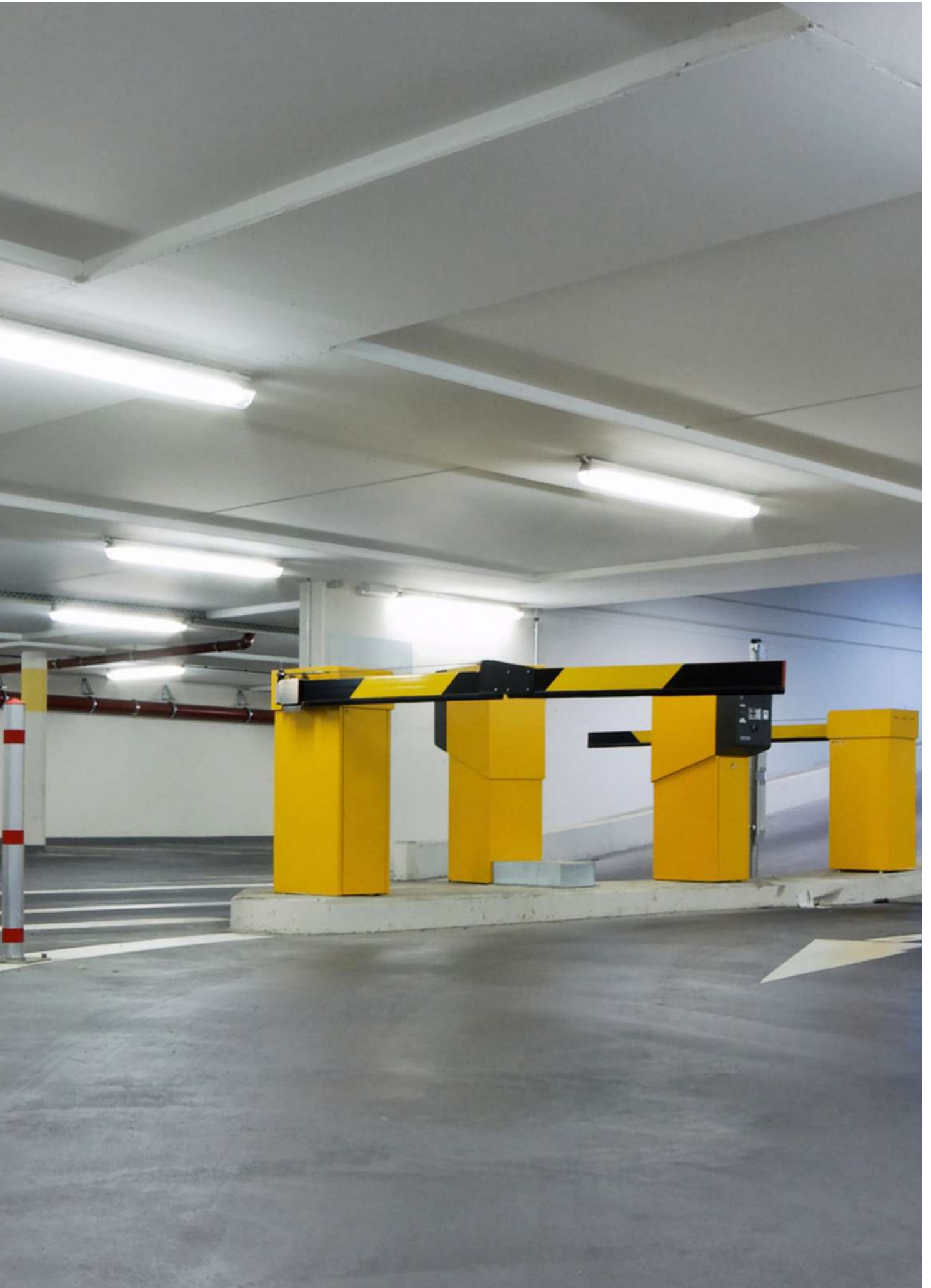

HUMID ONE moisture-proof luminaires.

Durable, resistance-proof luminaires for special areas.

Key features of the products:

- 5-year warranty.
- Long service life: L80B50 > 50,000 h at +25 °C.
- High efficiency: up to 135 lm/Watt.
- Planning reliability due to enclosed accessories.
- Fast installation: Through-wiring via cable sets 600/1,200/1,500 mm possible.

IP65 has complete protection against contact. Dust cannot enter and it is protected against water jets from any direction.

Exceptionally efficient for storage rooms, basements, garages or parking garages: Moisture-proof luminaires with LED illuminants. These not only provide the necessary brightness, but are also very durable with up to 50,000 hours of burning life. By means of the enclosed accessories, they are suitable not only as ceiling surface-mounted, but also as pendant or wall-mounted luminaires. The housing can remain at its installation position when the illuminant needs to be replaced. Thanks to the replaceable LED modules and drivers, the luminaires are ready for use again in just a few steps. Their PC-plastic-cover also makes them particularly robust and durable. As a result, Brumberg moisture-proof luminaires can be used in a temperature range between -20 degrees Celsius and +40 degrees Celsius. With their output of 18 to 51 watts, a color temperature of 4000 Kelvin and a color rendering index of CRI > 80, they safely and reliably illuminate areas with little or no daylight.

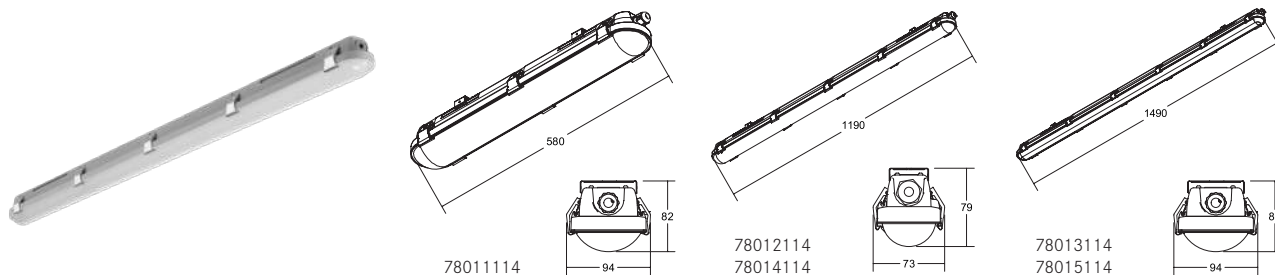

HUMID ONE LED moisture-proof tub luminaire

NEW

Illuminants: LED, color rendering: CRI > 80, beam angle: 120°, material: Polycarbonate / Stainless steel, delivery: including converter for connection with 230 V mains voltage, switchable

Item no.		Luminous flux	Power	Color temperatur	Length	Width	Price €
78011114	NEW	2,300 lm	18 W	4000 K	580 mm	94 mm	50.40
78012114	NEW	2,300 lm	18 W	4000 K	1,190 mm	73 mm	67.40
78013114	NEW	3,600 lm	28 W	4000 K	1,490 mm	73 mm	82.20
78014114	NEW	4,500 lm	35 W	4000 K	1,190 mm	94 mm	75.80
78015114	NEW	6,900 lm	51 W	4000 K	1,490 mm	94 mm	92.80

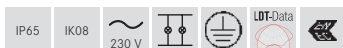

These items are subject to discount group 2.

Accessories for HUMID ONE LED moisture-proof tub l



Item no.		Description	Price in €
81011060	NEW	Through-wiring for 78011..., 580 mm, The set comprises: Line 3 x 1.5 mm ² (rigid), terminal block on one side including screws	4.90
81011120	NEW	Through-wiring for 78012... / 78014..., 1,190 mm, The set comprises: Line 3 x 1.5 mm ² (rigid), terminal block on one side including screws	6.90
81011150	NEW	Through-wiring for 78013... / 78015..., 1,490 mm, The set comprises: Line 3 x 1.5 mm ² (rigid), terminal block on one side including screws	8.90

These items are subject to discount group 2.

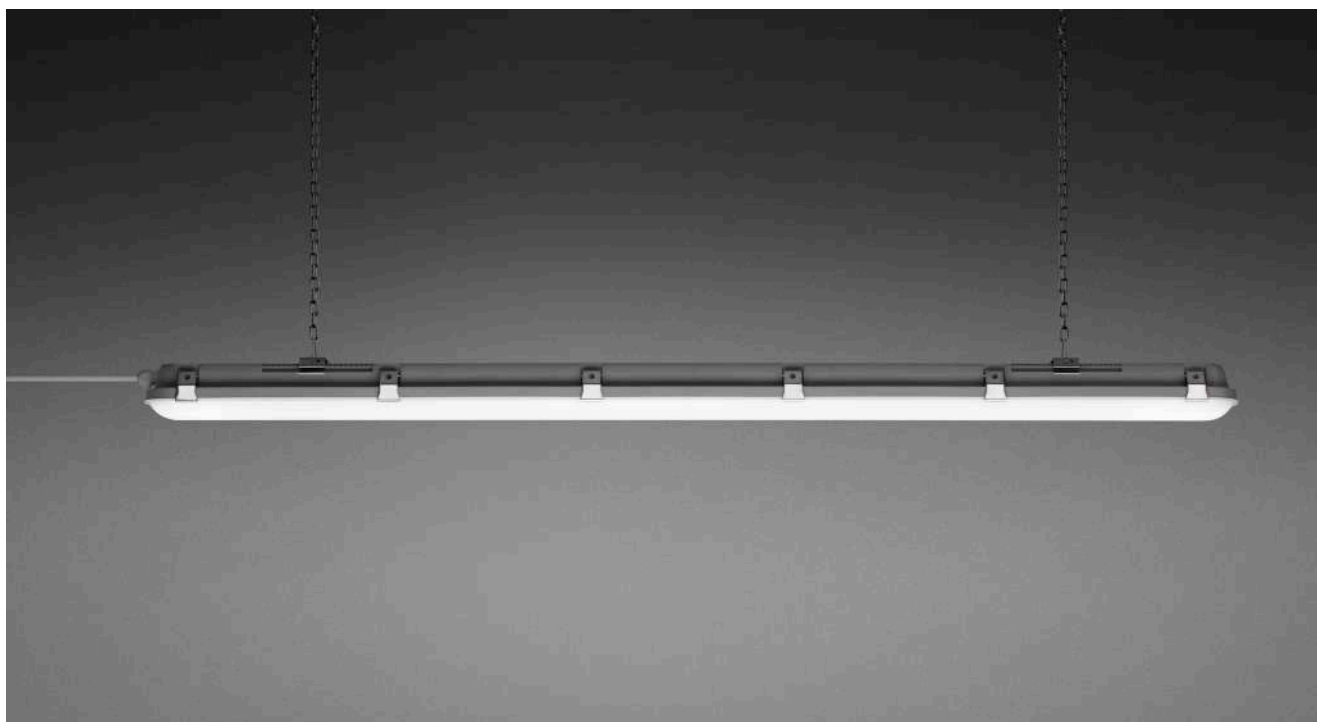

1

Interior lighting



10

Highbay, downlights.

The perfect choice for industrial halls illuminated according to standards.

Highbay SOL

Page 424



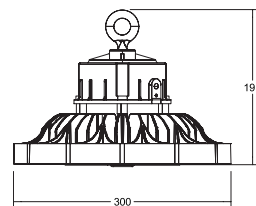
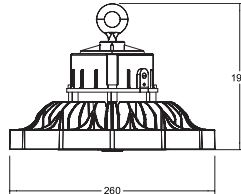
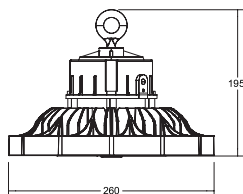

SOL LED downlight, dimmable DALI

NEW

Highbay LED downlight including power supply for 230 V mains voltage, dimmable DALI-2

Illuminants: LED, color rendering: CRI > 80, beam angle: 120°, material: Aluminum / polycarbonate, delivery: including screwable fixing eye and 1,500 mm connection cable

Item no.	Color	Luminous flux	Color temperature	Power	Diameter	Height	Price €
78310084	NEW Black	12,800 lm	4000 K	80 W	260 mm	195 mm	229.00
78311084	NEW Black	19,200 lm	4000 K	120 W	260 mm	195 mm	259.00
78312084	NEW Black	25,600 lm	4000 K	160 W	300 mm	195 mm	299.00



These items are subject to discount group 2.

Accessories for SOL downlights

Item no.	Description	Price in €
81060000	NEW Interchangeable optics SOL 60° for 78310 / 78311	9.90
81090000	NEW Interchangeable optics SOL 90° for 78310 / 78311	9.90
81062000	NEW Interchangeable optics SOL 60° for 78312	9.90
81092000	NEW Interchangeable optics SOL 90° for 78312	9.90
81045250	NEW SOL aluminum luminaire shade for 78310 / 78311	27.00
81046250	NEW SOL aluminum luminaire shade for 78312	31.00
81048000	NEW SOL PC luminaire shade for 78312	65.00
81044080	NEW SOL ceiling / wall bracket for 78310 / 78311	25.00
81049080	NEW SOL ceiling / wall bracket for 78312	27.00
81051000	NEW SOL chain suspension, 1,000 mm	9.00
81052000	NEW SOL chain suspension, 2,000 mm	18.00
81053000	NEW SOL chain suspension, 3,000 mm	27.00
81055000	NEW SOL chain suspension, 5,000 mm	45.00
81057000	NEW SOL cable connector, 3-pin, IP68, black	9.90
81058000	NEW SOL Y-cable connector, 5-pin, IP68, black	11.00
81050000	NEW SOL reducer, NPT 3/4" on M10	16.90

These items are subject to discount group 2.



Reducer



Y-cable connector



Interchangeable optics



Aluminum luminaire shade



PC luminaire shade



Ceiling / wall bracket



Chain suspension



Cable connector

SOL Highbay LED downlights.

Safe and effective illumination for industrial facilities.



Key features of the products:

- Dimmable DALI-2 by default.
- Coordinated accessories.
- High light yield of 160 lm per watt.
- Protection class: IP65.
- 5-year warranty.
- Low maintenance lighting realization.

The SOL Highbay LED downlights by Brumberg are especially suited for large industrial facilities with their high luminous efficacy of 160 lumens per watt and power ratings of 80 watts, 120 watts and 160 watts ascending by size. Thanks to their built-in DALI-2 dimming, they can be adapted as per the room requirements. In addition, LED-Highbays are more durable and energy efficient than hall mirror luminaires. Furthermore, they do not contain toxic substances such as mercury. Thus, they ensure more safety at the workplace.

1

Interior lighting

11

Fiber technology.

Relaxing lighting and a cozy ambience.

Starry sky LED fiber technology
LED fiber technology projectors

Page 428
Page 433

Accessories

Page 434



Private house, Bonn

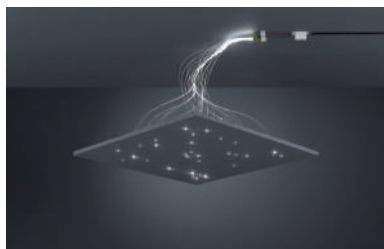
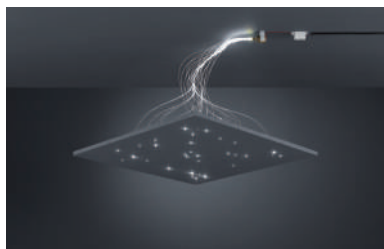

LED starry sky sets

- Comprising:
- 1x mini projector - 1 W power LED (D 26 x L 35 mm)
 - 1x 33-part assembled fiber bundle: 33 x Ø 1.0 mm, length: 1,000 mm
 - Including converter for power LED (L 52 x W 30 x H 23 mm) for connection with 230 V mains voltage
 - Without fans (thus no noise generation)

The ceiling panel shown is not included in the scope of delivery.

Two of these sets are designed for an area of approximately 1 m².

LED starry sky sets

- Comprising:
- 1x mini projector - 1 W power LED (D 26 x L 35 mm)
 - 1 x fiber bundle: 50-part mixed fiber
 - 15 x Ø 0.5 mm, length: 1,000 mm, 20 x Ø 0.75 mm, length: 1,000 mm, 10 x Ø 1.0 mm, length: 1,000 mm, 5 x Ø 1.5 mm, length: 1,000 mm
 - Including converter for power LED (L 52 x W 30 x H 23 mm) for connection with 230 V mains voltage
 - Without fans (thus no noise generation)

The ceiling panel shown is not included in the scope of delivery.

This set is designed for an area of approximately 1 m².

Item no.	Color temperature	Price €
9513W	6500 K	159.90
9513WW	3000 K	159.90

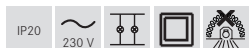

Special product * (for details, see page 439)

Item no.	Color temperature	Price €
9510W	6500 K	189.90
9510WW	3000 K	189.90

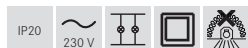

Special product * (for details, see page 439)\



LED starry sky sets

- Comprising:
- 1x projector - 20 W power LED (L 290 x W 105 x H 105 mm)
 - 1x 200-part assembled fiber bundle:
 - 100 x Ø 1.0 mm, length: 1,500 mm
 - 100 x Ø 1.0 mm, length: 3,000 mm
 - Color temperature: neutral white (4000 K)
 - Including 1,500-mm connection cable with Schuko plug
 - Including converter for connection with 230 V mains voltage
 - Without fans (thus no noise generation)

This set is designed for an area of approximately 4-5 m².

LED starry sky sets

- Comprising:
- 1 x projector - 1 x power LED (1.0 W) (L 180 x W 65 x H 35 mm)
 - 1x 100-part assembled fiber bundle (length: 1,500 mm each):
 - 30 x Ø 0.5 mm
 - 40 x Ø 0.75 mm
 - 20 x Ø 1.0 mm
 - 10 x Ø 1.5 mm
 - Including 1,500-mm connection cable with Schuko plug
 - Including converter for connection with 230 V mains voltage
 - Without fans (thus no noise generation)

This set is designed for an area of approximately 2-3 m².

Item no.	Color temperature	Price €
48210004	4000 K	879.90

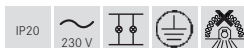

Special product * (for details, see page 439)

Item no.	Color temperature	Price €
48211005	6500 K	349.90
48211003	3000 K	349.90

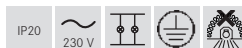

Special product * (for details, see page 439)



LED RGB+W starry sky set

NEW

LED RGB+W starry sky set

Comprising:

1 x projector - 8 W power LED RGB+W (W = 2850 K)

L 270 x W 155 x H 100 mm

1 x radio remote control

1x 200-part assembled fiber bundle:

50 x Ø 1.0 mm, length = 1,000 mm

50 x Ø 1.0 mm, length = 1,500 mm

50 x Ø 1.0 mm, length = 2,000 mm

50 x Ø 1.0 mm, length = 2,500 mm

Including 1,500-mm connection cable with Schuko plug

Including power supply for connection with 230 V mains voltage, without fans (thus no noise generation)

LED color control using radio remote control,

radio frequency: 869.5 MHz, transmission power (Ps) < 0 dBm, range (line-of-sight): approximately 5 m

Scope of function of the remote control:

- On / Off

- White light selector switch (ww / nw / w)

- RGB color change using a touch wheel

- Dimmer switch for red / green / blue

- Dimming of the set Color temperature

- A total of 10 different color program selection options

This set is designed for an area of approximately 4-5 m².

Power: 8 W

Item no.	Color temperature	Price €
48221002	NEW RGB+W	1,144.20

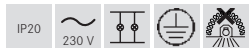

Special product * (for details, see page 439)



LED RGB starry sky set

Comprising:

- 1 x projector - 1 x LED RGB multi-color (1.0 W) (L 180 x W 65 x H 35 mm), including converter for connection with 230 V mains voltage
- 1 x 75-part assembled fiber bundle: 75 x Ø 1.0 mm, length: 1,500 mm
- 1 x radio remote control, range (line-of-sight): approximately 5 m

Functions:

- Switch on/off, program selection, direct selection of static colors, brightness adjustment
- Including 1,500-mm connection cable with Schuko plug
- Without fans (thus no noise generation)

This set is designed for an area of approximately 1-2 m².

Item no.	Color temperature	Price €
48222001	RGB	359.90

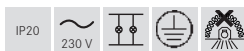

Special product * (for details, see page 439)

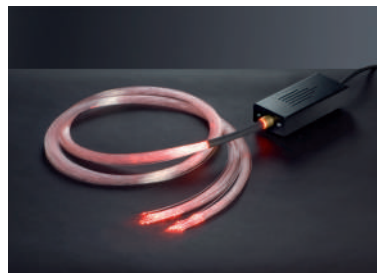

LED RGB starry sky set

Comprising:

- 1 x projector - 1 x LED RGB multi-color (1.0 W) (L 180 x W 65 x H 35 mm), including converter for connection with 230 V mains voltage
- 1 x 100-part assembled fiber bundle: 30 x Ø 0.5 mm, 40 x Ø 0.75 mm, 20 x Ø 1.0 mm, 10 x Ø 1.5 mm
- Length: 1,500 mm each
- 1 x radio remote control, range (line-of-sight): approximately 5 m

Functions:

- Switch on/off, program selection, direct selection of static colors, brightness adjustment
- Including 1,500-mm connection cable with Schuko plug
- Without fans (thus no noise generation)

This set is designed for an area of approximately 2 m².

Item no.	Color temperature	Price €
48224001	RGB	469.90

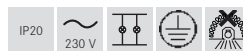

Special product * (for details, see page 439)

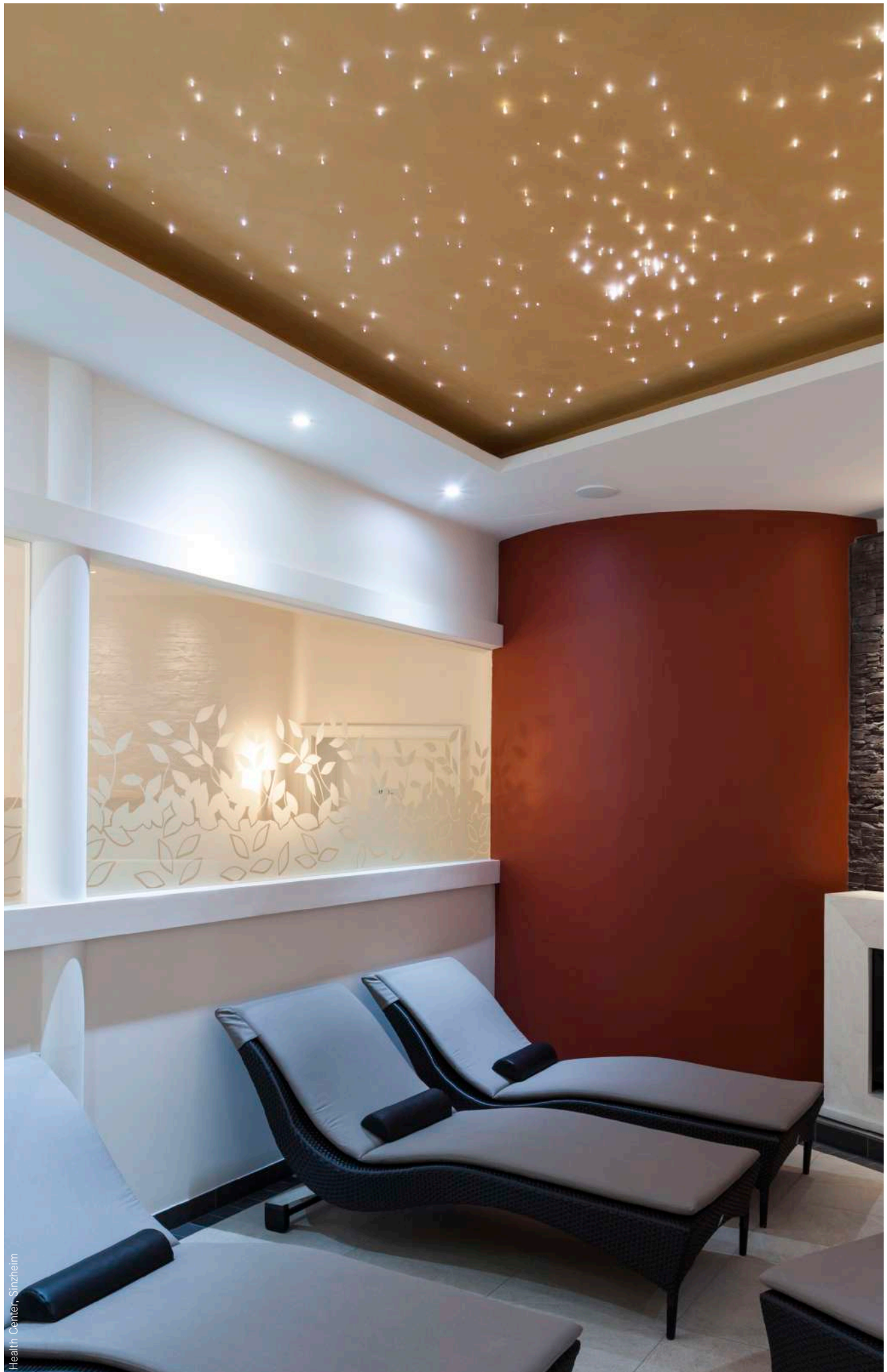

Health Center, Sinzheim



LED fiber projector

Comprising:

- 1 x LED projector, power: 3.6 W,
Dimensions: L 145 x W 80 x H 70 mm,
Housing material: Steel, housing color: black
- Including illuminants: 3 x LED (3 x 1.2 W) white or warm white
- Including 1,500-mm connection cable with Schuko plug
- Including converter for connection with 230 V mains voltage
- Without fans (thus no noise generation)
- Inner diameter of the connector receptacle: 30 mm

Item no.	Color temperature	Price €
9419W	6500 K	295.00
9419WW	3000 K	295.00

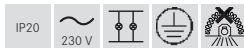

Special product * (for details, see page 439)



LED fiber projector

Comprising:

- 1 x LED projector, power: 20 W,
Dimensions: L 290 x W 105 x H 105 mm,
Material: Steel, housing color: black
- Including illuminants: LED, Color temperature: neutral white (4000 K)
- Including 1,500-mm connection cable with Schuko plug
- Including converter for connection with 230 V mains voltage
- Without fans (thus no noise generation)
- Inner diameter of the connector receptacle: 30 mm

Item no.	Color temperature	Price €
48201084	4000 K	569.90

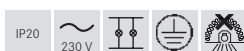

Special product * (for details, see page 439)



LED-RGB+W fiber projector

NEW

Comprising:

- 1 x LED-RGB+W projector
Power: 8 W, LED-RGB+W (W = 2850 K),
Dimensions: L 270 x W 155 x H 100 mm,
Housing material: Steel, housing color: black
- Including radio remote control including 1,500-mm connection cable with Schuko plug
- Including power supply for connection with 230 V mains voltage
- Without fans (thus no noise generation)
- Inner diameter of the connector receptacle: 30 mm
- LED color control using radio remote control, radio frequency 869.5 MHz, transmission power (Ps) < 0 dBm, range (line-of-sight): approximately 5 m.

Scope of function of the remote control:

- On / Off
- White light selector switch (ww / nw / w)
- RGB color change using a touch wheel
- Dimmer switch for red / green / blue
- Dimming of the set Color temperature
- A total of 10 different color program selection options

Item no.	Color temperature	Price €
48202082	NEW RGB+W	744.20

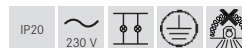

Special product * (for details, see page 439)



Fiber connector including assembly

Base element for bundling the fibers in the connector head. Including cutting the fibers to length as well as welding, casting and polishing the fibers.

Item no.	Price €
900000	256.50



1.0 mm fiber (S0), transparent, running meter

- Fiber: Ø 1.0 mm
- Active core: Ø 1.0 mm
- Minimum bending radius: 5.0 mm
- Hole diameter: Ø 1.1 mm

Item no.	Price €
910000	1.50



2.0 mm fiber (S2), transparent, running meter

- Fiber: Ø 2.0 mm
- Active core: Ø 2.0 mm
- Minimum bending radius: 10.0 mm
- Hole diameter: Ø 2.2 mm

Item no.	Price €
910200	7.20



3.0 mm fiber (S3), transparent, running meter

- Fiber: Ø 3.0 mm
- Active core: Ø 3.0 mm
- Minimum bending radius: 15.0 mm
- Hole diameter: Ø 3.2 mm

Item no.	Price €
910400	15.50



1.0 mm fiber (S1M), unsheathed, running meter

- Fiber: Ø 1.0 mm with protective hose
- Active core: Ø 1.0 mm
- Total diameter: Ø 3.0 mm
- Minimum bending radius: 10.0 mm
- Hole diameter: Ø 1.9 mm

Item no.	Price €
910100	9.20



2.0 mm fiber (S2M), unsheathed, running meter

- Fiber: Ø 2.0 mm with protective hose
- Active core: Ø 2.0 mm
- Total diameter: Ø 4.0 mm
- Minimum bending radius: 15.0 mm
- Hole diameter: Ø 2.9 mm

Item no.	Price €
910300	12.10



3.0 mm fiber (S3M), unsheathed, running meter

- Fiber: Ø 3.0 mm with protective hose
- Active core: Ø 3.0 mm
- Total diameter: Ø 5.0 mm
- Minimum bending radius: 20.0 mm
- Hole diameter: Ø 3.9 mm

Item no.	Price €
910500	22.80



Mixed fiber (S50M), unsheathed, running meter

- 1 x 50-part fiber bundle, comprising:
 - 15 x Ø 0.5 mm
 - 20 x Ø 0.75 mm
 - 10 x Ø 1.0 mm
 - 5 x Ø 1.5 mm
- Minimum bending radius: 25.0 mm
- Total diameter: Ø 10.0 mm

Item no.	Price €
910800	50.70



Acrylic emission element, for fiber S0

Material: Acrylic,
 Outer diameter: Ø 5 mm,
 Installation height: 4 mm,
 Installation depth without fiber: 8 mm,
 Installation depth with fiber: 25 mm,
 Hole diameter: Ø 3 mm to Ø 4 mm - depending on the material,
 Fastening type: Gluing

Item no.	Price €
975100	2.00



Acrylic emission element, for fiber S2

Material: Acrylic,
 Outer diameter: Ø 10 mm,
 Installation height: 4 mm,
 Installation depth without fiber: 8 mm,
 Installation depth with fiber: 40 mm,
 Hole diameter: Ø 7 mm to Ø 8 mm - depending on the material,
 Fastening type: Gluing

Item no.	Price €
975400	2.20



Mounting sleeve for 975100

Material: Brass,
 Outer diameter: Ø 9 mm,
 High outer ring: 1 mm,
 Installation depth without 975100: 8 mm,
 Installation depth with 975100: 20 mm,
 Hole diameter: Ø 5 mm to Ø 5.5 mm - depending on the material,
 Fastening type: Gluing

Item no.	Color	Price €
9760.02	Chromium	10.60



Mounting sleeve for 975400

Material: Brass,
 Outer diameter: Ø 14 mm,
 High outer ring: 1 mm,
 Installation depth without 975400: 9 mm,
 Installation depth with 975400: 100 mm,
 Hole diameter: Ø 9 mm to Ø 10 mm - depending on the material,
 Fastening type: Gluing

Item no.	Color	Price €
9761.02	Chromium	11.40



**Mounting sleeve
for 9730.. 9728. 9731. 9733.**

Material: Brass,
Hole diameter: Ø 12.7 mm to Ø 13 mm - depending on the material,
Length: approximately 30 mm

Item no.	Price €
973500	8.40

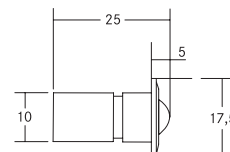
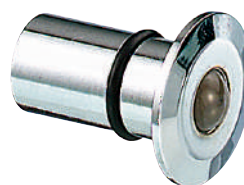

**Glass sphere emission element,
for fibers S2 and S2M**

Material: Brass / Glass,
Outer diameter: Ø 17.5 mm,
Height without glass sphere: 1.5 mm,
Installation depth without fiber: 20 mm,
Installation depth with fiber: 100 mm,
Hole diameter: Ø 10 mm,
Fastening type: Gluing

Item no.	Color	Price €
9730.03	Chromium matte	20.40
9730.05	Gold	20.40
9730.15	Nickel matte	20.40

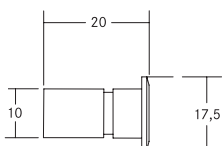

Emission element, for fibers S2 and S2M

Material: Brass,
Outer diameter: Ø 17.5 mm,
High outer ring: 1.5 mm,
Installation depth without fiber: 20 mm,
Installation depth with fiber: 100 mm,
Hole diameter: Ø 10 mm,
Fastening type: Gluing

Item no.	Color	Price €
9728.03	Chromium matte	17.00
9728.05	Gold	18.30
9728.15	Nickel matte	17.00

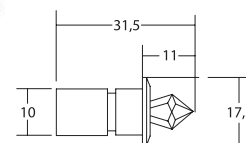

**Crystal emission element,
for fibers S2 and S2M**

Material: Brass / Crystal glass with facet cut,
Outer diameter: Ø 17.5 mm,
Height without crystal: 1.5 mm,
Installation depth without fiber: 20 mm,
Installation depth with fiber: 100 mm,
Hole diameter: Ø 10 mm,
Fastening type: Gluing

Item no.	Color	Price €
9731.03	Chromium matte	23.20
9731.05	Gold	23.20
9731.15	Nickel matte	23.20

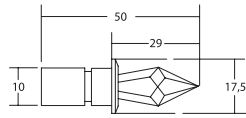

Crystal emission element, for fibers S2 and S2M

Material: Brass / Crystal glass with facet cut,
 Outer diameter: Ø 17.5 mm,
 Height without crystal: 1.5 mm,
 Installation depth without fiber: 20 mm,
 Installation depth with fiber: 100 mm,
 Hole diameter: Ø 10 mm,
 Fastening type: Gluing

Item no.	Color	Price €
9733.03	Chromium matte	31.00
9733.05	Gold	31.00
9733.15	Nickel matte	31.00



Adhesive for fiber outlet elements

1 x Weicon "Contact adhesive", 12 g,
 Suitable for bonding light emitting elements in the ceiling area, NOT suitable for bonding the actual PMMA fibers!

Item no.	Price €
48290000	23.10



Fiber technology installation kit

Comprising:

- 1x cutting tool for shortening the fibers S0, S2 and S3
- 1x drill set comprising 10 drills of 1.1 mm for fiber S0
- 1x wood glue for bonding the PMMA fibers
- 1x 2-component adhesive for bonding the PMMA fibers

Item no.	Price €
90199	159.90

Fiber optics technology

Effectively stage rooms with PMMA plastic fibers

1. The light source (230 V AC / 50 Hz)

- “Ready-to-plug” housing for connection with a conventional 230 V socket
- LED technology with low energy consumption and long service life
- Compact design
- Dimmable and controllable with different control techniques
- Color control

2. Fibers

- Natural light transport
- High flexibility due to small bending radius
- Maximum number of fibers per projector
500 x S0 (Ø 1.0 mm); 130 x S2 (Ø 2.0 mm);
50 x S3 (Ø 3.0 mm)
- Combination of different fibers is possible (on request)

3. End pieces

- Potential-free
- Temperature-free light
- No UV/IR radiation
- Simple installation.
- Wide range of decorative and technical end pieces



Maximum bundling of fiber pieces per connector

S0	S2	S3	S1M	S2M	S3M	S50M
500	130	50	300	130	40	8

Fiber installation

Five simple steps to the starry sky



- **1. Distribute light points and drill holes**
For ceiling sizes up to 10 m², we recommend 50 fibers/m²; above that, 30 to 40 fibers/m² will suffice. Easy installation of fibers; e.g. drill a hole of 1.1 mm for a fiber thickness of 1.0 mm. To prevent the visible side from breaking out, please drill the holes from the visible side.
- **2. Insert fibers into the holes.**
Allow the fiber to protrude sufficiently. The fibers will be shortened later.
- **3. Glue the fibers above the ceiling panel.**
- **4. If necessary, paint the ceiling.**
- **5. Shorten fibers below the ceiling panel (leave 3-5 mm protruding - the system is thus prepared for future renovations).**

Special product

Special product - fiber optic lighting systems

Intended use: The principle of fiber optic lighting systems is the transmission of light through a fiber optic bundle. These systems are used for decorative illumination. It is used here for the construction of an "artistic starry sky".

Any other application, outside this purpose is not allowed. This product is not suitable for room lighting in households.

Areas of application

Indoor areas:

Offices, elevators, lobbies, handrails, starry skies, directional signs, all-around lighting

Outdoor areas (use sheathed fibers):

Facades, stairs, columns, canopies, fountains, advertising signs, direction signposts

Public zones:

Art halls, museums, parks, stadiums, bridges, airports, churches, hospitals

Installation of fiber optic systems

- The projector should be positioned such that it is possible to change the light source at any time.
 - When planning the system, the projector should be placed as centrally as possible to keep the fiber length short.
 - For trouble-free installation of the bundle, there should be 300 mm free space at the connector input side.
 - The connection can be made via a ceiling connector or via a socket.
 - Ensure that the fiber end point is not exposed to temperatures above 90 °C.
 - The fiber must only be fixed with adhesives from our range.
- See the adjacent page: Item 90199

1

Interior lighting

12

Rescue sign luminaires.

Reliable, standard-compliant illumination for emergency situations.

LED rescue sign luminaires

Page 442



Eiswiese (Ice meadow), Göttingen

LED rescue sign luminaires.

Find your way in an emergency.



Key features of the products:

- Made in Germany, 5-year warranty.
- High durability and storage times due to LiFePO₄ (lithium iron phosphate) rechargeable batteries.
- One luminaire for all operating hours.
- 8 hours in lodging facilities.
- 3 hours for all other areas.
- Self-adhesive pictogram set, quick replacement.
- Illumination of the rescue sign > 200 cd/m².
- Technical design in accordance with EN 60598.2.22.
- Everything with AUTOTEST – function and test LEDs that are visible from outside.

They are mandatory in public buildings and can save lives in an emergency: Rescue sign luminaires provide the necessary orientation and mark emergency exits. Brumberg's luminaires stay on for three hours or eight hours (for lodging facilities) in emergency mode. With the pluggable pictograms, escape routes can be marked on one or two sides. Brumberg offers the luminaires as recessed or pendant luminaires for ceiling or wall mounting.

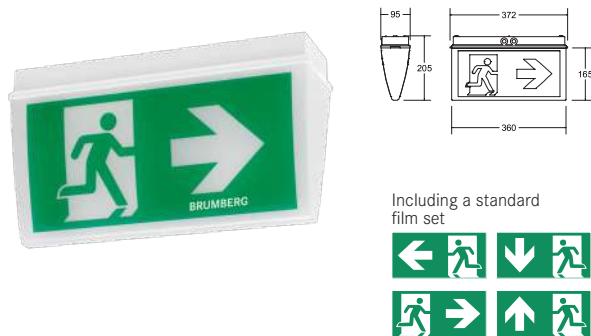

REASCUE ONE LED rescue sign luminaire, ceiling or wall surface-mounting NEW

Detection range (DR): 32 m, nominal operating time 3 h, nominal operating time can be changed to 8 h, then the emergency lighting factor (BLF) is still 40%, ceiling or wall mounting, including LiFe-PO4 single battery and pictogram set

Illuminants: LED, lamp power: 2.4 W, system power: 4.6 W, material: Polycarbonate, rechargeable battery type: LiFe-PO4, monitoring device: automatic self-test

Other pictogram films can be made available on request.

Item no.	Color temperature	Detection range (DR)	Nominal operating duration at BLF 100%	Nominal operating duration at BLF 40%	Price €
79030004	4000 K	32 m	3 h	8 h	159.00



This item is subject to discount group 2.

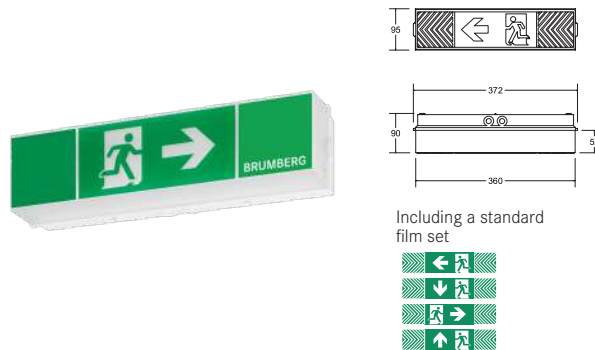

REASCUE ONE LED rescue sign luminaire, wall-mounting NEW

Detection range (DR): 18 m, nominal operating time 3 h, nominal operating time can be changed to 8 h, then the emergency lighting factor (BLF) is still 40%, ceiling or wall mounting, including LiFe-PO4 single battery and pictogram set

Illuminants: LED, lamp power: 2.4 W, system power: 4.6 W, material: Polycarbonate, rechargeable battery type: LiFe-PO4, monitoring device: automatic self-test

Other pictogram films can be made available on request.

Item no.	Color temperature	Detection range (DR)	Nominal operating duration at BLF 100%	Nominal operating duration at BLF 40%	Price €
79130004	4000 K	18 m	3 h	8 h	139.00



This item is subject to discount group 2.

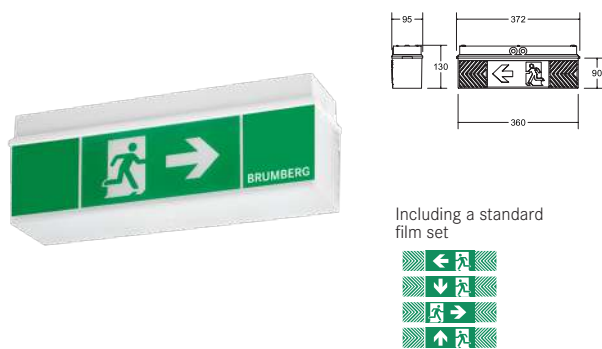

REASCUE ONE LED rescue sign luminaire, ceiling or wall surface-mounting NEW

Detection range (DR): 18 m, nominal operating time 3 h, nominal operating time can be changed to 8 h, then the emergency lighting factor (BLF) is still 40%, ceiling or wall mounting, including LiFe-PO4 single battery and pictogram set

Illuminants: LED, lamp power: 2.4 W, system power: 4.6 W, material: Polycarbonate, rechargeable battery type: LiFe-PO4, monitoring device: automatic self-test

Other pictogram films can be made available on request.

Item no.	Color temperature	Detection range (DR)	Nominal operating duration at BLF 100%	Nominal operating duration at BLF 40%	Price €
79031004	4000 K	18 m	3 h	8 h	149.00



This item is subject to discount group 2.

Optional accessory:

- Pendant set for 7903... / 7913...**
81172050 pendant set 500 mm, price in €: 54.70
- 81172100 pendant set 1,000 mm, Price in €: 61.50
- Ceiling recessed set for 7903... / 7913...**
81173000 ceiling recessed set Price in €: 82.00

These items are subject to discount group 2.

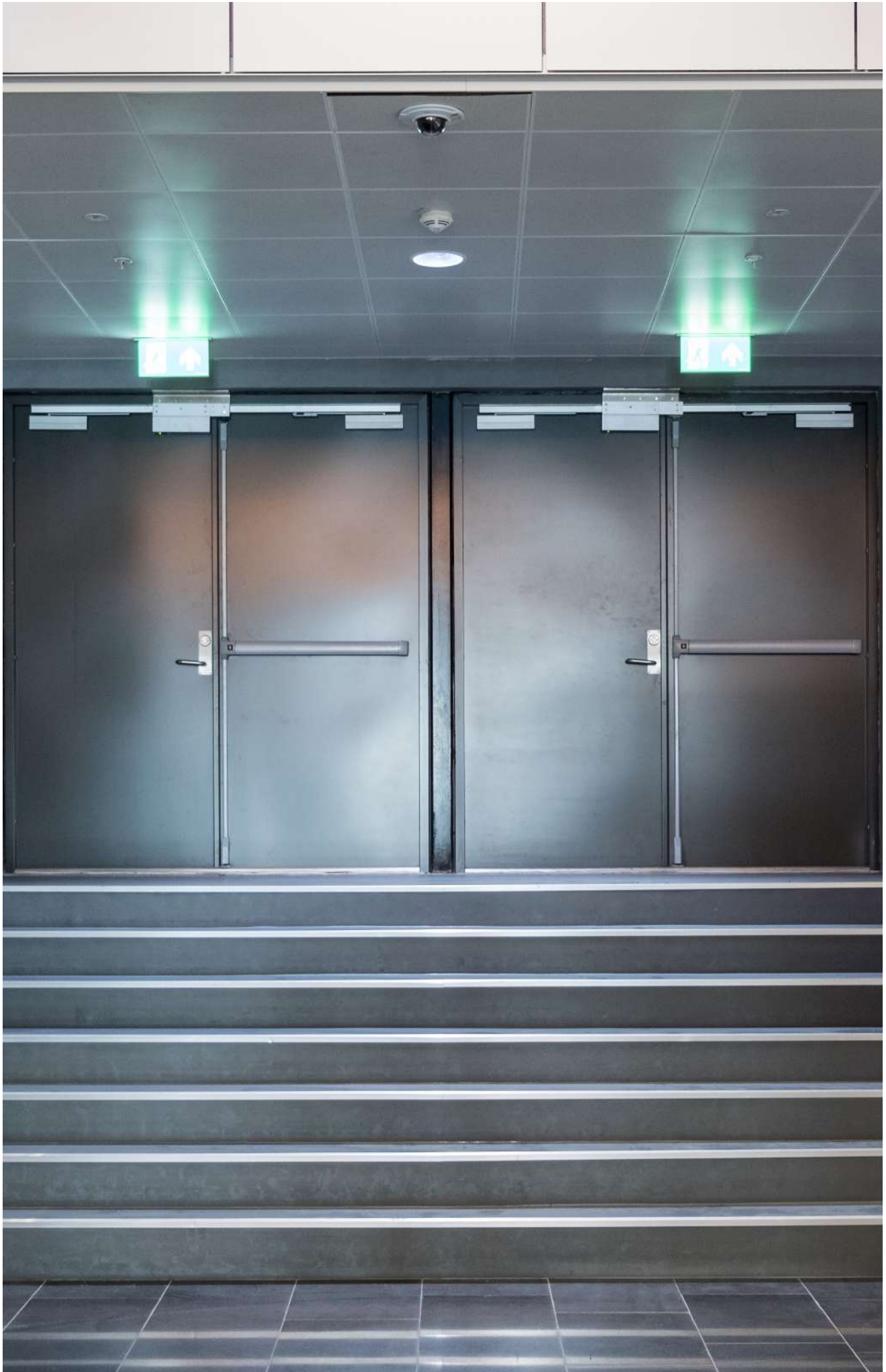



REASCUE TWO LED rescue sign luminaire, ceiling or wall surface-mounting NEW

Detection range (DR): 25 m, nominal operating time 3 h, nominal operating time can be changed to 8 h, then the emergency lighting factor (BLF) is still 40%, ceiling or wall mounting, including LiFe-PO4 single battery and pictogram set

Illuminants: LED, lamp power: 2.4 W, system power: 4.6 W, material: Aluminum / polycarbonate, rechargeable battery type: LiFePO4, monitoring device: automatic self-test

Other pictogram films can be made available on request.

Item no.	Color temperature	Detection range (DR)	Nominal operating duration at BLF 100%	Nominal operating duration at BLF 40%	Price €
79230264	4000 K	25 m	3 h	8 h	229.00



This item is subject to discount group 2.

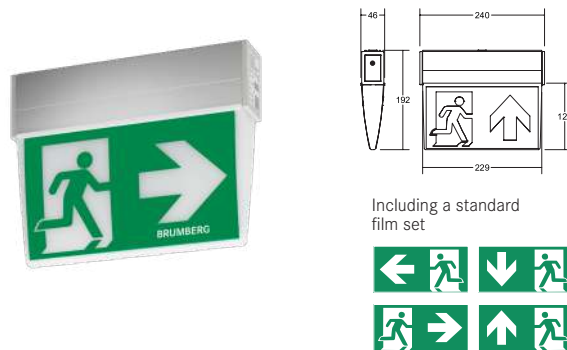

REASCUE TWO LED rescue sign luminaire, ceiling or wall surface-mounting NEW

Detection range (DR): 25 m, nominal operating time 3 h, nominal operating time can be changed to 8 h, then the emergency lighting factor (BLF) is still 40%, ceiling or wall mounting, including LiFe-PO4 single battery and pictogram set

Illuminants: LED, lamp power: 2.4 W, system power: 4.6 W, material: Aluminum / polycarbonate, rechargeable battery type: LiFePO4, monitoring device: automatic self-test

Other pictogram films can be made available on request.

Item no.	Color temperature	Detection range (DR)	Nominal operating duration at BLF 100%	Nominal operating duration at BLF 40%	Price €
79231264	4000 K	25 m	3 h	8 h	189.00



This item is subject to discount group 2.

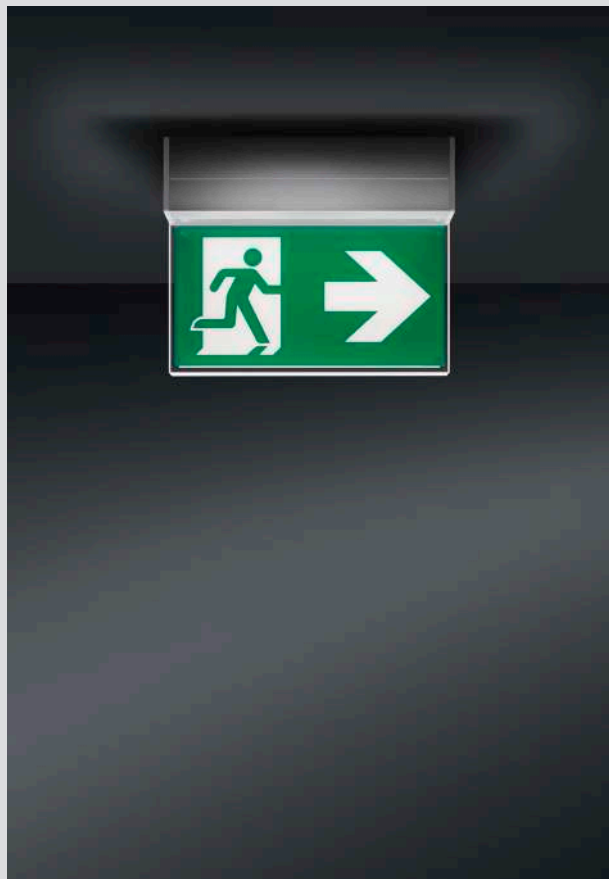

Optional accessory:



Central pendant set for 79230... and 79231...
 Length 300 mm, item no. 81170030, price in €: 37.60
 Length 500 mm, item no. 81170050, price in €: 41.00
 Length 1.000 mm, item no. 81170100, price in €: 44.40



Ceiling recessed set for 79230264
 Item no. 81171001
 Price in €: 61.50

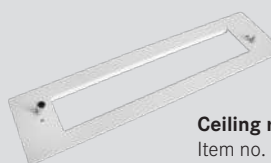

Ceiling recessed set for 79231264
 Item no. 81171000
 Price in €: 61.50

These items are subject to discount group 2.

2

Exterior lighting

13

Ceiling-mounted luminaires.

Effective general lighting
for the outdoor living room.

Recessed ceiling luminaires

Page 448

Ceiling-mounted luminaires

Page 460



Private house, Vredend

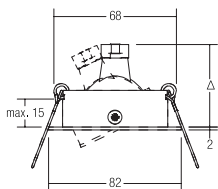

Recessed spotlight, V4A, GX5.3

Illuminants: For LED retrofit lamp, model: GX5.3, power: maximum 50 W, material: Stainless steel V4A, delivery: without circlip

Recessed spotlight, V4A, GU10

Including bracket with GU10 holder for standard-compliant strain relief.
Illuminants: For LED retrofit lamp, model: GU10, power: maximum 50 W, material: Stainless steel V4A

Item no.	Color	Price €
1180.22	Stainless steel	79.00



Item no.	Color	Price €
36147220	Stainless steel	90.00



LED recessed spotlight set V4A, switchable

Set including converter for 230 V mains voltage, switchable, dimensions of converter: L 68 x W 35 x H 21 mm

Illuminants: LED, color rendering: CRI > 80, power: 6 W, beam angle: 38°, material: Stainless steel V4A / Aluminum / Glass / Plastic

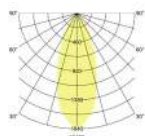

LED recessed spotlight set, V4A, dimmable phase section

NEW

Set including converter for 230 V mains voltage, dimmable phase section, dimensions of converter: L 110 x W 50 x H 19 mm

Illuminants: LED, color rendering: CRI > 80, power: 6 W, beam angle: 38°, material: Stainless steel V4A / Aluminum / Glass / Plastic

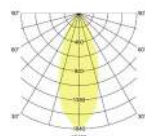

Item no.	Color	Luminous flux	Color temperature	Price €
38147223	Stainless steel	680 lm	3000 K	154.30

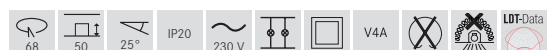

Item no.	Color	Luminous flux	Color temperature	Price €
39147223	NEW Stainless steel	680 lm	3000 K	158.20

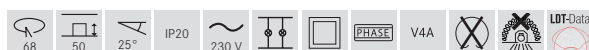

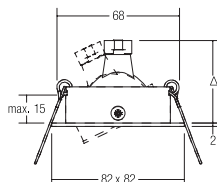

Recessed spotlight, V4A, GX5.3

Illuminants: For LED retrofit lamp, model: GX5.3, power: maximum 50 W, material: Stainless steel V4A, delivery: without circlip

Recessed spotlight, V4A, GU10

Including bracket with GU10 holder for standard-compliant strain relief.
 Illuminants: For LED retrofit lamp, model: GU10, power: maximum 50 W, material: Stainless steel V4A

Item no.	Color	Price €
1181.22	Stainless steel	84.30

Item no.	Color	Price €
36148220	Stainless steel	95.30



LED recessed spotlight set V4A, switchable

Set including converter for 230 V mains voltage, switchable, dimensions of converter: L 68 x W 35 x H 21 mm

Illuminants: LED, color rendering: CRI > 80, power: 6 W, beam angle: 38°, material: Stainless steel V4A / Aluminum / Glass / Plastic

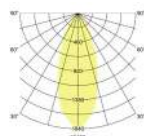

LED recessed spotlight set, V4A, dimmable phase section

NEW

Set including converter for 230 V mains voltage, dimmable phase section, dimensions of converter: L 110 x W 50 x H 19 mm

Illuminants: LED, color rendering: CRI > 80, power: 6 W, beam angle: 38°, material: Stainless steel V4A / Aluminum / Glass / Plastic

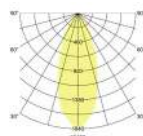

Item no.	Color	Luminous flux	Color temperature	Price €
38148223	Stainless steel	680 lm	3000 K	159.60

Item no.	Color	Luminous flux	Color temperature	Price €
39148223	NEW Stainless steel	680 lm	3000 K	163.50

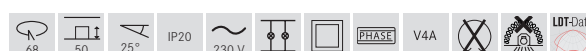
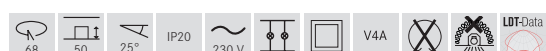

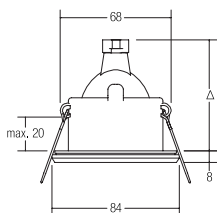

Recessed downlight, V4A, IP65, GX5.3

Illuminants: For LED retrofit lamp, model: GX5.3, power: maximum 50 W, material: Stainless steel V4A / Glass

Item no.	Color	Price €
2339.42	Stainless steel	68.10

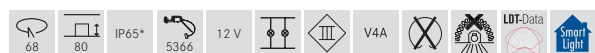

* IP65 when installed in closed ceilings

Recessed downlight, V4A, IP65, GU 10

Including bracket with GU10 holder for standard-compliant strain relief.

Illuminants: For LED retrofit lamp, model: GU10, power: maximum 50 W, material: Stainless steel V4A / Glass

Item no.	Color	Price €
36306420	Stainless steel	79.10

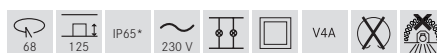

* IP65 when installed in closed ceilings

LED recessed downlight set, V4A, IP65, switchable

Set including converter for 230 V mains voltage, switchable, dimensions of converter: L 68 x W 35 x H 21 mm

Illuminants: LED, color rendering: CRI > 80, power: 6 W, beam angle: 38°, material: Stainless steel V4A / Aluminum / Glass / Plastic

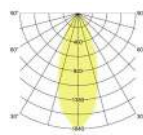

Item no.	Color	Luminous flux	Color temperature	Price €
38306423	Stainless steel	540 lm	3000 K	143.40

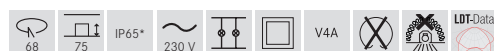

* IP65 when installed in closed ceilings

LED recessed downlight set, V4A, IP65, dimmable phase section

NEW

Set including converter for 230 V mains voltage, dimmable phase section, dimensions of converter: L 110 x W 50 x H 19 mm

Illuminants: LED, color rendering: CRI > 80, power: 6 W, beam angle: 38°, material: Stainless steel V4A / Aluminum / Glass / Plastic

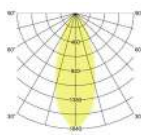

Item no.	Color	Luminous flux	Color temperature	Price €
39306423	NEW Stainless steel	540 lm	3000 K	147.30



* IP65 when installed in closed ceilings



STEAM recessed downlight, V4A, IP65

NEW

All Brumberg MR16 LED modules can be used for the STEAM recessed unit. The installation depth of the luminaire depends on the respective LED module used (here: 2 mm excluding the height of the LED module).

Illuminants: For LED, power: maximum 14 W, material: Stainless steel V4A / Aluminum / Glass, delivery: including LED module support on the rear side

You will find corresponding LED modules from page 504 onwards and corresponding converters from 516 onwards.

The LED module is not included in the scope of delivery of the recessed unit.



Caution: Pay attention to the height of the illuminant!

Item no.	Color	Price €
37005070	NEW White	68.80
37005420	NEW Stainless steel	71.40



* IP65 when installed in closed ceilings (in case of screw mounting)

STEAM recessed downlight, V4A, IP54

NEW

All Brumberg MR16 LED modules can be used for the STEAM recessed unit. The installation depth of the luminaire depends on the respective LED module used (here: 2 mm excluding the height of the LED module).

Illuminants: For LED, power: maximum 14 W, material: Stainless steel V4A / Aluminum / Glass, delivery: including LED module support on the rear side

You will find corresponding LED modules from page 504 onwards and corresponding converters from 516 onwards.

The LED module is not included in the scope of delivery of the recessed unit.



Caution: Pay attention to the height of the illuminant!

Item no.	Color	Price €
37006070	NEW White	73.50
37006420	NEW Stainless steel	77.40



* IP54 when installed in closed ceilings (spring mounting)

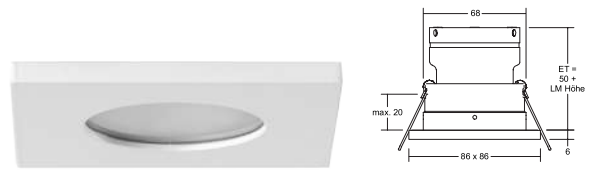

STEAM recessed downlight, V4A, IP65

NEW

All Brumberg MR16 LED modules can be used for the STEAM recessed unit. The installation depth of the luminaire depends on the respective LED module used (here: 50 mm excluding the height of the LED module).

Illuminants: For LED, power: LED, maximum 14 W, material: Stainless steel V4A / Aluminum / Glass, delivery: including LED module support on the rear side

You will find corresponding LED modules from page 504 onwards and corresponding converters from 516 onwards.

The LED module is not included in the scope of delivery of the recessed unit.



Caution: Pay attention to the height of the illuminant!

Item no.	Color	Price €
37015070	NEW White	71.20
37015420	NEW Stainless steel	73.30



* IP65 when installed in closed ceilings (in case of screw mounting)
High version with air buffer for e.g. hotter sauna areas.

STEAM recessed downlight, V4A, IP54

NEW

All Brumberg MR16 LED modules can be used for the STEAM recessed unit. The installation depth of the luminaire depends on the respective LED module used (here: 50 mm excluding the height of the LED module).

Illuminants: For LED, power: LED, maximum 14 W, material: Stainless steel V4A / Aluminum / Glass, delivery: including LED module support on the rear side

You will find corresponding LED modules from page 504 onwards and corresponding converters from 516 onwards.

The LED module is not included in the scope of delivery of the recessed unit.



Caution: Pay attention to the height of the illuminant!

Item no.	Color	Price €
37016070	NEW White	75.50
37016420	NEW Stainless steel	79.40



* IP54 when installed in closed ceilings (spring mounting)
High version with air buffer for e.g. hotter sauna areas.

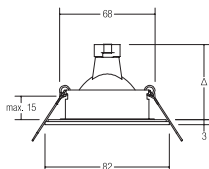

Recessed downlight, V4A, IP54, GX5.3

Illuminants: For LED retrofit lamp, model: GX5.3, power: maximum 35 W, material: Stainless steel V4A / Aluminum / Glass

Recessed downlight, V4A, IP54, GU10

Including bracket with GU10 holder for standard-compliant strain relief.
Illuminants: For LED retrofit lamp, model: GU10, power: maximum 35 W, material: Stainless steel V4A / Aluminum / Glass

Item no.	Color	Price €
26004070	White	58.00
26004220	Stainless steel	58.00

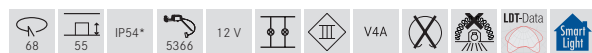

* IP54 when installed in closed ceilings

Item no.	Color	Price €
36004070	White	69.00
36004220	Stainless steel	69.00

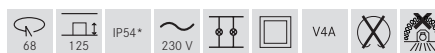

* IP54 when installed in closed ceilings

LED recessed downlight set BB15, V4A, IP54, switchable NEW

Set including converter for 230 V mains voltage, switchable, dimensions of converter: L 68 x W 35 x H 21 mm

Illuminants: LED, color rendering: CRI > 80, power: 6 W, beam angle: 38°, material: Stainless steel V4A / Aluminum / Glass / Plastic

Item no.	Color	Luminous flux	Color temperature	Price €
38375073	NEW White	680 lm	3000 K	86.90
38375423	Stainless steel	680 lm	3000 K	86.90

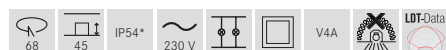

* IP54 when installed in closed ceilings

BB15 LED recessed downlight set, V4A, IP54, dimmable phase section

NEW

Set including converter for 230 V mains voltage, dimmable phase section, dimensions of converter: L 110 x W 50 x H 19 mm

Illuminants: LED, color rendering: CRI > 80, power: 6 W, beam angle: 38°, material: Stainless steel V4A / Aluminum / Glass / Plastic

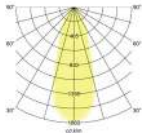

Item no.	Color	Luminous flux	Color temperature	Price €
39375073	NEW White	680 lm	3000 K	87.70
39375423	Stainless steel	680 lm	3000 K	87.70

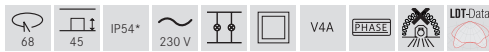

* IP54 when installed in closed ceilings

BB15 LED recessed downlight set, V4A, IP54, dimmable phase section, with connection box

NEW

Set including converter for 230 V mains voltage, dimmable phase section, dimensions of converter: L 110 x W 50 x H 19 mm

Illuminants: LED, color rendering: CRI > 80, power: 6 W, beam angle: 38°, material: Stainless steel V4A / Aluminum / Glass / Plastic, delivery: including connection box, 3-pin

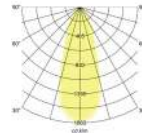

Item no.	Color	Luminous flux	Color temperature	Price €
39475073	NEW White	680 lm	3000 K	92.10
39475423	NEW Stainless steel	680 lm	3000 K	92.10

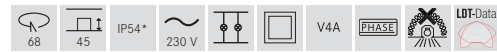

* IP54 when installed in closed ceilings

BB15 LED recessed downlight set, V4A, IP54, dimmable phase section (round converter)

NEW

Set including converter for 230 V mains voltage, dimmable phase section, dimensions of converter: D 51 x H 24 mm

Illuminants: LED, color rendering: CRI > 80, power: 6 W, beam angle: 38°, material: Stainless steel V4A / Aluminum / Glass / Plastic

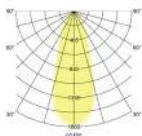

Item no.	Color	Luminous flux	Color temperature	Price €
40375073	NEW White	680 lm	3000 K	96.50
40375423	Stainless steel	680 lm	3000 K	96.50

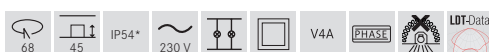

* IP54 when installed in closed ceilings

BB15 LED recessed downlight set, V4A, IP54, dimmable DALI, with connection box

NEW

Set including converter for 230 V mains voltage, dimmable DALI-2, dimensions of converter: L 130 x W 42 x H 22 mm

Illuminants: LED, color rendering: CRI > 80, power: 6 W, beam angle: 38°, material: Stainless steel V4A / Aluminum / Glass / Plastic, delivery: including connection box, 5-pin

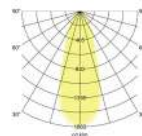

Item no.	Color	Luminous flux	Color temperature	Price €
41475073	NEW White	680 lm	3000 K	127.60
41475423	NEW Stainless steel	680 lm	3000 K	127.60

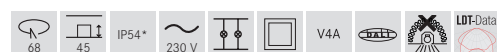

* IP54 when installed in closed ceilings

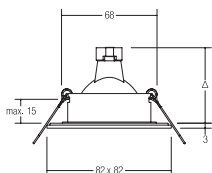

Recessed downlight, V4A, IP54, GX5.3

Illuminants: For LED retrofit lamp, model: GX5.3, power: maximum 35 W, material: Stainless steel V4A / Aluminum / Glass

Recessed downlight, V4A, IP54, GU10

Including bracket with GU10 holder for standard-compliant strain relief.
Illuminants: For LED retrofit lamp, model: GU10, power: maximum 35 W, material: Stainless steel V4A / Aluminum / Glass

Item no.	Color	Price €
26005070	White	60.40
26005220	Stainless steel	60.40

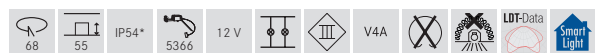

* IP54 when installed in closed ceilings

Item no.	Color	Price €
36005070	White	71.40
36005220	Stainless steel	71.40

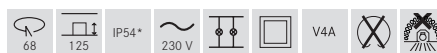

* IP54 when installed in closed ceilings

BB16 LED recessed downlight set, V4A, IP54, switchable NEW

Set including converter for 230 V mains voltage, switchable, dimensions of converter: L 68 x W 35 x H 21 mm

Illuminants: LED, color rendering: CRI > 80, power: 6 W, beam angle: 38°, material: Stainless steel V4A / Aluminum / Glass / Plastic

Item no.	Color	Luminous flux	Color temperature	Price €
38376073	NEW White	680 lm	3000 K	89.90
38376423	Stainless steel	680 lm	3000 K	89.90

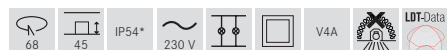

* IP54 when installed in closed ceilings

BB16 LED recessed downlight set, V4A, IP54, dimmable phase section

NEW

Set including converter for 230 V mains voltage, dimmable phase section, dimensions of converter: L 110 x W 50 x H 19 mm

Illuminants: LED, color rendering: CRI > 80, power: 6 W, beam angle: 38°, material: Stainless steel V4A / Aluminum / Glass / Plastic

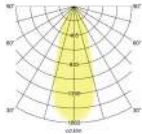

Item no.	Color	Luminous flux	Color temperature	Price €
39376073	NEW White	680 lm	3000 K	90.70
39376423	Stainless steel	680 lm	3000 K	90.70

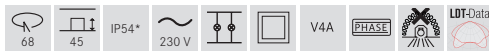

* IP54 when installed in closed ceilings

BB16 LED recessed downlight set, V4A, IP54, dimmable phase section, with connection box

NEW

Set including converter for 230 V mains voltage, dimmable phase section, dimensions of converter: L 110 x W 50 x H 19 mm

Illuminants: LED, color rendering: CRI > 80, power: 6 W, beam angle: 38°, material: Stainless steel V4A / Aluminum / Glass / Plastic, delivery: including connection box, 3-pin

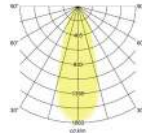

Item no.	Color	Luminous flux	Color temperature	Price €
39476073	NEW White	680 lm	3000 K	95.10
39476423	NEW Stainless steel	680 lm	3000 K	95.10

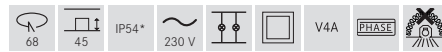

* IP54 when installed in closed ceilings

BB16 LED recessed downlight set, V4A, IP54, dimmable phase section (round converter)

NEW

Set including converter for 230 V mains voltage, dimmable phase section, dimensions of converter: D 51 x H 24 mm

Illuminants: LED, color rendering: CRI > 80, power: 6 W, beam angle: 38°, material: Stainless steel V4A / Aluminum / Glass / Plastic

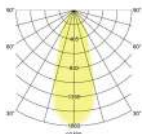

Item no.	Color	Luminous flux	Color temperature	Price €
40376073	NEW White	680 lm	3000 K	99.50
40376423	Stainless steel	680 lm	3000 K	99.50

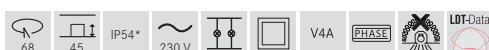

* IP54 when installed in closed ceilings

BB16 LED recessed downlight set, V4A, IP54, dimmable DALI, with connection box

NEW

Set including converter for 230 V mains voltage, dimmable DALI-2, dimensions of converter: L 130 x W 42 x H 22 mm

Illuminants: LED, color rendering: CRI > 80, power: 6 W, beam angle: 38°, material: Stainless steel V4A / Aluminum / Glass / Plastic, delivery: including connection box, 5-pin

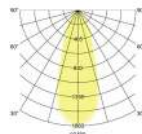

Item no.	Color	Luminous flux	Color temperature	Price €
41476073	NEW White	680 lm	3000 K	130.60
41476423	NEW Stainless steel	680 lm	3000 K	130.60

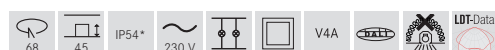

* IP54 when installed in closed ceilings

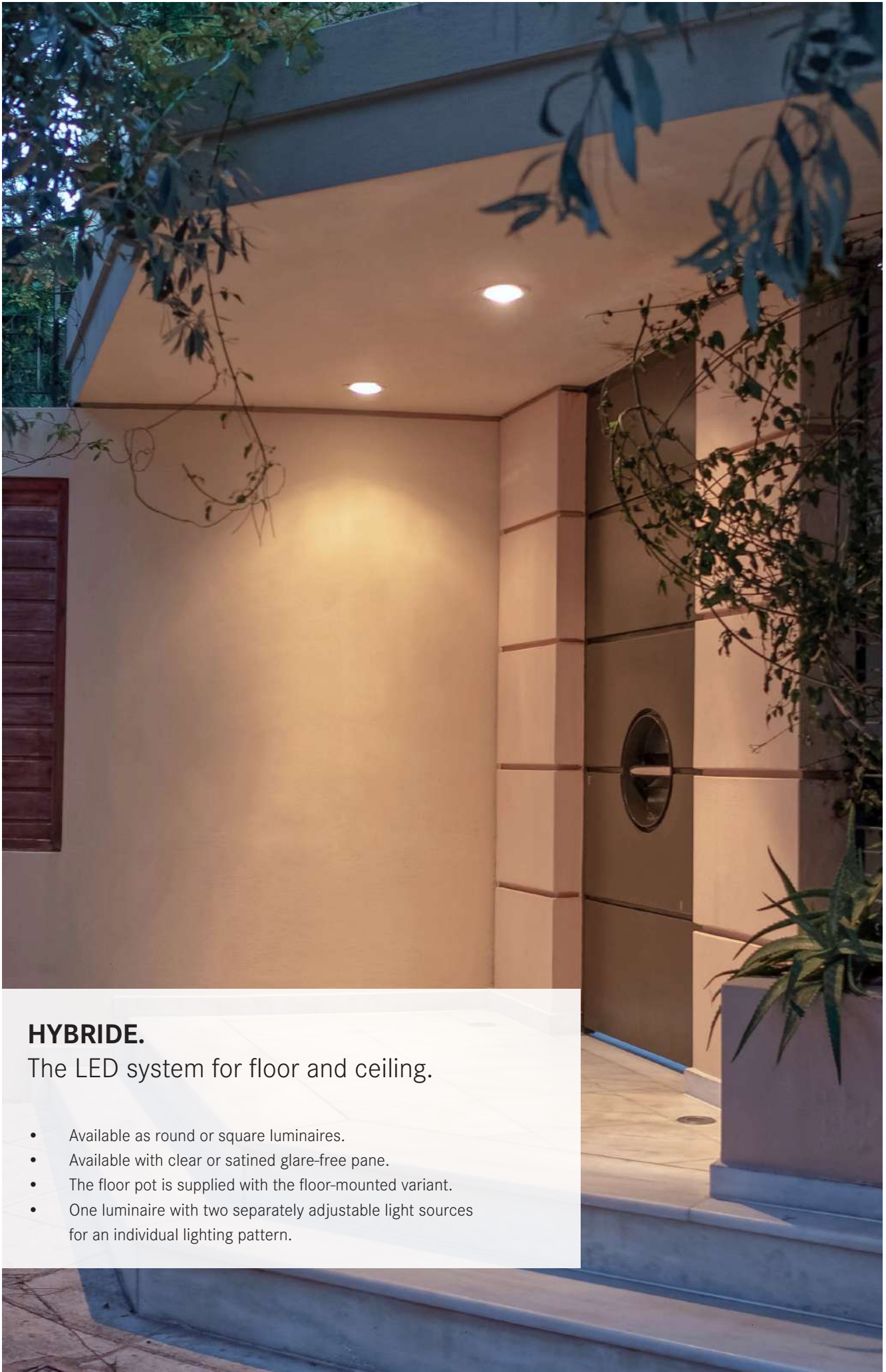

HYBRIDE.

The LED system for floor and ceiling.

- Available as round or square luminaires.
- Available with clear or satined glare-free pane.
- The floor pot is supplied with the floor-mounted variant.
- One luminaire with two separately adjustable light sources for an individual lighting pattern.



HYBRIDE LED recessed downlight, V4A, IP67

Illuminants: LED, color rendering: CRI > 80, power: 8 W, beam angle: 38°, material: Stainless steel V4A / Aluminum / Glass, delivery: including converter for connection with 230 V mains voltage, switchable and 5,000-mm connection cable

You will find hybrid floor variants on page 491.

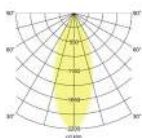

Item no.	Color	Luminous flux	Color temperature	Price €
12660223	Stainless steel	860 lm	3000 K	306.20



HYBRIDE LED recessed downlight, V4A, IP67

Illuminants: LED, color rendering: CRI > 80, power: 7 W, beam angle: 117°, material: Stainless steel V4A / Aluminum / Glass, delivery: including converter for connection with 230 V mains voltage, switchable and 5,000-mm connection cable

You will find hybrid floor variants on page 491.

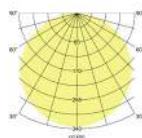

Item no.	Color	Luminous flux	Color temperature	Price €
12661223	Stainless steel	350 lm	3000 K	279.90



HYBRIDE LED recessed downlight, V4A, IP67

Illuminants: LED, color rendering: CRI > 80, power: 13 W, beam angle: 40°, material: Stainless steel V4A / Aluminum / Glass, delivery: including converter for connection with 230 V mains voltage, switchable and 5,000-mm connection cable

You will find hybrid floor variants on page 491.

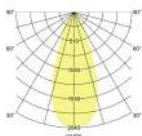

Item no.	Color	Luminous flux	Color temperature	Price €
12662223	Stainless steel	1,400 lm	3000 K	378.60



HYBRIDE LED recessed downlight, V4A, IP67

Illuminants: LED, color rendering: CRI > 80, power: 17 W, beam angle: 34°, material: Stainless steel V4A / Aluminum / Glass, delivery: including converter for connection with 230 V mains voltage, switchable and 5,000-mm connection cable

You will find hybrid floor variants on page 491.

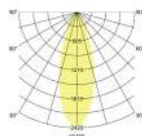

Item no.	Color	Luminous flux	Color temperature	Price €
12664223	Stainless steel	2,010 lm	3000 K	449.90





HYBRIDE LED recessed spotlight, V4A, IP67

Illuminants: LED, color rendering: CRI > 80, power: 2x 4.5 W, beam angle: 30°, luminous flux: 2 x 335 lm, material: Stainless steel V4A / Aluminum / Glass, delivery: including converter for connection with 230 V mains voltage, switchable, 5,000-mm connection cable and setting tool

You will find hybrid floor variants on page 489.

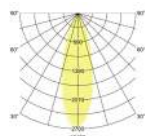

Two light sources can be individually set:

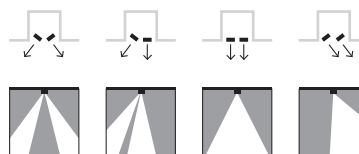

Setting tool is included in the scope of delivery

Item no.	Color	Luminous flux	Color temperature	Price €
12678223	Stainless steel	670 lm	3000 K	361.10





HYBRIDE LED recessed downlight, V4A, IP67

Illuminants: LED, color rendering: CRI > 80, power: 9 W, beam angle: 40°, material: Stainless steel V4A / Aluminum / Glass, delivery: including converter for connection with 230 V mains voltage, switchable and 5,000-mm connection cable

You will find hybrid floor variants on page 490.

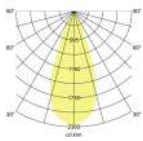

Item no.	Color	Luminous flux	Color temperature	Price €
12670223	Stainless steel	460 lm	3000 K	306.20



HYBRIDE LED recessed downlight, V4A, IP67

Illuminants: LED, color rendering: CRI > 80, power: 11 W, beam angle: 117°, material: Stainless steel V4A / Aluminum / Glass, delivery: including converter for connection with 230 V mains voltage, switchable and 5,000-mm connection cable

You will find hybrid floor variants on page 490.

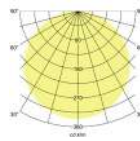

Item no.	Color	Luminous flux	Color temperature	Price €
12671223	Stainless steel	550 lm	3000 K	279.90



HYBRIDE LED recessed downlight, V4A, IP67

Illuminants: LED, color rendering: CRI > 80, power: 10 W, beam angle: 37°, material: Stainless steel V4A / Aluminum / Glass, delivery: including converter for connection with 230 V mains voltage, switchable and 5,000-mm connection cable

You will find hybrid floor variants on page 490.

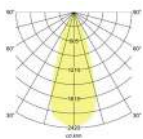

Item no.	Color	Luminous flux	Color temperature	Price €
12672223	Stainless steel	720 lm	3000 K	395.00



HYBRIDE LED recessed downlight, V4A, IP67

Illuminants: LED, color rendering: CRI > 80, power: 10 W, beam angle: 115°, material: Stainless steel V4A / Aluminum / Glass, delivery: including converter for connection with 230 V mains voltage, switchable and 5,000-mm connection cable

You will find hybrid floor variants on page 490.

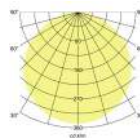

Item no.	Color	Luminous flux	Color temperature	Price €
12673223	Stainless steel	710 lm	3000 K	338.00





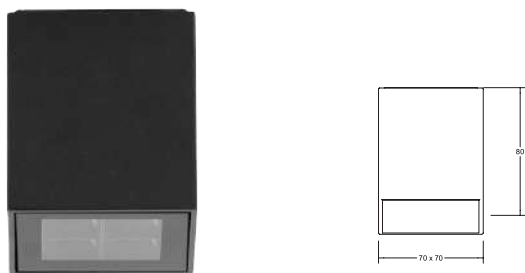

BLOKK LED ceiling-mounted luminaire, IP65

Illuminants: LED, color rendering: CRI > 80, power: 10 W, beam angle: 30°, material: Aluminum / Glass, delivery: including converter for connection with 230 V mains voltage, switchable

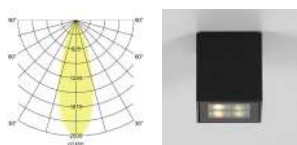

Item no.	Color	Luminous flux	Color temperature	Price €
60115103	Structural graphite	740 lm	3000 K	198.00

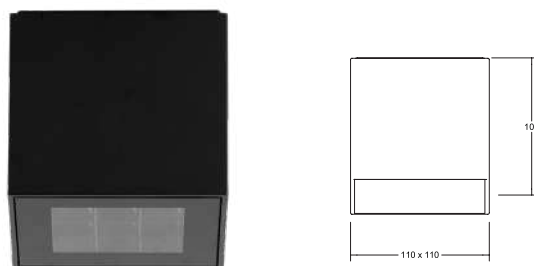
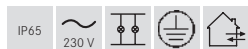

BLOKK LED ceiling-mounted luminaire, IP65

Illuminants: LED, color rendering: CRI > 80, power: 22 W, beam angle: 30°, material: Aluminum / Glass, delivery: including converter for connection with 230 V mains voltage, switchable

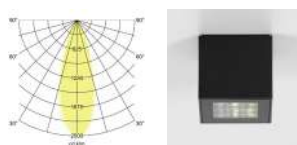

Item no.	Color	Luminous flux	Color temperature	Price €
60116103	Structural graphite	2,030 lm	3000 K	328.00

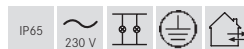

BLOKK product family



BLOKK surface-mounted spotlight

Item no.: 60111103

See page 495



BLOKK surface-mounted spotlight

Item no.: 60112103

See page 495



COOQUEE ceiling-mounted luminaire, IP65 NEW

Illuminants: For LED retrofit lamp, model: E27, power: maximum 8 W, material: Aluminum / Glass / Plastic. Illuminants are not included in the scope of delivery.

Item no.	Color	Price €
60141180	NEW Structural black	103.90

IP65
230 V

Accessories: Replacement glass 81070000 (with silicon sealing)
Price: 42.80 €

COOQUEE product family



COOQUEE wall surface-mounted luminaires
Item no.: 60140180 see page 477



COOQUEE bollard luminaire
Item no.: 60070180 see page 498





LED ceiling-mounted & wall surface-mounted luminaires, IP54

Illuminants: LED, color rendering: CRI > 80, power: 14 W, beam angle: 110°, material: Aluminum / Acrylic, delivery: including converter for connection with 230 V mains voltage, switchable

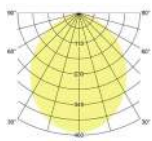

Item no.	Color	Luminous flux	Color temperature	Price €
60107183	Structural black	1,210 lm	3000 K	175.50

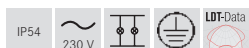

LED ceiling-mounted & wall surface-mounted luminaires, IP54

Illuminants: LED, color rendering: CRI > 80, power: 14 W, beam angle: 110°, material: Aluminum / Acrylic, delivery: including converter for connection with 230 V mains voltage, switchable

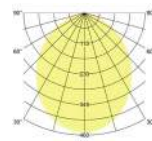

Item no.	Color	Luminous flux	Color temperature	Price €
60108183	Structural black	1,230 lm	3000 K	184.30

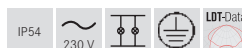

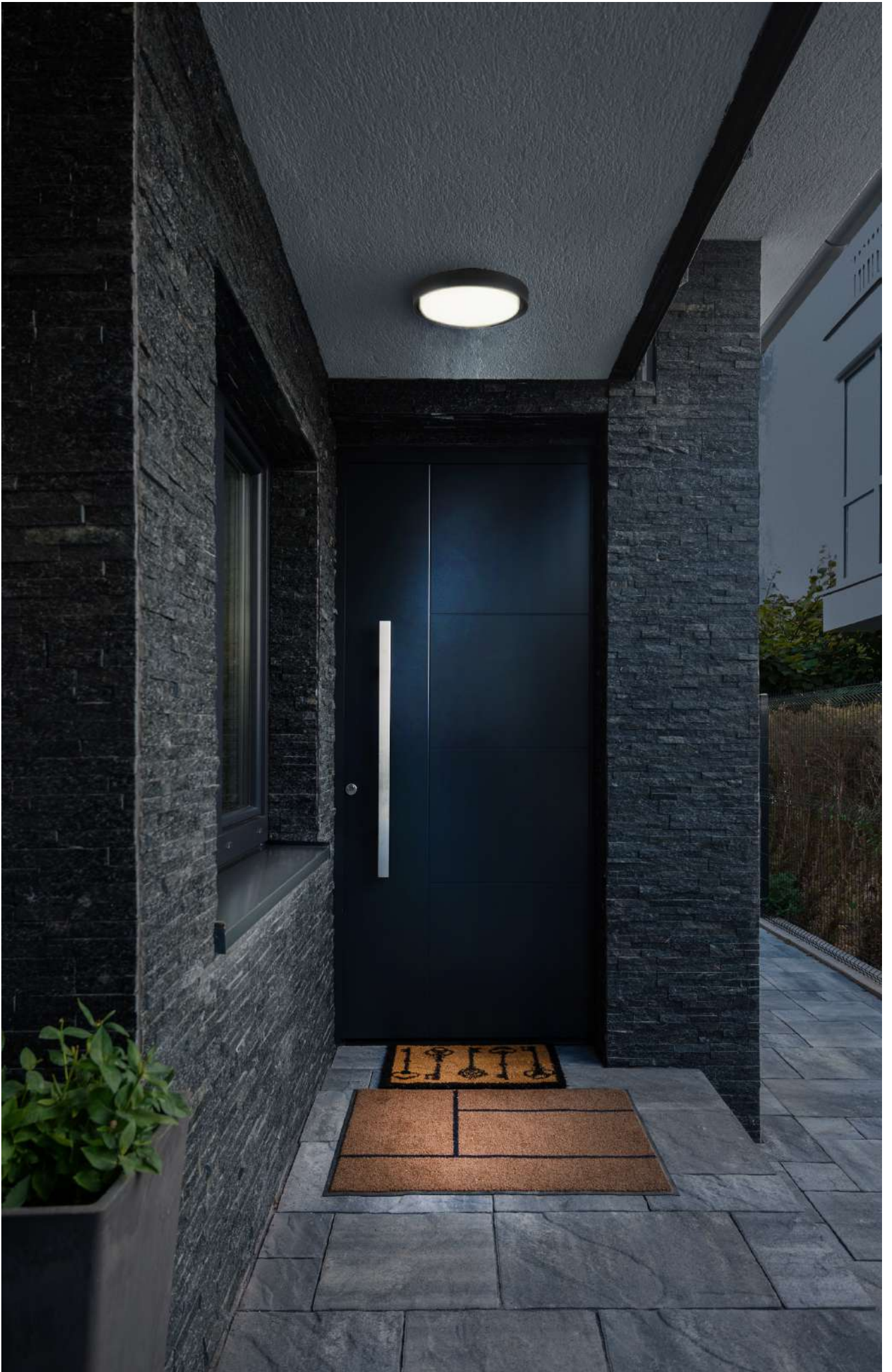

2

Exterior lighting



14

Wall-mounted luminaires.

Secure paths, stage facades,
emphasize architecture.

Wall-mounted recessed luminaire

Page 468

Wall surface-mounted luminaires

Page 470



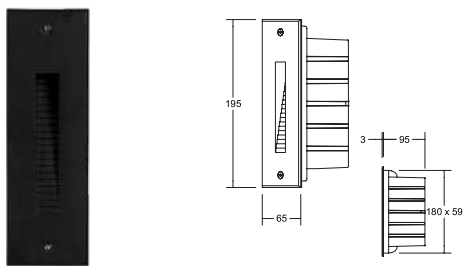

LED wall-mounted recessed luminaire, IP65

Illuminants: LED, color rendering: CRI > 80, power: 2 W, material: Aluminum / Plastic

Delivery: including converter for connection with 230 V mains voltage, switchable and wall recessed housing



Item no.	Color	Luminous flux	Color temperature	Price €
60210183	Structural black	100 lm	3000 K	146.20

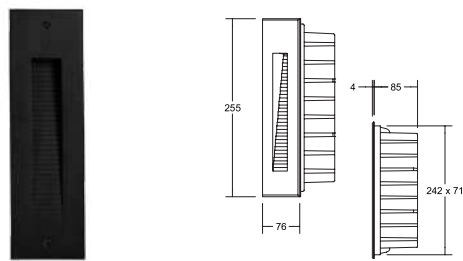

LED wall-mounted recessed luminaire, IP65

Illuminants: LED, color rendering: CRI > 80, power: 4 W, material: Aluminum / Plastic

Delivery: including converter for connection with 230 V mains voltage, switchable and wall recessed housing



Item no.	Color	Luminous flux	Color temperature	Price €
60211183	Structural black	180 lm	3000 K	196.00



Eiswiese (lee meadow), Göttingen

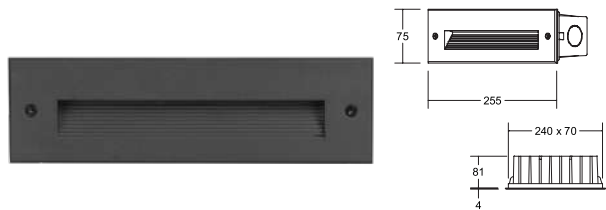

LED wall-mounted recessed luminaire, IP65

Illuminants: LED, color rendering: CRI > 80, power: 6 W, material: Aluminum / Plastic

Delivery: including converter for connection with 230 V mains voltage, switchable and wall recessed housing

Item no.	Color	Luminous flux	Color temperature	Price €
60205183	Structural black	230 lm	3000 K	197.40

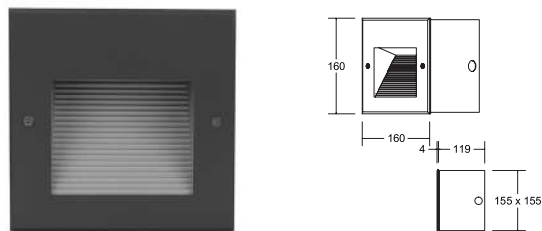

LED wall-mounted recessed luminaire, IP65

Illuminants: LED, color rendering: CRI > 80, power: 2 W, material: Aluminum / Plastic

Delivery: including converter for connection with 230 V mains voltage, switchable and wall recessed housing

Item no.	Color	Luminous flux	Color temperature	Price €
60208183	Structural black	100 lm	3000 K	175.50



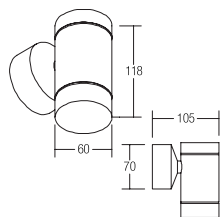

Wall surface-mounted luminaire, V4A, IP44, GU 10

Direct light emission.

Illuminants: For LED retrofit lamp, model: GU10, power: maximum 35 W, material: Stainless steel V4A / Glass

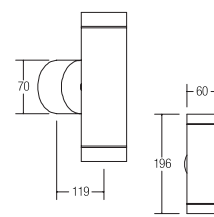

Wall surface-mounted luminaire, V4A, IP44, GU 10

Direct and indirect light emission.

Illuminants: For LED retrofit lamp, model: GU10, power: maximum 35 W each, material: Stainless steel V4A / Glass

Item no.	Color	Price €
35001420	Stainless steel	229.00

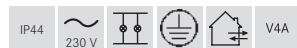

Item no.	Color	Price €
3177	Stainless steel	264.70

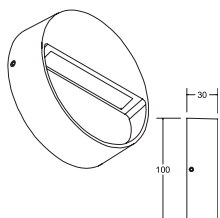
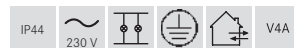

MARK LED wall surface-mounted luminaires, IP65

NEW

Illuminants: LED, color rendering: CRI > 80, power: 4 W, beam angle: 65°, material: Aluminum, delivery: including converter for connection with 230 V mains voltage, switchable

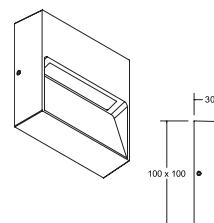

MARK LED wall surface-mounted luminaires, IP65

NEW

Illuminants: LED, color rendering: CRI > 80, power: 4 W, beam angle: 65°, material: Aluminum, delivery: including converter for connection with 230 V mains voltage, switchable

Item no.	Color	Color temperature	Price €
10170183	NEW Structural black	3000 K	92.50



Item no.	Color	Color temperature	Price €
10171183	NEW Structural black	3000 K	96.50



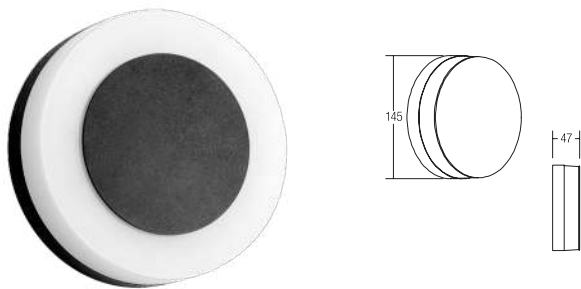

LED wall surface-mounted luminaire, IP54

With interchangeable front plate for purely indirect light distribution or direct / indirect light distribution. Both (magnetically attachable) front plates are included for customer selection.

Illuminants: LED, color rendering: CRI > 80, power: 9 W, material: Aluminum / plastic, delivery: including converter for connection with 230 V mains voltage, switchable

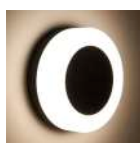

Item no.	Color	Luminous flux	Color temperature	Price €
10030173	Structural white	665 lm	3000 K	109.70
10030183	Structural black	665 lm	3000 K	109.70
10030693	Structural silver	665 lm	3000 K	109.70

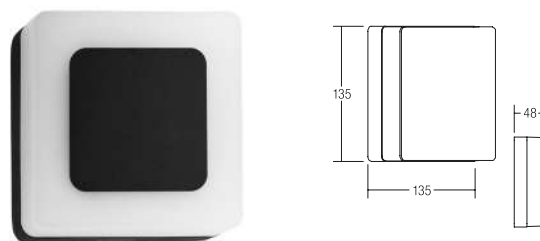

LED wall surface-mounted luminaire, IP54

With interchangeable front plate for purely indirect light distribution or direct / indirect light distribution. Both (magnetically attachable) front plates are included for customer selection.

Illuminants: LED, color rendering: CRI > 80, power: 9 W, material: Aluminum / plastic, delivery: including converter for connection with 230 V mains voltage, switchable



Item no.	Color	Luminous flux	Color temperature	Price €
10034173	Structural white	665 lm	3000 K	117.40
10034183	Structural black	665 lm	3000 K	117.40
10034693	Structural silver	665 lm	3000 K	117.40

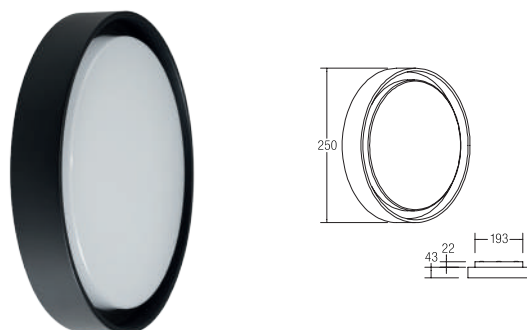

LED wall-mounted & ceiling-mounted luminaires, IP54

Illuminants: LED, color rendering: CRI > 80, power: 14 W, beam angle: 110°, material: Aluminum / Acrylic, delivery: including converter for connection with 230 V mains voltage, switchable

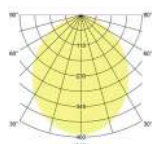

Item no.	Color	Luminous flux	Color temperature	Price €
60107183	Structural black	1,210 lm	3000 K	175.50

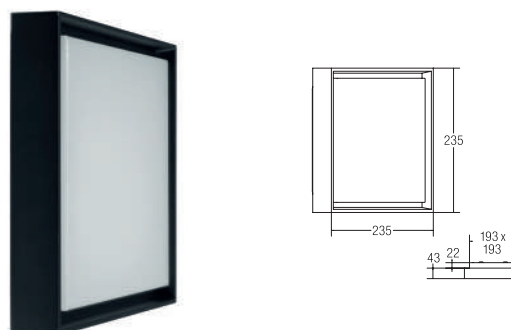

LED wall-mounted & ceiling-mounted luminaires, IP54

Illuminants: LED, color rendering: CRI > 80, power: 14 W, beam angle: 110°, material: Aluminum / Acrylic, delivery: including converter for connection with 230 V mains voltage, switchable

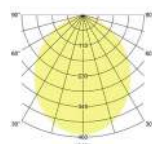

Item no.	Color	Luminous flux	Color temperature	Price €
60108183	Structural black	1,230 lm	3000 K	184.30



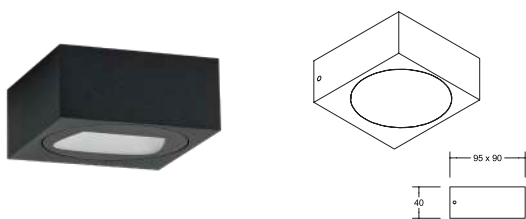

**LED wall surface-mounted luminaire
QUADER, IP65, direct**

Illuminants: LED, power: 5 W, material: Aluminum / Glass, delivery: including converter for connection with 230 V mains voltage, switchable

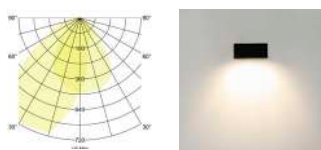

Item no.	Color	Luminous flux	Color temperature	Price €
10120103	Structural graphite	310 lm	3000 K	125.00

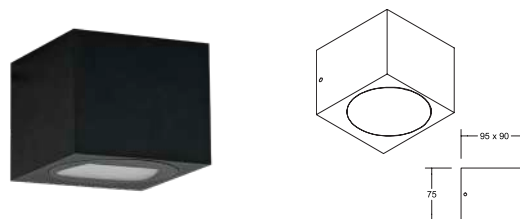
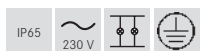

**LED wall surface-mounted luminaire
QUADER, IP65, direct/indirect**

Illuminants: LED, power: 2 x 4 W, luminous flux: 2 x 310 lm, material: Aluminum / Glass, delivery: including converter for connection with 230 V mains voltage, switchable

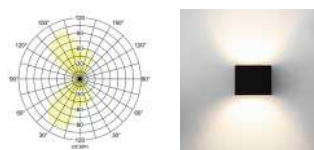

Item no.	Color	Luminous flux	Color temperature	Price €
10121103	Structural graphite	620 lm	3000 K	195.00



QUADER product family



Bollard luminaire
Item no. 60120103

See page 498

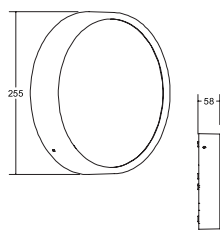

EYE LED wall surface-mounted luminaires, IP65

The Color temperature can be adjusted on site from 3000 K to 4000 K or 5700 K.

Illuminants: LED, color rendering: CRI > 80, power: 12 W, beam angle: 110°, material: Aluminum / plastic, delivery: including converter for connection with 230 V mains voltage, switchable

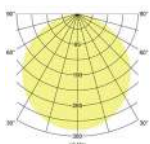

Item no.	Color	Luminous flux	Color temperature	Price €
10036183	Structural black	1,000 lm	3000 K	111.00



Luminous flux specification for color temperature 3000 K.

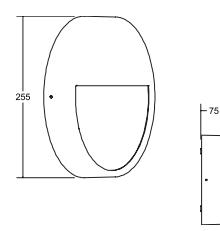

EYE LED wall surface-mounted luminaires, IP65

The Color temperature can be adjusted on site from 3000 K to 4000 K or 5700 K.

Illuminants: LED, color rendering: CRI > 80, power: 12 W, beam angle: 110°, material: Aluminum / plastic, delivery: including converter for connection with 230 V mains voltage, switchable

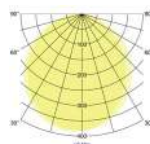

Item no.	Color	Luminous flux	Color temperature	Price €
10037183	Structural black	880 lm	3000 K	121.50



Luminous flux specification for color temperature 3000 K.



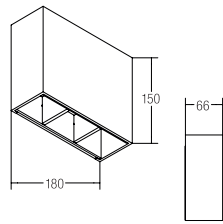

LED wall surface-mounted luminaire, IP54

Direct and indirect light emission. Wall surface-mounted luminaire with screwless pushed-over external housing. Two flaps each on the upper and lower side for variably adjustable light emission of the respective light cone.

Beam angle 2 x maximum 100°.

Illuminants: LED, color rendering: CRI > 80, power: 2 x 3 W, beam angle: 100°, luminous flux: 2 x 75 lm, material: Aluminum / Glass, delivery: including converter for connection with 230 V mains voltage, switchable

Item no.	Color	Luminous flux	Color temperature	Price €
60110103	Structural graphite	150 lm	3000 K	240.40

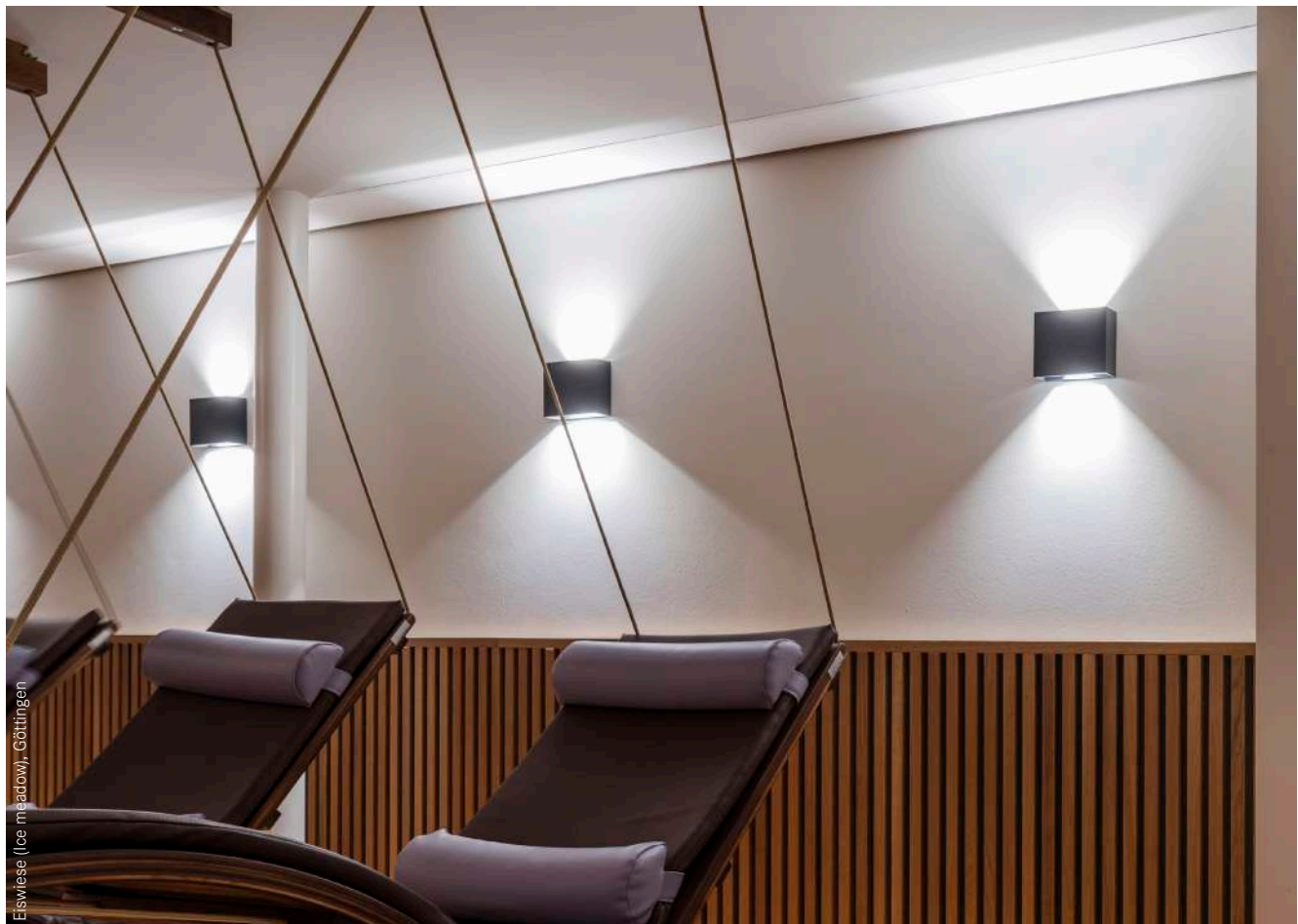
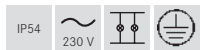

Eiswiese (see meadow), Göttingen

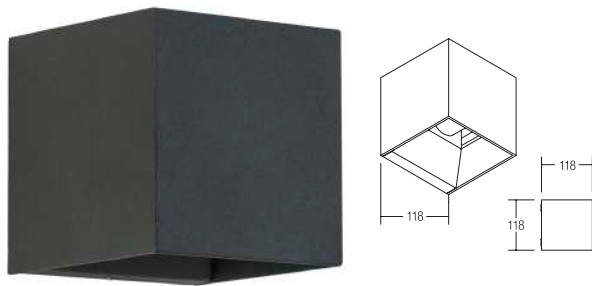

LED wall surface-mounted luminaire, IP54

Direct and indirect light emission (a centrally positioned light source).

Illuminants: LED, color rendering: CRI > 80, power: 10 W, material: Aluminum / Acrylic, delivery: including converter for connection with 230 V mains voltage, switchable



Item no.	Color	Luminous flux	Color temperature	Price €
60025183	Structural black	800 lm	3000 K	159.90

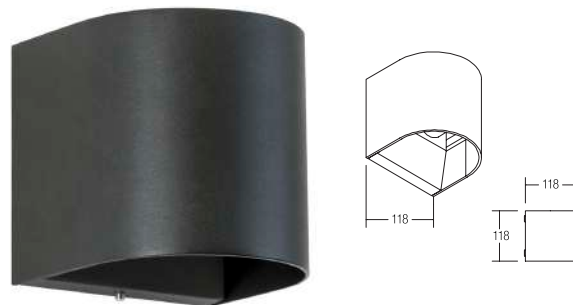

LED wall surface-mounted luminaire, IP54

Direct and indirect light emission (a centrally positioned light source).

Illuminants: LED, color rendering: CRI > 80, power: 10 W, material: Aluminum / Acrylic, delivery: including converter for connection with 230 V mains voltage, switchable



Item no.	Color	Luminous flux	Color temperature	Price €
60026183	Structural black	800 lm	3000 K	159.90

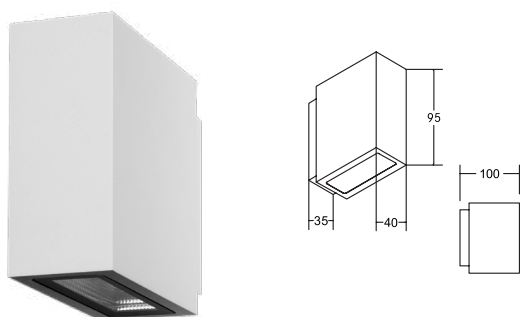

LED wall surface-mounted luminaire, IP54

Direct and indirect light emission.

Illuminants: LED, color rendering: CRI > 80, power: 2 x 3 W, beam angle: 60°, luminous flux: 2 x 225 lm, material: Aluminum / Glass, delivery: including converter for connection with 230 V mains voltage, switchable

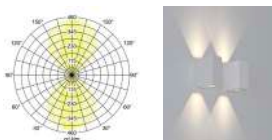

Item no.	Color	Luminous flux	Color temperature	Price €
10013103	Structural graphite	450 lm	3000 K	278.40
10013173	Structural white	450 lm	3000 K	278.40

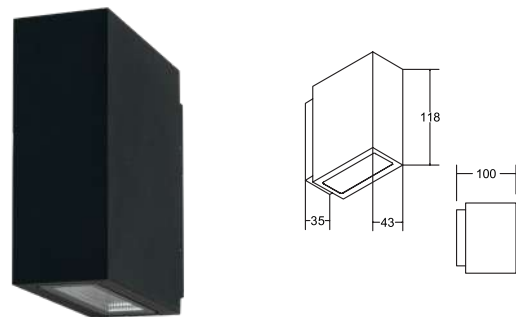
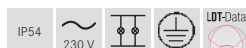

LED wall surface-mounted luminaire, IP54

Direct and indirect light emission.

Illuminants: LED, color rendering: CRI > 80, power: 2 x 5 W, beam angle: 60°, luminous flux: 2 x 325 lm, material: Aluminum / Glass, delivery: including converter for connection with 230 V mains voltage, switchable

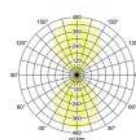

Item no.	Color	Luminous flux	Color temperature	Price €
10033103	Structural graphite	650 lm	3000 K	299.60
10033173	Structural white	650 lm	3000 K	299.60

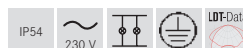

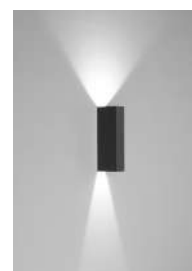
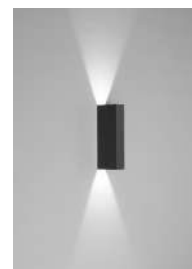
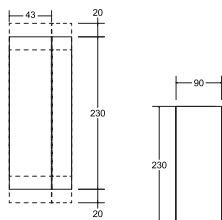
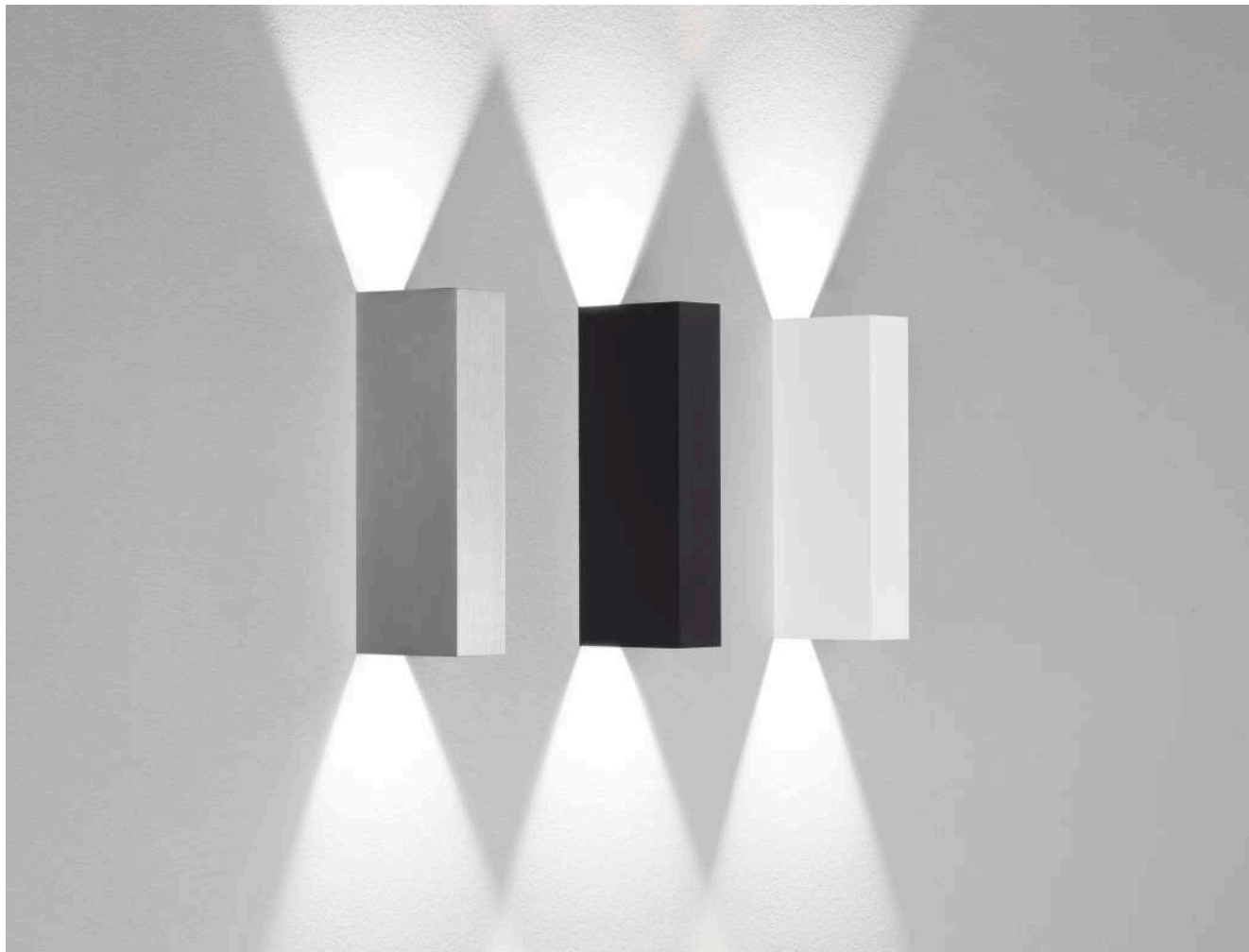

CLIQ LED wall surface-mounted luminaire, IP65 NEW

Direct and indirect light emission. Three-stage height-adjustable shield for setting different light emissions.

Illuminants: LED, color rendering: CRI > 90, power: 2 x 4.6 W, luminous flux: 2 x 190 lm, material: Aluminum / Glass, delivery: including converter for connection with 230 V mains voltage, switchable

Item no.	Color	Luminous flux	Color temperature	Price €
60127173	NEW Structural white	380 lm	3000 K	136.80
60127183	NEW Structural black	380 lm	3000 K	136.80
60127253	NEW Aluminum matte	380 lm	3000 K	143.10



* It must be mounted on a leveled surface.



COOQUEE wall surface-mounted luminaire, IP65 NEW

Illuminants: For LED retrofit lamp, model: E27, power: maximum 8 W, material: Aluminum / Glass / Plastic Illuminants are not included in the scope of delivery.



Item no.	Color	Price €
60140180	NEW Structural black	132.50

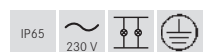

Accessories: Replacement glass 81070000 (with silicon sealing)
Price in €: 42.80

COOQUEE product family



Ceiling-mounted luminaire

Item no.: 60141180

see page 462



Bollard luminaire

Item no.: 60070180

see page 498

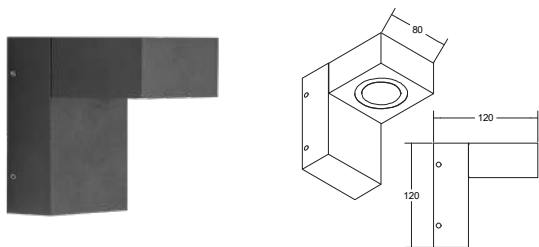

LANTERN LED wall surface-mounted luminaires, IP65

NEW

Direct light emission.

Illuminants: LED, color rendering: CRI > 90, power: 9 W, material: Aluminum / plastic, delivery: including converter for connection with 230 V mains voltage, switchable



Item no.	Color	Luminous flux	Color temperature	Price €
10106103	NEW Structural graphite	520 lm	3000 K	180.10



LANTERN product family



Bollard luminaire

Item no.: 60006103, Height 600 mm

see page 499

Item no.: 60036103, height 800 mm

See page 499

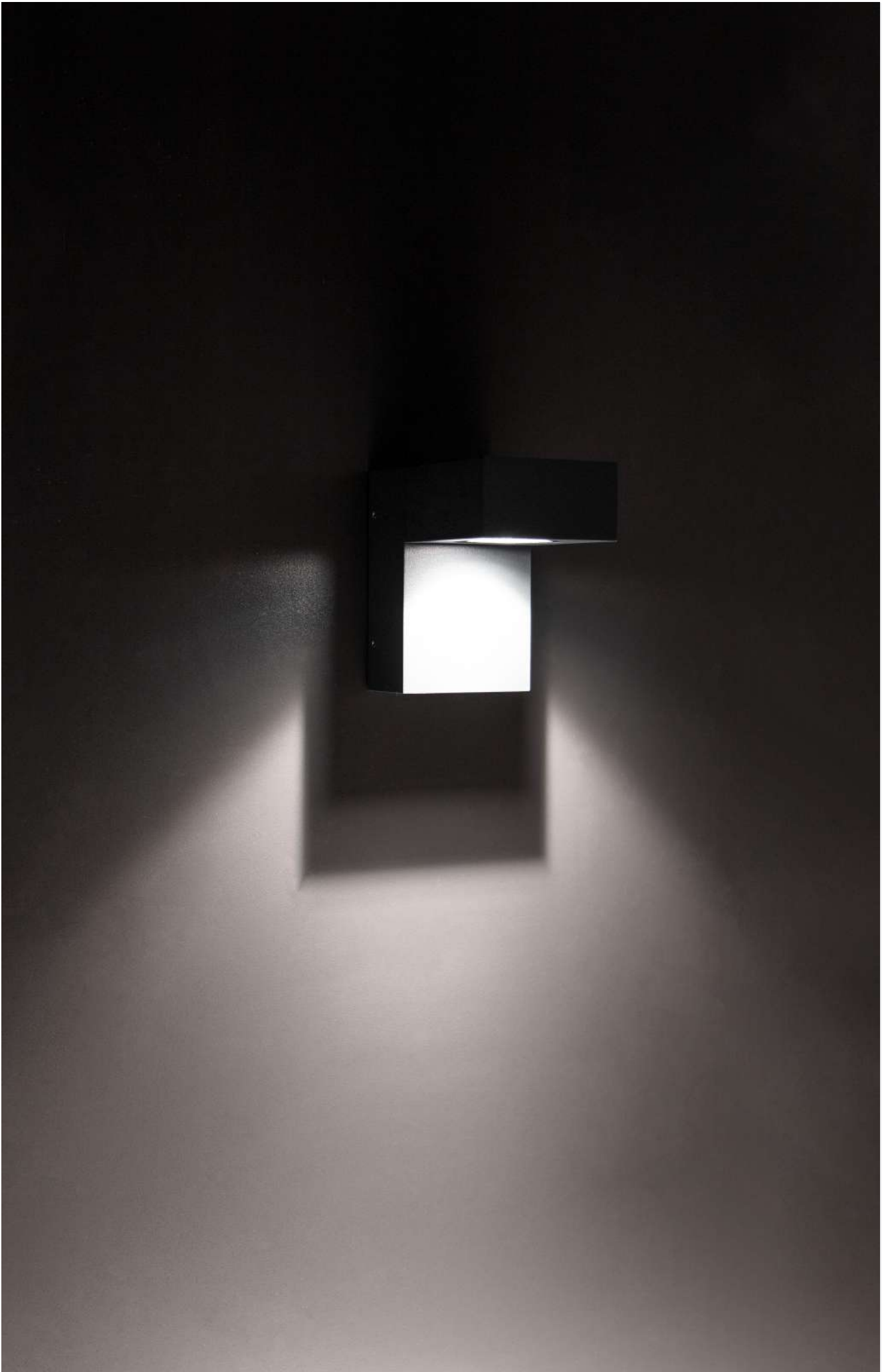

2

Exterior lighting



15
Floor luminaires.
Impressive lighting accents.

Recessed luminaires

Page 483

Ground spike luminaires

Page 492

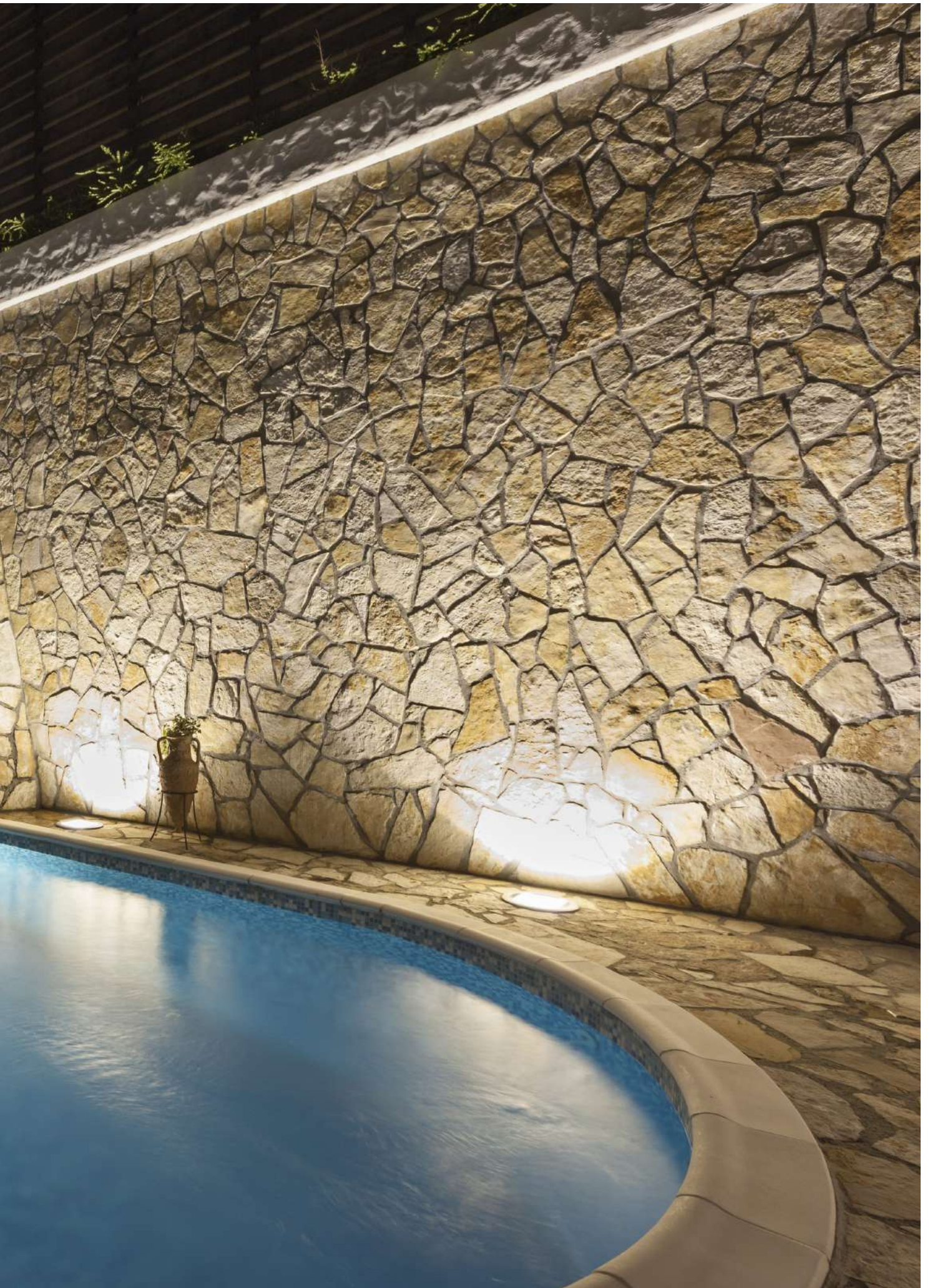

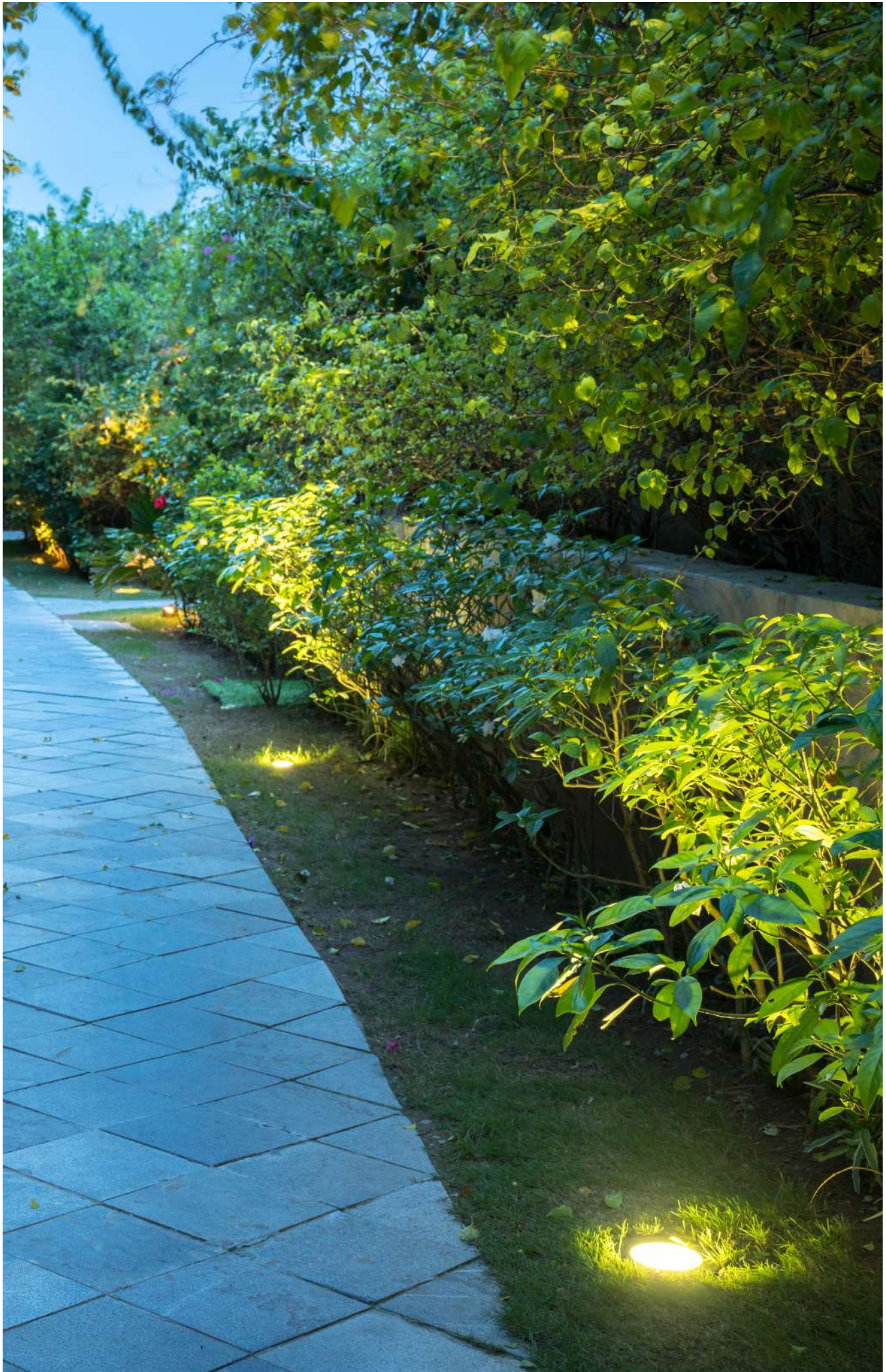

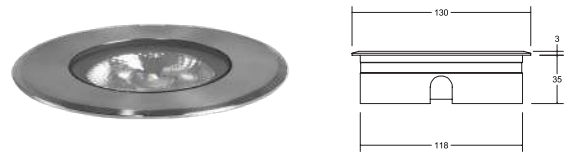
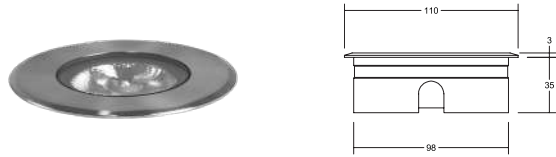

HYBRIDE FLAT LED ground recessed luminaires, V4A, IP67

Illuminants: LED, color rendering: CRI > 80, power: 6 W, beam angle: 20°, material: Stainless steel V4A / Aluminum / Glass, delivery: including 1,000 mm connection cable with aquastop and ceiling mounting springs

Hybride Flat can be delivered exclusively in the switchable model.

You will find corresponding 24 V power supplies from page 532 onwards.

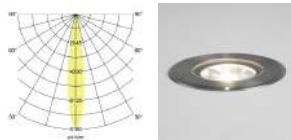

Item no.	Color	Luminous flux	Color temperature	Price €
14037223	Stainless steel	420 lm	3000 K	158.80

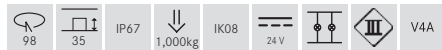

HYBRIDE FLAT LED ground recessed luminaires, V4A, IP67

Illuminants: LED, color rendering: CRI > 80, power: 9 W, beam angle: 30°, material: Stainless steel V4A / Aluminum / Glass, delivery: including 1,000 mm connection cable with aquastop and ceiling mounting springs

Hybride Flat can be delivered exclusively in the switchable model.

You will find corresponding 24 V power supplies from page 532 onwards.

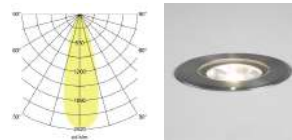

Item no.	Color	Luminous flux	Color temperature	Price €
14035223	Stainless steel	450 lm	3000 K	190.00

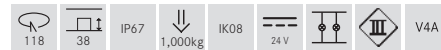

HYBRIDE FLAT LED ground recessed luminaires, V4A, IP67

Illuminants: LED, color rendering: CRI > 80, power: 12 W, beam angle: 30°, material: Stainless steel V4A / Aluminum / Glass, delivery: including 1,000 mm connection cable with aquastop and ceiling mounting springs

Hybride Flat can be delivered exclusively in the switchable model.

You will find corresponding 24 V power supplies from page 532 onwards.

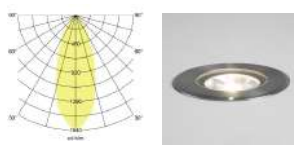

Item no.	Color	Luminous flux	Color temperature	Price €
14036223	Stainless steel	890 lm	3000 K	251.00



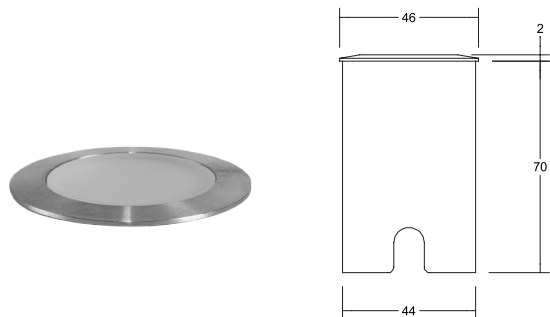

LED ground recessed luminaires HYBRIDE MINI, V4A, IP65

Illuminants: LED, color rendering: CRI > 80, power: 1.4 W, beam angle: 100°, material: Stainless steel V4A / Aluminum / Glass, delivery: including 3,000 mm connection cable

You will find corresponding 24 V power supplies from page 532 onwards.



Item no.	Color	Color temperature	Price €
14050223	Stainless steel	3000 K	108.50

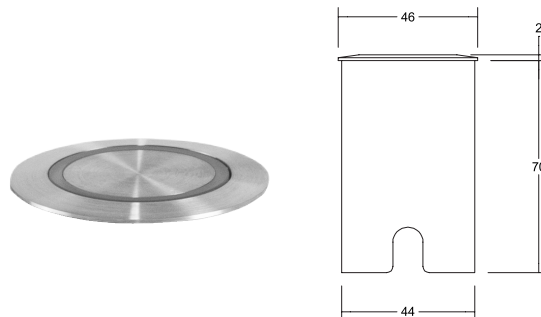

LED ground recessed luminaires HYBRIDE MINI, V4A, IP65

Illuminants: LED, color rendering: CRI > 80, power: 1.4 W, beam angle: 100°, material: Stainless steel V4A / Aluminum / Glass, delivery: including 3,000-mm connection cable

You will find corresponding 24 V power supplies from page 532 onwards.



Item no.	Color	Color temperature	Price €
14051223	Stainless steel	3000 K	118.50

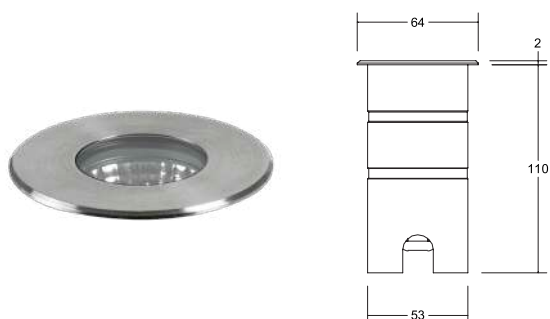

BOLED LED ground recessed luminaires, V4A, IP67

Illuminants: LED, color rendering: CRI > 80, power: 6 W, beam angle: 36°, material: Stainless steel V4A / Aluminum / Glass, Delivery: including converter for connection with 230 V mains voltage, switchable, delivery: including 1,000 mm connection cable with aquastop

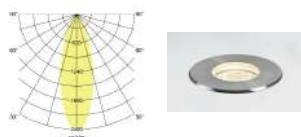

Item no.	Color	Luminous flux	Color temperature	Price €
14052223	Stainless steel	485 lm	3000 K	185.00



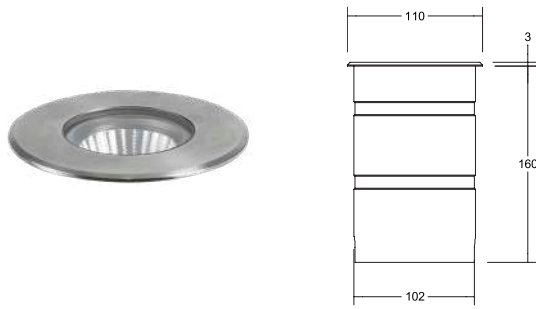

BOLED LED ground recessed luminaires, V4A, IP67

Illuminants: LED, color rendering: CRI > 80, power: 12 W, beam angle: 38°, material: Stainless steel V4A / Aluminum / Glass, delivery: including converter for connection with 230 V mains voltage, switchable, delivery: including 1,000 mm connection cable with aquastop

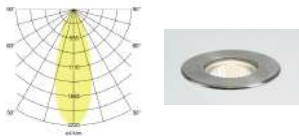

Item no.	Color	Luminous flux	Color temperature	Price €
14053223	Stainless steel	1,050 lm	3000 K	269.00

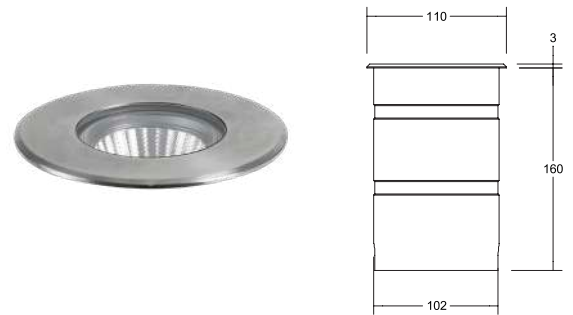

BOLED LED ground recessed luminaires, V4A, IP67

Illuminants: LED, color rendering: CRI > 80, power: 15 W, beam angle: 38°, material: Stainless steel V4A / Aluminum / Glass, delivery: including converter for connection with 230 V mains voltage, switchable, delivery: including 1,000 mm connection cable with aquastop

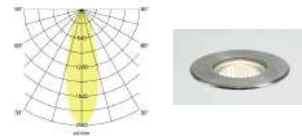

Item no.	Color	Luminous flux	Color temperature	Price €
14054223	Stainless steel	1,320 lm	3000 K	279.00

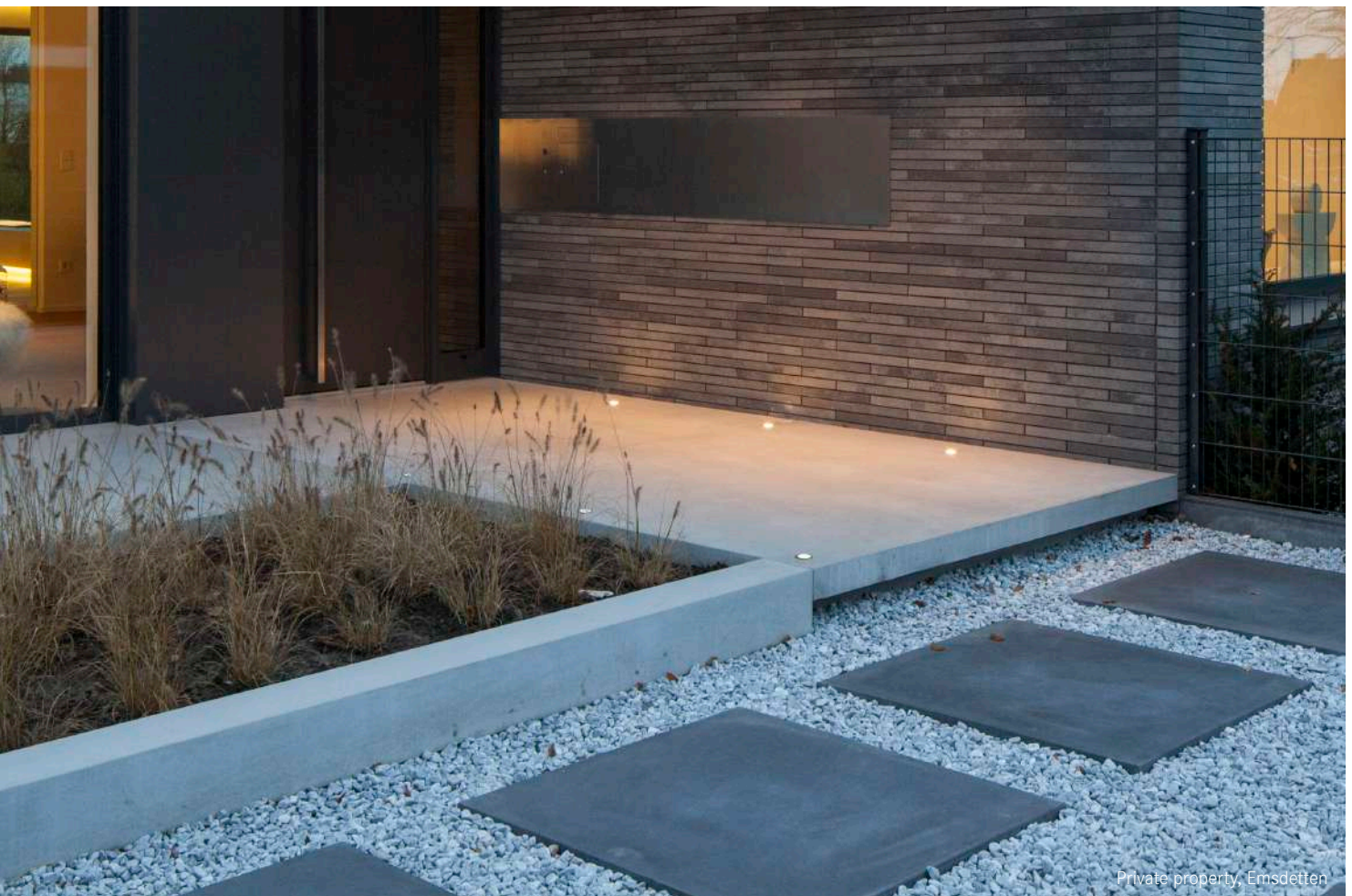

Private property, Emsdetten



LED ground recessed luminaires, IP67

Illuminants: LED, color rendering: CRI > 80, power: 0.15 W, material: Stainless steel / Aluminum / Glass, delivery: including 5,000-mm connection cable

You will find corresponding 12 V power supplies from page 530 onwards.

LED ground recessed luminaires, IP65

Including mounting sleeve and 150-mm connection cable.

Illuminants: LED, model: Plug&Play, power: 1 W, material: Stainless steel / Aluminum / Plastic / Glass

You will find the corresponding 350-mA converters from page 516 onwards.



Item no.	Color	Color temperature	Price €
14011223	Stainless steel	3000 K	50.40

Item no.	Color	Luminous flux	Color temperature	Price €
P3817WW	Stainless steel	40 lm	3000 K	126.70

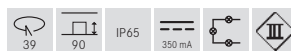
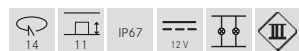

LED ground recessed luminaires, IP65

Illuminants: LED, color rendering: CRI > 80, power: 5 W, beam angle: 38°, material: Stainless steel / Aluminum / Glass, delivery: including converter for connection with 230 V mains voltage, switchable, 2 x M16 screw joints for through-wiring and mounting sleeve

LED ground recessed luminaires, IP65

Illuminants: LED, color rendering: CRI > 80, power: 5 W, beam angle: 38°, material: Stainless steel / Aluminum / Glass, delivery: including converter for connection with 230 V mains voltage, switchable, 2 x M16 screw joints for through-wiring and mounting sleeve

Item no.	Color	Luminous flux	Color temperature	Price €
14116223	Stainless steel	480 lm	3000 K	335.00

Item no.	Color	Luminous flux	Color temperature	Price €
14114223	Stainless steel	480 lm	3000 K	325.00

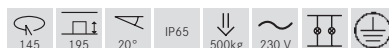
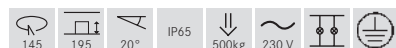

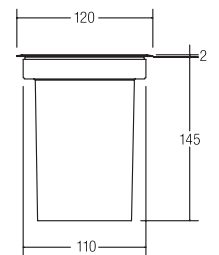

Ground recessed luminaires, IP65, GU 10

Illuminants: For LED retrofit lamp, model: GU10, power: maximum 5 W, material: Stainless steel / Glass

Suitable for Megaman LED illuminant MM 27432 / MM 26302 (not included in the scope of delivery).

Item no.	Color	Price €
3105	Stainless steel	93.10





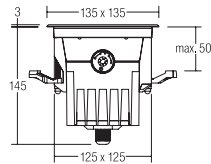

HYBRIDE LED ground recessed spotlight, V4A, IP67

Illuminants: LED, color rendering: CRI > 80, power: 2 x 5.4 W, beam angle: 30°, luminous flux: 2 x 335 lm, material: Stainless steel V4A / Aluminum / Glass, delivery: including converter for connection with 230 V mains voltage, switchable, 5,000-mm connection cable and setting tool

You will find the Hybride ceiling-mounted luminaires on pages 138 and 458.

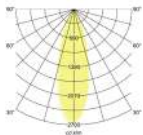

Item no.	Color	Luminous flux	Color temperature	Price €
14678223	Stainless steel	670 lm	3000 K	389.60



Two light sources can be individually set:

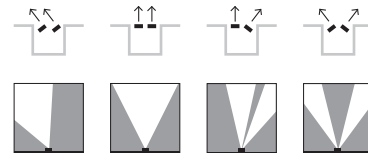

Setting tool is included in the scope of delivery

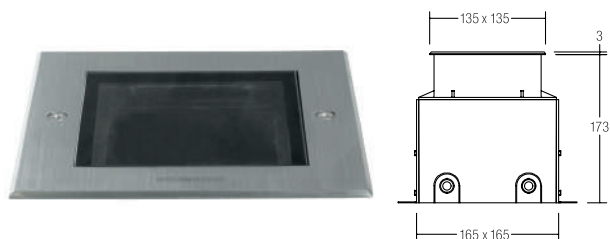

HYBRIDE LED recessed floor light, V4A, IP67

Illuminants: LED, color rendering: CRI > 80, power: 9 W, beam angle: 40°, material: Stainless steel V4A / Aluminum / Glass, delivery: including converter for connection with 230 V mains voltage, switchable, floor mounting pot and 5,000-mm connection cable

You will find the Hybride ceiling-mounted luminaires on pages 139 and 459.

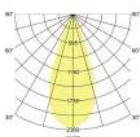

Item no.	Color	Luminous flux	Color temperature	Price €
14670223	Stainless steel	460 lm	3000 K	334.70



HYBRIDE LED recessed floor light, V4A, IP67

Illuminants: LED, color rendering: CRI > 80, power: 11 W, beam angle: 117°, material: Stainless steel V4A / Aluminum / Glass, delivery: including converter for connection with 230 V mains voltage, switchable, floor mounting pot and 5,000-mm connection cable

You will find the Hybride ceiling-mounted luminaires on pages 139 and 459.

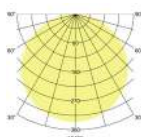

Item no.	Color	Luminous flux	Color temperature	Price €
14671223	Stainless steel	550 lm	3000 K	308.40



HYBRIDE LED recessed floor light, V4A, IP67

Illuminants: LED, color rendering: CRI > 80, power: 10 W, beam angle: 37°, material: Stainless steel V4A / Aluminum / Glass, delivery: including converter for connection with 230 V mains voltage, switchable, floor mounting pot and 5,000-mm connection cable

You will find the Hybride ceiling-mounted luminaires on pages 139 and 459.

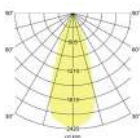

Item no.	Color	Luminous flux	Color temperature	Price €
14672223	Stainless steel	720 lm	3000 K	423.60



HYBRIDE LED recessed floor light, V4A, IP67

Illuminants: LED, color rendering: CRI > 80, power: 10 W, beam angle: 115°, material: Stainless steel V4A / Aluminum / Glass, delivery: including converter for connection with 230 V mains voltage, switchable, floor mounting pot and 5,000-mm connection cable

You will find the Hybride ceiling-mounted luminaires on pages 139 and 459.

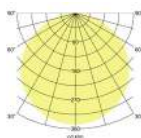

Item no.	Color	Luminous flux	Color temperature	Price €
14673223	Stainless steel	710 lm	3000 K	366.50





HYBRIDE LED recessed floor light, V4A, IP67

Illuminants: LED, color rendering: CRI > 80, power: 8 W, beam angle: 38°, material: Stainless steel V4A / Aluminum / Glass, delivery: including converter for connection with 230 V mains voltage, switchable, floor mounting pot and 5,000-mm connection cable.

You will find the Hybride ceiling-mounted luminaires on pages 137 and 457.

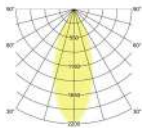

Item no.	Color	Luminous flux	Color temperature	Price €
14660223	Stainless steel	860 lm	3000 K	334.70

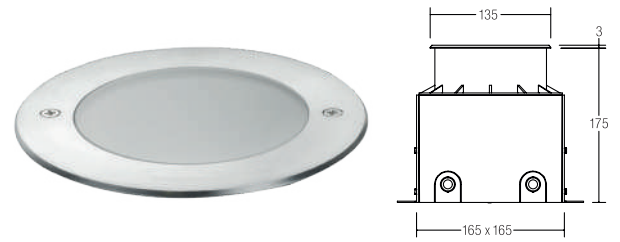

HYBRIDE LED recessed floor light, V4A, IP67

Illuminants: LED, color rendering: CRI > 80, power: 7 W, beam angle: 117°, material: Stainless steel V4A / Aluminum / Glass, delivery: including converter for connection with 230 V mains voltage, switchable, floor mounting pot and 5,000-mm connection cable.

You will find the Hybride ceiling-mounted luminaires on pages 137 and 457.

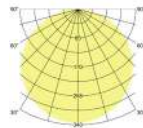

Item no.	Color	Luminous flux	Color temperature	Price €
14661223	Stainless steel	350 lm	3000 K	308.40



HYBRIDE LED recessed floor light, V4A, IP67

Illuminants: LED, color rendering: CRI > 80, power: 13 W, beam angle: 40°, material: Stainless steel V4A / Aluminum / Glass, delivery: including converter for connection with 230 V mains voltage, switchable, floor mounting pot and 5,000-mm connection cable.

You will find the Hybride ceiling-mounted luminaires on pages 137 and 457.

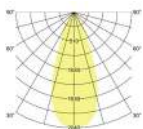

Item no.	Color	Luminous flux	Color temperature	Price €
14662223	Stainless steel	1,400 lm	3000 K	407.10



HYBRIDE LED recessed floor light, V4A, IP67

Illuminants: LED, color rendering: CRI > 80, power: 17 W, beam angle: 34°, material: Stainless steel V4A / Aluminum / Glass, delivery: including converter for connection with 230 V mains voltage, switchable, floor mounting pot and 5,000-mm connection cable.

You will find the Hybride ceiling-mounted luminaires on pages 137 and 457.

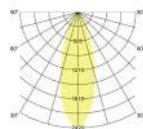

Item no.	Color	Luminous flux	Color temperature	Price €
14664223	Stainless steel	2,010 lm	3000 K	478.40



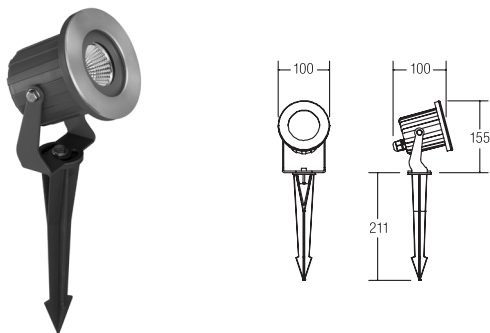

LED ground spike spotlight, 230 V AC, IP65

Illuminants: LED, color rendering: CRI > 80, power: 6 W, beam angle: 40°, material: Aluminum / Glass, delivery: including converter for connection with 230 V mains voltage, switchable, 2,000-mm connection cable and plug

Item no.	Color	Luminous flux	Color temperature	Price €
60103223	Structural black / stainless steel	450 lm	3000 K	189.90

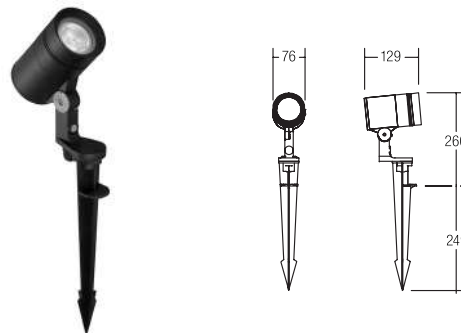

LED ground spike spotlight, 230 V AC, IP65

Illuminants: LED, color rendering: CRI > 80, power: 8 W, beam angle: 30°, material: Aluminum / Glass, delivery: including converter for connection with 230 V mains voltage, switchable, 2,000-mm connection cable and plug

Item no.	Color	Luminous flux	Color temperature	Price €
60104183	Structural black	600 lm	3000 K	259.90

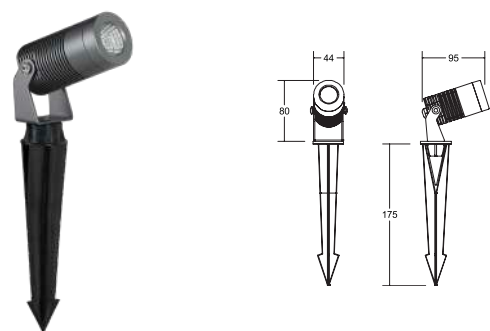

SPIKE LED ground spike spotlight, 24 V DC, IP67

Illuminants: LED, color rendering: CRI > 80, power: 8 W, beam angle: 38°, material: Aluminum / Glass, delivery: including 1,000 mm connection cable with aquastop

You will find corresponding 24 V power supplies from page 532 onwards.

Item no.	Color	Luminous flux	Color temperature	Price €
60109643	Titanium	640 lm	3000 K	104.90

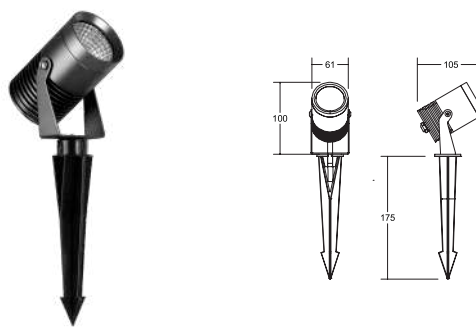

SPIKE LED ground spike spotlight, 24 V DC, IP67

Illuminants: LED, color rendering: CRI > 80, power: 15 W, beam angle: 38°, material: Aluminum / Glass, delivery: including 1,000 mm connection cable with aquastop

You will find corresponding 24 V power supplies from page 532 onwards.

Item no.	Color	Luminous flux	Color temperature	Price €
60105643	Titanium	1,200 lm	3000 K	148.30



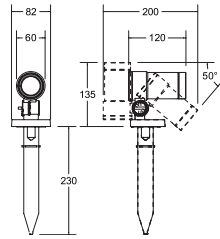

LED ground spike spotlight, 230 V AC, IP66

NEW

Illuminants: LED, color rendering: CRI > 80, power: 7.4 W, material: Aluminum / Glass, delivery: including converter for connection with 230 V mains voltage, switchable, 2,000-mm connection cable and plug

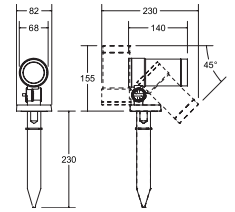

LED ground spike spotlight, 230 V AC, IP66

NEW

Illuminants: LED, color rendering: CRI > 80, power: 12.3 W, material: Aluminum / Glass, delivery: including converter for connection with 230 V mains voltage, switchable, 2,000-mm connection cable and plug

Item no.	Color	Luminous flux	Color temperature	Price €
60117183	NEW Structural black	660 lm	3000 K	179.00



Item no.	Color	Luminous flux	Color temperature	Price €
60118183	NEW Structural black	1,300 lm	3000 K	210.50

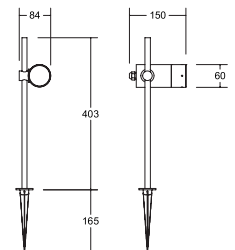

LED ground spike spotlight, 230 V AC, IP65

Illuminants: LED, color rendering: CRI > 90, power: 8.5 W, beam angle: 21°, material: Aluminum / Glass, delivery: including converter for connection with 230 V mains voltage and 1,500-mm connection cable, switchable, height-adjustable luminaire head

Item no.	Color	Luminous flux	Color temperature	Price €
60113183	Structural black	500 lm	3200 K	209.90



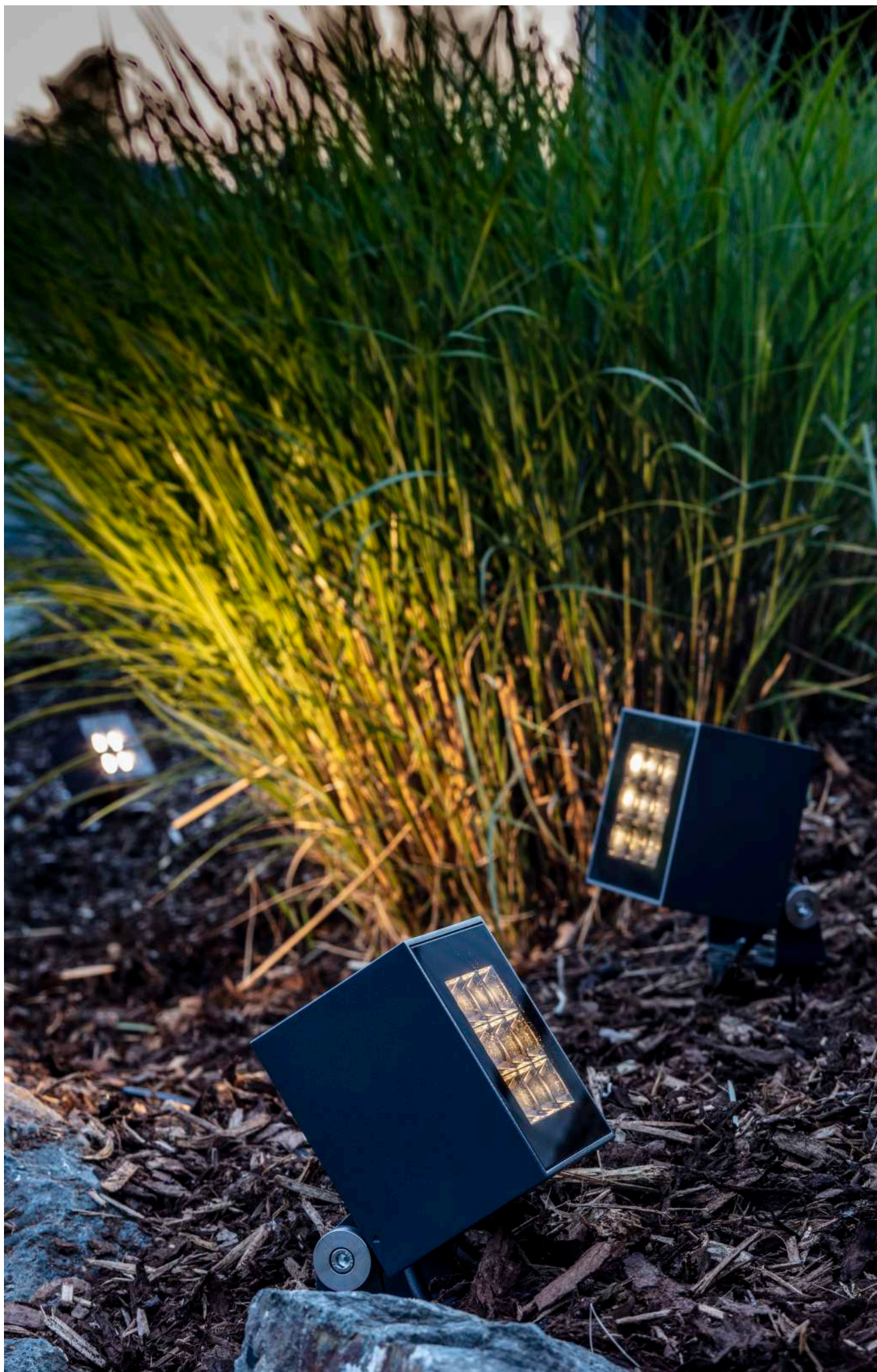

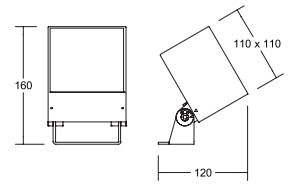
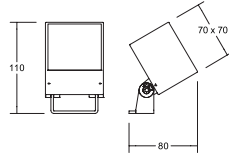

BLOKK LED surface-mounted spotlight, IP65

Illuminants: LED, color rendering: CRI > 80, power: 10 W, beam angle: 35°, material: Aluminum / Glass, delivery: including converter for connection with 230 V mains voltage, switchable, 2,000-mm connection cable

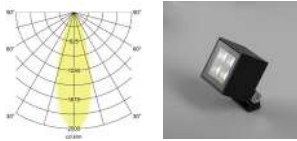

Item no.	Color	Luminous flux	Color temperature	Price €
60111103	Structural graphite	740 lm	3000 K	210.50



Optional accessory:



Ground spike
Item no. 81017000
Price in €: 6.10

BLOKK LED surface-mounted spotlight, IP65

Illuminants: LED, color rendering: CRI > 80, power: 22 W, beam angle: 36°, material: Aluminum / Glass, delivery: including converter for connection with 230 V mains voltage, switchable, 2,000-mm connection cable



Item no.	Color	Luminous flux	Color temperature	Price €
60112103	Structural graphite	1,600 lm	3000 K	359.00



Optional accessory:



Ground spike
Item no. 81021000
Price in €: 10.50



Ground anchor for concrete fixing
Item no. 81023000
Price in €: 23.50



Mounting strap, Length: 2,000 mm
Item no.: 81022000
Price in €: 61.50

BLOKK product family



BLOKK ceiling-mounted luminaire

Item no.: 601115103

See page 461

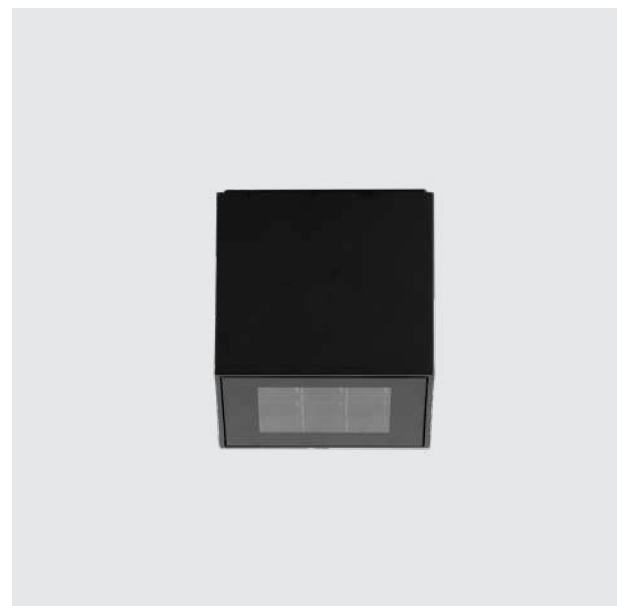

BLOKK ceiling-mounted luminaire

Item no.: 60116103

See page 461

2

Exterior lighting



16

Bollard luminaires.

Illuminate pathways, terraces and parks safely and efficiently.

Bollard luminaires

Page 498



Eiswiese (lee meadow), Göttingen

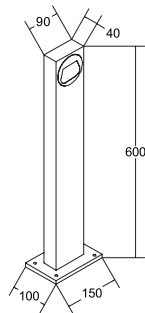

QUADER LED bollard luminaire, IP54

Base dimension: L 100 x W 150 mm

Illuminants: LED, color rendering: CRI > 90, LED power: 9 W, System power: 11 W, base dimension: L 100 x W 150 mm, material: Aluminum / Glass, delivery: including converter for connection with 230 V mains voltage, switchable and 500-mm connection cable

Item no.	Color	Luminous flux	Color temperature	Price €
60120103	Structural graphite	730 lm	3000 K	289.00



QUADER product family



Wall surface-mounted luminaire, direct

Item no.: 10120103 See page 472

Wall surface-mounted luminaire, direct/indirect

Item no.: 10121103 See page 472

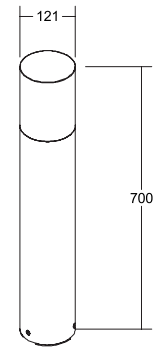

COOQUEE bollard luminaire, IP65

NEW

Illuminants: For LED retrofit lamp, model: E27, power: maximum 8 W, material: Aluminum / Glass, delivery: including converter for connection with 230 V mains voltage, illuminants are not included in the scope of delivery.



Item no.	Color	Price €
60070180	NEW Structural black	242.80



Accessories: Replacement glass 81070000 (with silicon sealing) Price in €: 42.80

COOQUEE product family



Wall surface-mounted luminaires

Item no.: 60140180 see page 462

Ceiling-mounted luminaire

Item no.: 60141180 see page 478

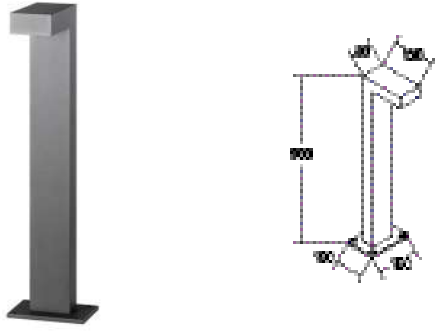

LANTERN LED bollard luminaire, IP65

NEW

Base dimension: L 100 x W 150 mm

Illuminants: LED, color rendering: CRI > 80, power: 9 W, beam angle: 71°, material: Aluminum / Glass, delivery: including converter for connection with 230 V mains voltage, switchable and 500-mm connection cable

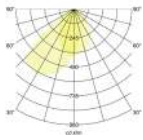

Item no.	Color	Luminous flux	Color temperature	Height	Price €
60006103	Structural graphite	520 lm	3000 K	600 mm	218.00
60036103	NEW Structural graphite	520 lm	3000 K	800 mm	295.80

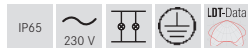

LANTERN product family



Wall surface-mounted luminaires

Item no.: 10106103

see page 478

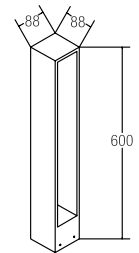

TRIAN LED bollard luminaire, IP54

Illuminants: LED, color rendering: CRI > 80, power: 9 W, material: Aluminum / Glass, delivery: including converter for connection with 230 V mains voltage, switchable

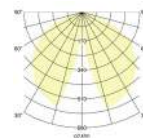

Item no.	Color	Luminous flux	Color temperature	Price €
60007103	Structural graphite	310 lm	3000 K	278.00

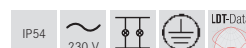

2

Exterior lighting



17

LED floodlights.

Multi-functional high-performance luminaires for outdoor installations.

LED floodlights

Page 502



MATRIX LED floodlights.

Flexible use in outdoor areas.



Key features of the products:

- More than 140 lm/W.
- Dust-proof and water-tight with IP66.
- Internal cooling pins for optimal heat dissipation and long product service life.
- Extreme temperature-resistant between -25 °C and +50 °C.
- Wall and pole mounting possible (via accessories).
- Powerful with 20 W, 50 W or 100 W.
- Corrosion-resistant die-cast aluminum housing.

IP66 designates the highest protection class against foreign bodies combined with protection against strong jets of water.

With the MATRIX LED floodlights, we are expanding our range for outdoor lighting for private, public and industrial areas. The luminaires impress with their power of 20 Watt, 50 Watt and 100 Watt and a luminous efficacy of 140 lumens per Watt. They also withstand extreme conditions between -25° Celsius and +50° Celsius and are protected against the weather with their corrosion-resistant die-cast aluminum housing. In addition, the luminaires are multi-functional - for wall mounting and installation on poles (with accessories). This makes them particularly suitable for parking lot or pathway lighting.

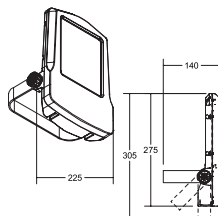

Micro
Item no. 60801...

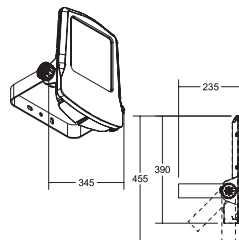

Mini
Item no. 60803...

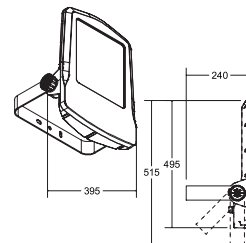

Midi
Item no. 60805...

MATRIX LED floodlights

NEW

Illuminants: LED, color rendering: CRI > 80, beam angle: 100°, material: Aluminum / Glass, delivery: including converter for connection with 230 V mains voltage, switchable, Power length: 800 mm, incl. cable connector

Pressure equalization valve on the top of the MATRIX, for pressure equalization between inside and outside the luminaire.

Symmetric light distribution

Item no.	Color	Luminous flux	Power	Color temperature	Weight	Price €
60801643	NEW Titanium matte	2.810 lm	20 W	3000 K	2.6 kg	269.90
60801644	NEW Titanium matte	2.890 lm	20 W	4000 K	2.6 kg	269.90
60803643	NEW Titanium matte	7.020 lm	50 W	3000 K	7.0 kg	459.90
60803644	NEW Titanium matte	7.240 lm	50 W	4000 K	7.0 kg	459.90
60805643	NEW Titanium matte	14,050 lm	100 W	3000 K	9.1 kg	559.90
60805644	NEW Titanium matte	14,480 lm	100 W	4000 K	9.1 kg	559.90

Asymmetric light distribution

Item no.	Color	Luminous flux	Power	Color temperature	Weight	Price €
60802643	NEW Titanium matte	3.640 lm	20 W	3000 K	2.6 kg	269.90
60802644	NEW Titanium matte	3.835 lm	20 W	4000 K	2.6 kg	269.90
60804643	NEW Titanium matte	8.036 lm	50 W	3000 K	7.0 kg	459.90
60804644	NEW Titanium matte	8.466 lm	50 W	4000 K	7.0 kg	459.90
60806643	NEW Titanium matte	13.380 lm	100 W	3000 K	9.1 kg	559.90
60805644	NEW Titanium matte	14.100 lm	100 W	4000 K	9.1 kg	559.90

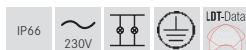

Abstrahlwinkel: 3 x 110°

These items are subject to discount group 2.

Accessories for MATRIX LED floodlights

Artikel-Nr.	Beschreibung	Preis €
81100640	NEW Extension adapter for 60801... (Micro)	99.90
81101640	NEW Extension adapter for 60803... (Mini)	99.90
81102640	NEW Extension adapter for 60805... (Midi)	99.90
81110640	NEW Protective grille for 60801... (Micro)	34.00
81111640	NEW Protective grille for 60803... (Mini)	52.00
81112640	NEW Protective grille for 60805... (Midi)	69.00

These items are subject to discount group 2.



Matching pole holder on request.

Diameter: 42 - 63 mm



3

LED modules and accessories

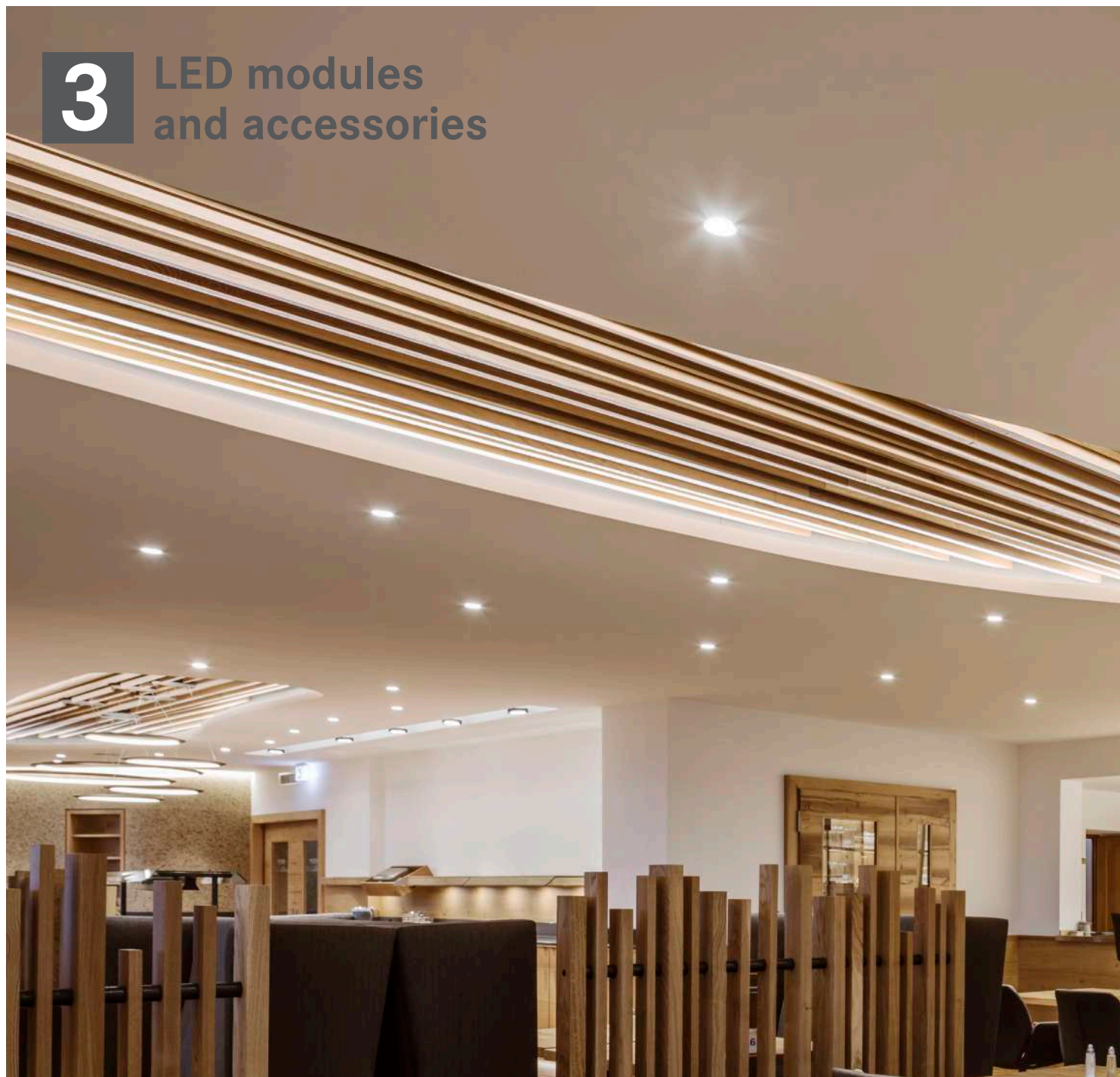

18

LED modules.

The right light for every luminaire.

MR16 LED inserts

Page 506



Hotel YDK, Bad Frideburg

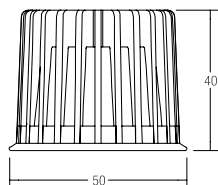

MR16 LED reflector insert, 3 W, 350 mA

Illuminants: LED, model: Plug&Play, color rendering: CRI > 80, power: 3 W, beam angle: 38°, material: Aluminum / Glass

You will find the corresponding 350-mA converters from page 516 onwards.

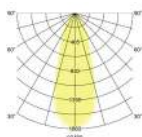

Item no.	Color temperature	Luminous flux	Beam angle	Price €
12925003	2700 K	290 lm	38°	37.90
12926003	3000 K	310 lm	38°	37.90
12925004	4000 K	340 lm	38°	37.90

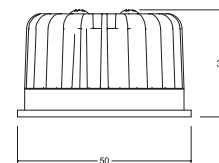

MR16 LED reflector insert, 6 W, 350 mA

NEW

Illuminants: LED, model: Plug&Play, color rendering: CRI > 80, power: 6 W, material: Aluminum / Glass

You will find the corresponding 350-mA converters from page 516 onwards.

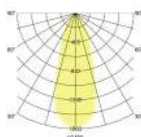

Item no.	Color temperature	Luminous flux	Beam angle	Price €
12923383	NEW 2700 K	600 lm	38°	51.80
12923603	NEW 2700 K	570 lm	60°	51.80
12924383	NEW 3000 K	680 lm	38°	51.80
12924603	NEW 3000 K	660 lm	60°	51.80
12924384	NEW 3500 K	680 lm	38°	51.80
12924604	NEW 3500 K	660 lm	60°	51.80
12923384	NEW 4000 K	720 lm	38°	51.80
12923604	NEW 4000 K	700 lm	60°	51.80



dim2warm

MR16 LED reflector insert, 6 W, dim2warm, 350 mA

If the LED module is dimmed, the color temperature reduces.

Illuminants: LED, model: Plug&Play, color rendering: CRI > 80, power: 6 W, material: Aluminum / Glass

You will find the corresponding 350-mA converters from page 516 onwards.

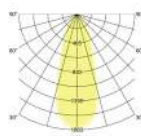

Item no.	Color temperature	Luminous flux	Beam angle	Price €
12963383	NEW 3000 K - 1800 K	460 lm	38°	61.10
12963603	NEW 3000 K - 1800 K	460 lm	60°	61.10





MR16 LED reflector insert, 12 W, 350 mA

Illuminants: LED, model: Plug&Play, color rendering: CRI > 80, power: 12 W, beam angle: 38°, material: Aluminum / Glass

You will find the corresponding 350-mA converters from page 516 onwards.

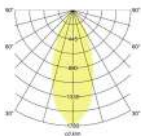

Item no.	Color temperature	Luminous flux	Beam angle	Price €
12953003	2700 K	1,120 lm	38°	84.60
12954003	3000 K	1,210 lm	38°	84.60
12954004	3500 K	1,240 lm	38°	84.60
12953004	4000 K	1,250 lm	38°	84.60



dim²warm

MR16 LED reflector insert, 12 W, dim2warm, 350 mA

If the LED module is dimmed, the color temperature reduces.

Illuminants: LED, model: Plug&Play, color rendering: CRI > 90, power: 12 W, beam angle: 38°, material: Aluminum / Glass

You will find the corresponding 350-mA converters from page 516 onwards.

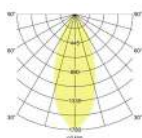

Item no.	Color temperature	Luminous flux	Beam angle	Price €
12965003	3000 K - 1800 K	930 lm	38°	97.80



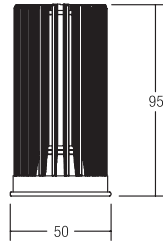

MR16 LED reflector insert, 12.5 W, SunLike, CRI > 97, 350 mA

Illuminants: LED, model: Plug&Play, **color rendering: CRI > 97**, power: 12.5 W, beam angle: 38°, material: Aluminum / Plastic

You will find the corresponding 350-mA converters from page 516 onwards.

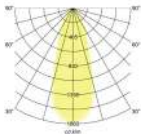

Item no.	Color temperature	Luminous flux	Beam angle	Color rendering	Price €
12983003	3000 K	920 lm	38°	CRI > 97	99.20

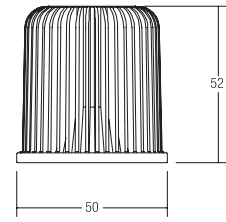

MR16 LED reflector insert, 8 W, 24 V DC

Illuminants: LED, color rendering: CRI > 90 Power: 8 W, beam angle: 60°, material: Aluminum / Glass

You will find corresponding 24 V power supplies from page 532 onwards.

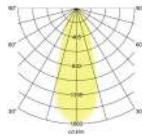

Item no.	Color temperature	Luminous flux	Beam angle	Price €
12823003	2850 K	900 lm	60°	88.00

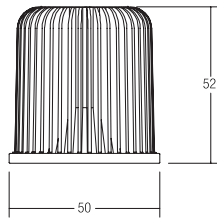

MR16 LED reflector insert, 8 W, TunableWhite, 24 VDC

Connection cable: 3-core, control unit: negative (common anode) (C. A.)

Illuminants: LED, color rendering: CRI > 90 (CW + WW), Power/Color temperature approximately 4 W (WW), 4 W (CW), 8 W (WW+CW)

Beam angle: 60°, material: Aluminum / Glass

You will find corresponding 24 V power supplies from page 532 onwards and corresponding controllers from page 536 onwards.

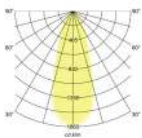

Item no.	Color temperature	Luminous flux	Beam angle	Price €
12843004	2000 K - 6500 K	700 lm*	60°	139.00



* Luminous flux: 318 lm at 2000 K, 374 lm at 4000 K, 415 lm at 6500 K

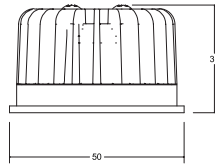

MR16 DISC LED insert, 6 W, with lens optics, 350 mA

Illuminants: LED, model: Plug&Play, color rendering: CRI > 80,
power: 6 W, material: Aluminum / Plastic

You will find the corresponding 350-mA
converters from page 516 onwards.

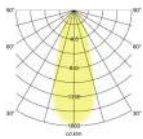

Item no.	Color temperature	Luminous flux	Beam angle	Price €
12920183	3000 K	640 lm	18°	32.30
12920243	3000 K	690 lm	24°	32.30
12920003	3000 K	670 lm	38°	32.30
12920603	3000 K	620 lm	60°	32.30
12920184	4000 K	685 lm	18°	32.30
12920244	4000 K	740 lm	24°	32.30
12920004	4000 K	720 lm	38°	32.30
12920604	4000 K	660 lm	60°	32.30



SmartLight.

Combine the luminaires and
inserts easily.

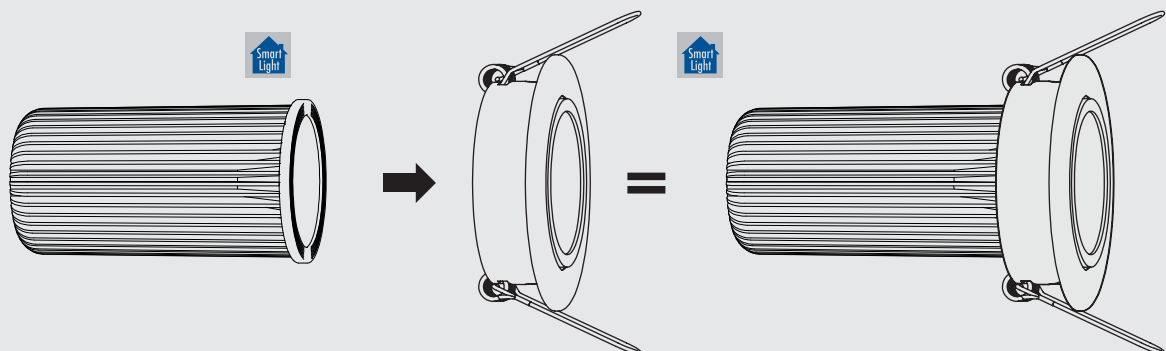

Luminaires are also
compatible with all other MR16.

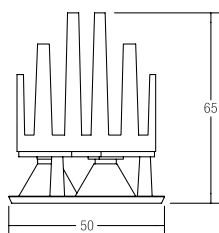

Hotel Inspire, Munich

**RGB****MR16 LED insert with lens optics,
RGB, 12 V DC**

Illuminants: LED, power: 13.8 W, beam angle: 45°,
Luminous flux: red: 65 lm / green: 135 lm / blue: 30 lm,
material: Aluminum / Plastic

You will find corresponding 12 V power supplies from page 530 onwards
and corresponding controllers from page 536 onwards.

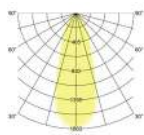

Item no.	Color temperature	Energy efficiency class	Beam angle	Price €
18101001	RGB	Special product *	45°	139.90

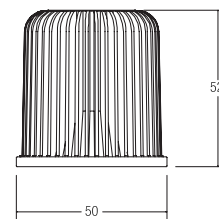

Special product * (for details, see page 596)

**dim4colour****MR16 LED reflector insert, 8 W,
dim4colour (RGB+WW), 24 V DC**

RGB+WW module, connection cable: 5-core,
Control unit: negative, common anode (C. A.)

Illuminants: LED, color rendering: CRI > 90, power: 8 W,
beam angle: 60°, luminous flux: RGB (combined) 165 lm / WW (2850 K)
235 lm, material: Aluminum / Plastic

You will find corresponding 24 V power supplies from page 532 onwards
and corresponding controllers from page 536 onwards.

Item no.	Color temperature	Beam angle	Price €
18438002	RGB+WW	60°	139.00

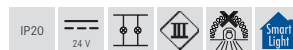

3 LED modules and accessories

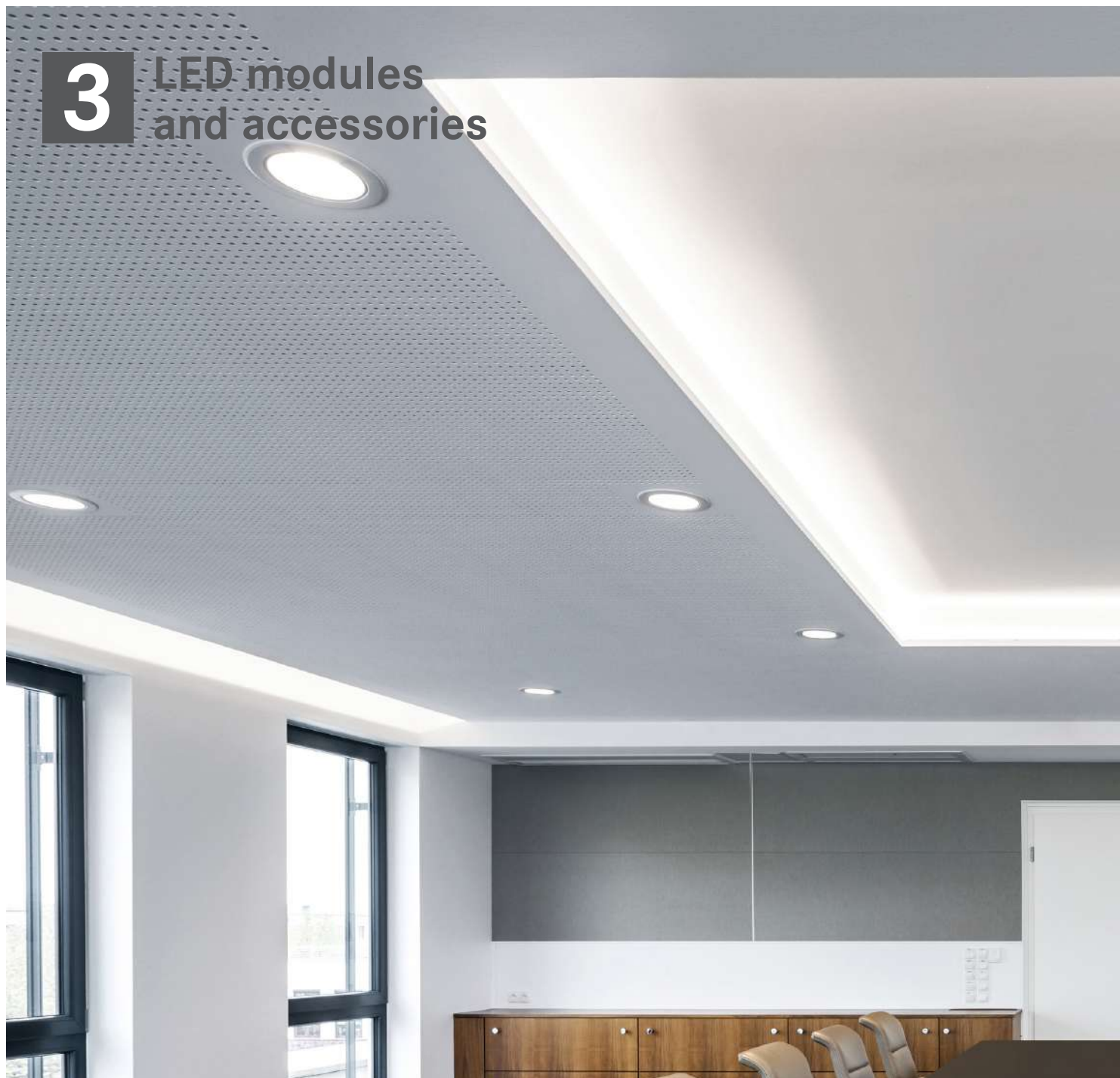

19 Operating technology.

Control illumination according to requirements – from switchable to DALI and KNX.

- Converter 350 mA
- Converter 500 mA
- Converter 700 mA
- Converter 1,000 mA

- Page 516
- Page 522
- Page 524
- Page 528

- Power supplies 12 V DC
- Power supplies 24 V DC
- Controllers

- Page 530
- Page 532
- Page 536



Private house, Hamburg

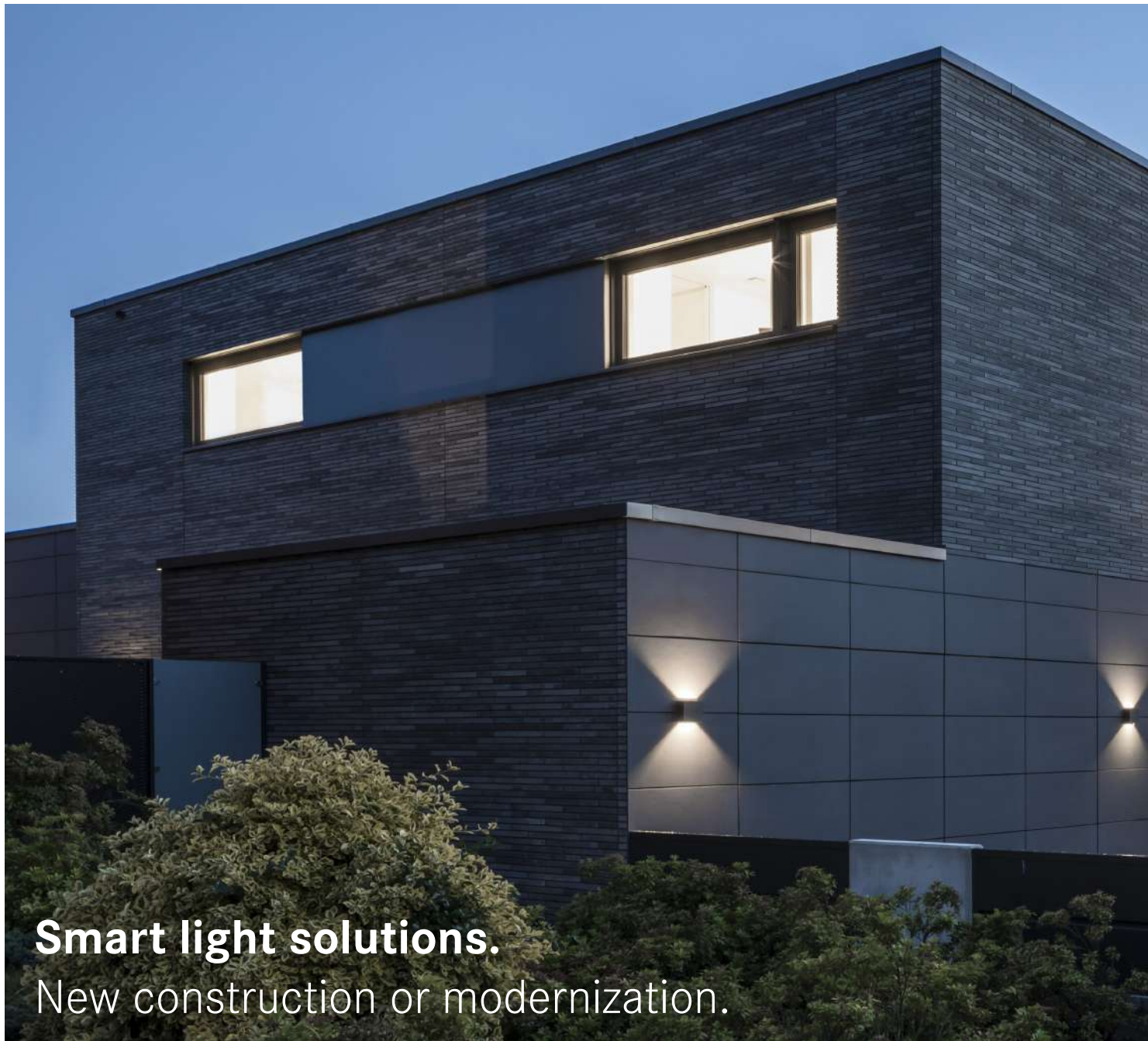

Smart light solutions.

New construction or modernization.

Always combine the pleasant with the useful for the users. Simple operation, manual intervention options in the automation system, and optimum daylighting. Intelligent building technology means convenience and safety - also when it comes to lighting.

Keeping an eye on the lighting status at all times, quickly receiving information about faults and making changes yourself with little effort. Integration into existing systems to offer users the greatest possible scope for investment and use.

This is how Brumberg's networking strategy is set up. Depending on the status, we are able to integrate our luminaires and lighting systems into the respective control systems and system worlds.





Private house, Vreden

Applications of luminaires	1 - 10 V	DALI DT6	DALI DT8	DMX	KNX	eNet	Radio	Phase	Casambi	ZigBee
1-channel LED luminaire	Yes	Yes	No	only CV	only CV	Yes	Yes	Yes	only CC	Yes
2-channel LED luminaire	Yes	Yes	Yes	Yes	Yes	Yes	Yes	No	No	only CV
3-channel LED luminaire	Yes	Yes	No	Yes	Yes	No	Yes	No	No	only CV
4-channel LED luminaire	Yes	Yes	No	Yes	Yes	No	Yes	No	No	only CV
1-channel flex board	Yes	Yes	No	Yes	Yes	Yes	Yes	No	No	Yes
2-channel flex board	Yes	Yes	Yes	Yes	Yes	Yes	Yes	No	No	Yes
3-channel flex board	Yes	Yes	No	Yes	Yes	No	Yes	No	No	Yes
4-channel flex board	Yes	Yes	No	Yes	Yes	No	Yes	No	No	Yes
5-channel flex board	No	No	No	No	No	No	Yes	No	No	Yes

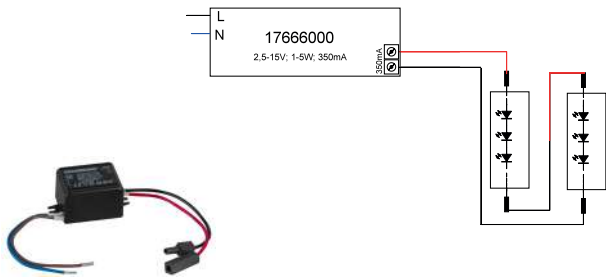

LED converter 350 mA, switchable

This converter is protected against overvoltage and short circuit as well as thermal and electrical overload using fuses. Maximum cable length on secondary side: 2,000 mm.

Dimensions: L 52 x W 30 x H 23 mm, input voltage: AC: 220-240 V, secondary-side circuit type: Series connection, control unit: switchable, ambient temperature (ta): -20 °C to +50 °C, measuring point (tc): maximum +85 °C, material: Plastic, delivery: Plug&Play model with 110 mm P&P output line

Item no.	Current	Assembly	Power	Price €
17666000	350 mA	Plug&Play	1-5 W	29.70

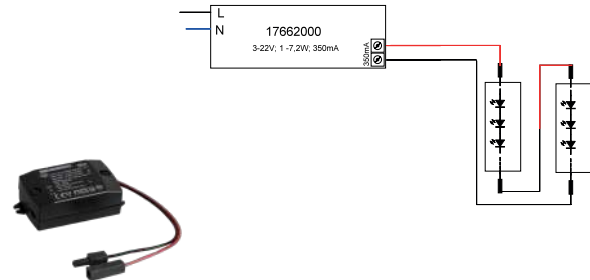

LED converter 350 mA, switchable

This converter is protected against overvoltage and short circuit as well as thermal and electrical overload using fuses. The input and output terminals are suitable for lines with a cross-section of up to 1.5 mm².

Dimensions: L 68 x W 35 x H 21 mm, input voltage: AC: 220-240 V, secondary-side circuit type: Series connection, control unit: switchable, ambient temperature (ta): -20 °C to +50 °C, measuring point (tc): maximum +75 °C, material: Plastic, delivery: Plug&Play model with 110 mm P&P output line

Item no.	Current	Assembly	Power	Price €
17662000	350 mA	Plug&Play	1-7.2 W	24.00
17662010	350 mA	without	1-7.2 W	21.80
17662020	350 mA	Plug&Play + connection box	1-7.2 W	31.80

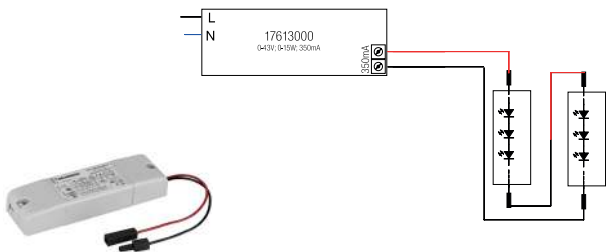

LED converter 350 mA, switchable

This operating device fulfills the requirements for safety lighting systems as per DIN EN 50172 VDE 0108-100:2005-01. This converter is protected against overvoltage and short circuit as well as thermal and electrical overload using fuses. The input and output terminals are suitable for lines with a cross-section of up to 2.5 mm².

Dimensions: L 115 x W 34 x H 19 mm, input voltage: AC: 100-240 V, DC: 176-280 V, secondary-side circuit type: Series connection, control unit: switchable, ambient temperature (ta): -25 °C to +45 °C, measuring point (tc): maximum +75 °C, material: Plastic, delivery: Plug&Play model with 110 mm P&P output line

Item no.	Current	Assembly	Power	Price €
17613000	350 mA	Plug&Play	0-15 W	41.20
17613010	350 mA	without	0-15 W	38.40
17613020	350 mA	Plug&Play + connection box	0-15 W	48.30

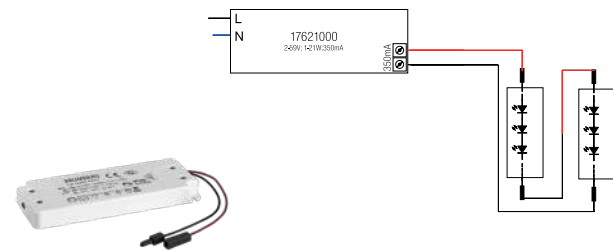

LED converter 350 mA, switchable

This converter is protected against overvoltage and short circuit as well as thermal and electrical overload using fuses. The input and output terminals are suitable for lines with a cross-section of up to 1.5 mm².

Dimensions: L 128 x W 50 x H 13 mm, input voltage: AC: 220-240 V, secondary-side circuit type: Series connection, control unit: switchable, ambient temperature (ta): -20 °C to +45 °C, measuring point (tc): maximum +85 °C, material: Plastic, delivery: Plug&Play model with 110 mm P&P output line

Item no.	Current	Assembly	Power	Price €
17621000	350 mA	Plug&Play	1-21 W	46.00
17621010	350 mA	without	1-21 W	44.40
17621020	350 mA	Plug&Play + connection box	1-21 W	54.40



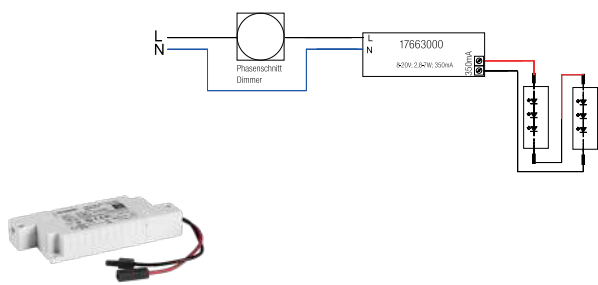

LED converter 350 mA, Dimmable phase section

This converter is protected against overvoltage and short circuit as well as thermal and electrical overload using fuses. The input and output terminals are suitable for lines with a cross-section of up to 1.5 mm².

Dimensions: L 110 x W 50 x H 19 mm, input voltage: AC: 198-264 V, secondary-side circuit type: Series connection, control unit: Phase section, ambient temperature (ta): -20 °C to +50 °C, measuring point (tc): maximum +80 °C, material: Plastic, delivery: Plug&Play model with 110 mm P&P output line

Item no.	Current	Assembly	Power	Price €
17663000	350 mA	Plug&Play	2.8-7 W	27.90
17663010	350 mA	without	2.8-7 W	25.80
17663020	350 mA	Plug&Play + connection box	2.8-7 W	35.10

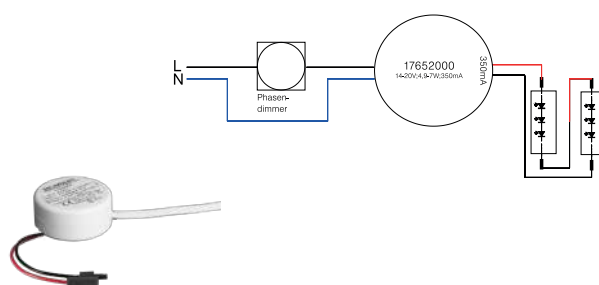

LED round converter 350 mA, Dimmable phase section

Dimensions: D 51 x H 24 mm, input voltage: AC: 220-240 V, secondary-side circuit type: Series connection, control unit: Phase section, ambient temperature (ta): -20 °C to +50 °C, measuring point (tc): maximum +85 °C, material: Plastic, delivery: Plug&Play model with 110 mm P&P output line

Item no.	Current	Assembly	Power	Price €
17652000	350 mA	Plug&Play	4.9-7 W	40.70
17652020	350 mA	Plug&Play + connection box	4.9-7 W	47.80

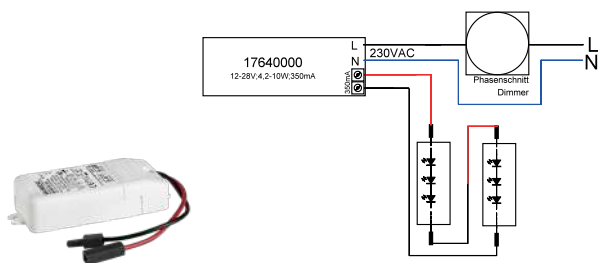

LED converter 350 mA, Dimmable phase section

This converter is protected against overvoltage and short circuit as well as thermal and electrical overload using fuses. The input and output terminals are suitable for lines with a cross-section of up to 2.5 mm².

Dimensions: L 102 x W 38 x H 21 mm, input voltage: AC: 220-240 V, secondary-side circuit type: Series connection, control unit: Phase section, ambient temperature (ta): -25 °C to +45 °C, measuring point (tc): maximum +70 °C, material: Plastic, delivery: Plug&Play model with 110 mm P&P output line

Item no.	Current	Assembly	Power	Price €
17640000	350 mA	Plug&Play	4.2-10 W	38.10
17640010	350 mA	without	4.2-10 W	36.10
17640020	350 mA	Plug&Play + connection box	4.2-10 W	44.60

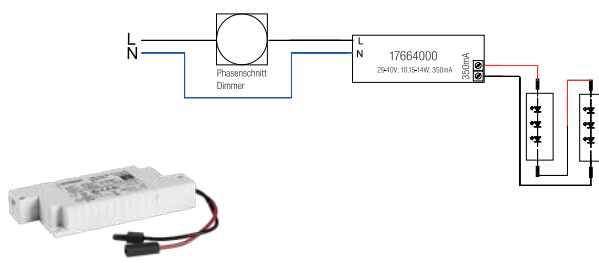

LED converter 350 mA, Dimmable phase section

This converter is protected against overvoltage and short circuit as well as thermal and electrical overload using fuses. The input and output terminals are suitable for lines with a cross-section of up to 1.5 mm².

Dimensions: L 125 x W 51 x H 20 mm, input voltage: AC: 220-240 V, secondary-side circuit type: Series connection, control unit: Phase section, ambient temperature (ta): -20 °C to +50 °C, measuring point (tc): maximum +80 °C, material: Plastic, delivery: Plug&Play model with 110 mm P&P output line

Item no.	Current	Assembly	Power	Price €
17664000	350 mA	Plug&Play	10.15-14 W	40.60
17664010	350 mA	without	10.15-14 W	38.40
17664020	350 mA	Plug&Play + connection box	10.15-14 W	48.30



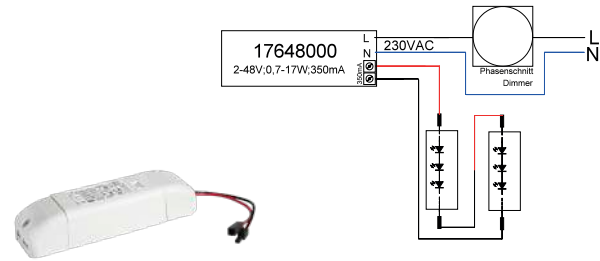
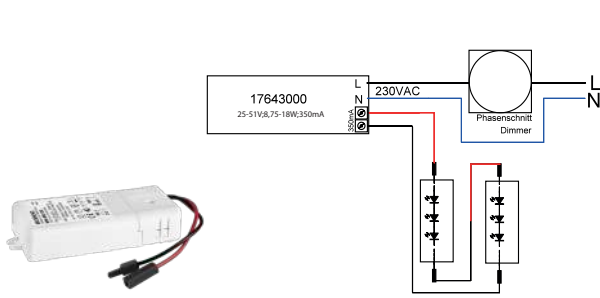

Note: This device is not suitable for usage with the dim2warm LED modules.

LED converter 350 mA, dimmable phase section

This converter is protected against overvoltage and short circuit as well as thermal and electrical overload using fuses. The input and output terminals are suitable for lines with a cross-section of up to 1.5 mm².

Dimensions: L 110.5 x W 52 x H 22 mm, input voltage: AC: 220-240 V, secondary-side circuit type: Series connection, control unit: Phase section, ambient temperature (ta): -25 °C to +50 °C, measuring point (tc): maximum +75 °C, material: Plastic, delivery: Plug&Play model with 110 mm P&P output line

Item no.	Current	Assembly	Power	Price €
17643000	350 mA	Plug&Play	8.75-18 W	40.20
17643010	350 mA	without	8.75-18 W	38.10
17643020	350 mA	Plug&Play + connection box	8.75-18 W	46.60



LED converter 350 mA, dimmable phase section

This operating device fulfills the requirements for safety lighting systems as per DIN EN 50172 VDE 0108-100:2005-01. This converter is protected against overvoltage and short circuit as well as thermal and electrical overload using fuses. The input and output terminals are suitable for lines with a cross-section of up to 1.5 mm².

Dimensions: L 166 x W 46 x H 34 mm, input voltage: AC: 220-240 V, secondary-side circuit type: Series connection, control unit: Phase section, ambient temperature (ta): -25 °C to +50 °C, measuring point (tc): maximum +75 °C, material: Plastic, delivery: Plug&Play model with 110 mm P&P output line

Item no.	Current	Assembly	Power	Price €
17648000	350 mA	Plug&Play	0.7-17 W	99.90
17648010	350 mA	without	0.7-17 W	98.40
17648020	350 mA	Plug&Play + connection box	0.7-17 W	106.90

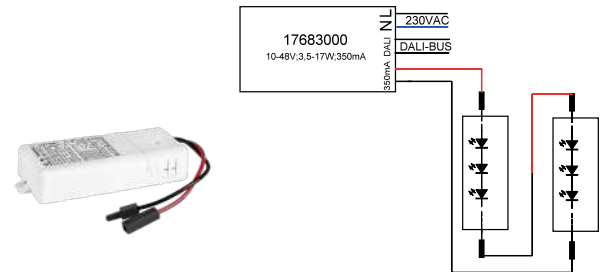
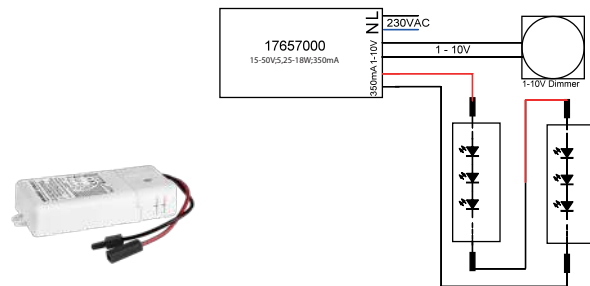

LED converter 350 mA, 1-10 V dimmable (analog)

This converter is protected against overvoltage and short circuit as well as thermal and electrical overload using fuses. The input and output terminals are suitable for lines with a cross-section of up to 1.5 mm².

Dimensions: L 110.5 x W 52 x H 22 mm, input voltage: AC: 110-240 V DC: 178-280 V, secondary-side circuit type: Series connection, control unit: 1-10 V, ambient temperature (ta): -25 °C to +50 °C, measuring point (tc): maximum +80 °C, material: Plastic, delivery: Plug&Play model with 110 mm P&P output line

Item no.	Current	Assembly	Power	Price €
17657000	350 mA	Plug&Play	5.25-18 W	61.40
17657010	350 mA	without	5.25-18 W	59.30



LED converter 350 mA, dimmable DALI (digital)

This operating device fulfills the requirements for safety lighting systems as per DIN EN 50172 VDE 0108-100:2005-01. This converter is protected against overvoltage and short circuit as well as thermal and electrical overload using fuses. The input and output terminals are suitable for lines with a cross-section of up to 0.75-1.5 mm².

Dimensions: L 110.5 x W 52 x H 22 mm, input voltage: AC: 110-240 V DC: 176-280 V, secondary-side circuit type: Series connection, control unit: DALI-2, ambient temperature (ta): -25 °C to +45 °C, measuring point (tc): maximum +75 °C, material: Plastic, delivery: Plug&Play model with 110 mm P&P output line

Item no.	Current	Assembly	Power	Price €
17683000	350 mA	Plug&Play	3.5-17 W	73.10
17683010	350 mA	without	3.5-17 W	71.10
17683020	350 mA	Plug&Play + connection box	3.5-17 W	79.50



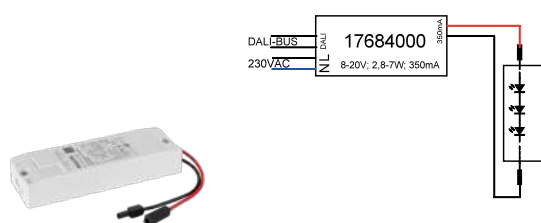

LED converter 350 mA, Dimmable DALI (digital)

NEW

This converter is protected against overvoltage and short circuit as well as electrical overload using fuses. The input and output terminals are suitable for lines with a cross-section of up to 0.75-1.5 mm².

Dimensions: L 130 x W 42 x H 22 mm, input voltage: AC: 220-240 V, DC: 186-250 V, control unit: DALI-2, ambient temperature (ta): -20 °C to +50 °C, measuring point (tc): maximum +70 °C, material: Plastic, delivery: Plug&Play model with 110 mm P&P output line

Item no.	Current	Assembly	Power	Price €
17684000 NEW	350 mA	Plug&Play	2.8-7 W	63.50
17684010 NEW	350 mA	without	2.8-7 W	61.50
17684020 NEW	350 mA	Plug&Play + connection box	2.8-7 W	69.90

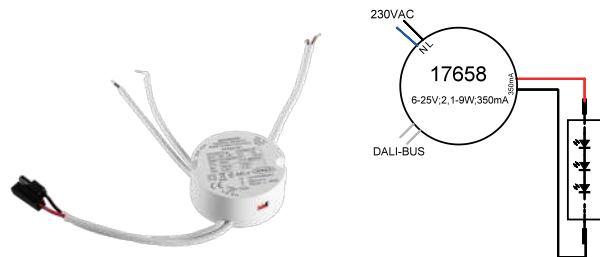

LED round converter 350 mA, Dimmable DALI (digital)

NEW

This converter is protected against overvoltage and short circuit as well as thermal and electrical overload using fuses.

Dimensions: D x H: 56 x 25 mm, input voltage: AC: 220-240 V, control unit: DALI-2, ambient temperature (ta): -20 °C to +45 °C, measuring point (tc): maximum +85 °C, material: Plastic, delivery: Plug&Play model with 110 mm P&P output line

Item no.	Current	Assembly	Power	Price €
17658000 NEW	350 mA	Plug&Play	2.1-9 W	90.10
17658010 NEW	350 mA	without	2.1-9 W	87.40
17658020 NEW	350 mA	Plug&Play + connection box	2.1-9 W	95.90

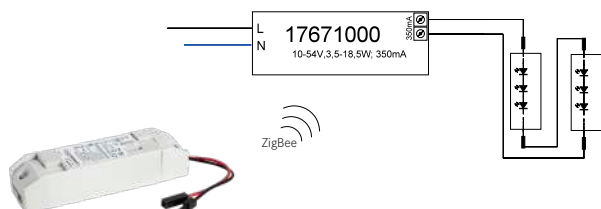

LED converter 350mA, dimmable ZigBee

This operating device fulfills the requirements for safety lighting systems as per DIN EN 50172 VDE 0108-100:2005-01. This converter is protected against overvoltage and short circuit as well as thermal and electrical overload using fuses. The input and output terminals are suitable for lines with a cross-section of up to 1.5 mm².

Dimensions: L 146.5 x W 44 x H 30 mm, input voltage: AC: 220-240 V DC: 198-276 V, secondary-side circuit type: Series connection, control unit: ZigBee, ambient temperature (ta): -25 °C to +45 °C, measuring point (tc): maximum +80 °C, material: Plastic, delivery: Plug&Play model with 110 mm P&P output line

Item no.	Current	Assembly	Power	Price €
17671000	350 mA	Plug&Play	3.5-18.5 W	153.50
17671010	350 mA	without	3.5-18.5 W	151.60
17671020	350 mA	Plug&Play + connection box	3.5-18.5 W	160.10

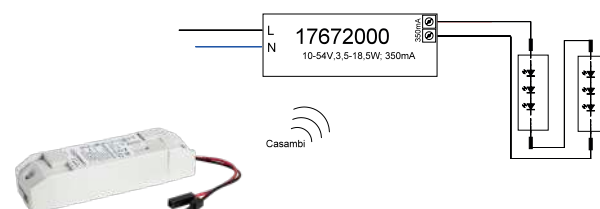

LED converter 350mA, dimmable Casambi

This operating device fulfills the requirements for safety lighting systems as per DIN EN 50172 VDE 0108-100:2005-01. This converter is protected against overvoltage and short circuit as well as thermal and electrical overload using fuses. The input and output terminals are suitable for lines with a cross-section of up to 1.5 mm².

Dimensions: L 146.5 x W 44 x H 30 mm, input voltage: AC: 220-240 V DC: 170-280 V, secondary-side circuit type: Series connection, control unit: Casambi, ambient temperature (ta): -25 °C to +45 °C, measuring point (tc): maximum +80 °C, material: Plastic, delivery: Plug&Play model with 110 mm Plug and Play output line

Item no.	Current	Assembly	Power	Price €
17672000	350 mA	Plug&Play	3.5-18.5 W	189.50
17672010	350 mA	without	3.5-18.5 W	187.70
17672020	350 mA	Plug&Play + connection box	3.5-18.5 W	196.10





LED converter table for 350 mA LED luminaires

LED Power of luminaire	1 W	1.2 W	3 W	3.3 W	6 W	6.1 W	6.8 W	7 W	10 W	10.5 W	11 W	12 W	12.2 W	13.6 W	15 W	20 W	6 W d2w	12 W d2w	
Item no.																			
— 17666000	1-5	1-4	1	1	-	-	-	-	-	-	-	-	-	-	-	-	-	-	-
— 17662xxx	1-7	1-6	1-2	1-2	1	1	1	1	-	-	-	-	-	-	-	-	-	-	-
— 17613xxx	1-15	1-12	1-5	1-4	1-2	1-2	1-2	1-2	1	1	1	1	1	1	1	1	-	-	-
— 17621xxx	1-21	1-17	1-7	1-6	1-3	1-3	1-3	1-3	1-2	1-2	1	1	1	1	1	1	1	-	-
PHASE 17663xxx	3-7	3-5	1-2	1-2	1	1	1	1	-	-	-	-	-	-	-	-	-	1	-
PHASE 17652xxx	6-7	5	2	2	1	1	1	1	-	-	-	-	-	-	-	-	-	1	-
PHASE 17640xxx	5-10	4-8	2-3	2-3	1	1	1	1	1	-	-	-	-	-	-	-	-	1	-
PHASE 17664xxx	11-14	9-11	4	4	2	2	2	2	-	1	1	1	1	1	1	-	-	2	1
PHASE 17643xxx	9-18	8-15	3-6	3-5	2-3	2	2	2	1	1	1	1	1	1	1	1	-	2-3	1
PHASE 17648xxx	1-17	1-14	1-5	1-5	1-2	1-2	1-2	1-2	1	1	1	1	1	1	1	1	-	-	-
I-10 17657xxx	6-18	5-15	2-6	2-5	1-3	1-2	1-2	1-2	1	1	1	1	1	1	1	1	-	1-3	1
BRILL 17683xxx	4-17	3-14	2-5	2-5	1-2	1-2	1-2	1-2	1	1	1	1	1	1	1	1	-	1-2	1
BRILL 17684xxx	3-7	3-5	1-2	1-2	1	1	1	1	-	-	-	-	-	-	-	-	-	1	-
BRILL 17658xxx	3-9	2-7	1-3	1-2	1	1	1	1	-	-	-	-	-	-	-	-	-	1	-
ZigBee 17671xxx	4-18	4-15	2-6	2-5	1-3	1-3	1-2	1-2	1	1	1	1	1	1	1	1	-	1-3	1
Casambi 17672xxx	4-18	4-15	2-6	2-5	1-3	1-3	1-2	1-2	1	1	1	1	1	1	1	1	-	1-3	1

With this overview, we want to provide you with a quick guide for selecting the appropriate LED converter for using our LEDs that are operated with 350 mA. From the power of the LED luminaire, you can see how many luminaires can or must be connected in series to the respective LED converter.

Important for the project planning of phase converters: For uniform switching and dimming behavior, phase converters of the same type and/or item no. must be planned for each switching group and must be operated with the same load as far as possible.



Elbe Philharmonie Hall, Hamburg

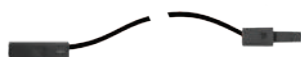

Plug&Play extension cable 350 mA

Plug&Play extension cable for 350 mA (series circuit)

Item no.	Description	Price €
3835	Length: 500 mm	3.80
3836	Length: 1,000 mm	4.75
3837	Length: 2,000 mm	5.50



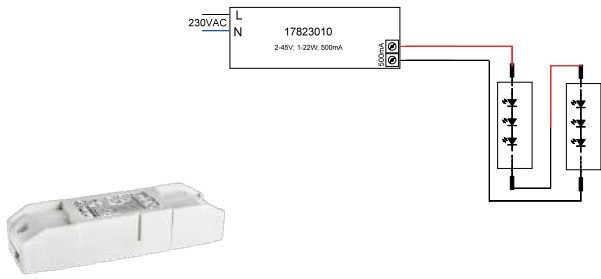

LED converter 500 mA, switchable

This converter is protected against overvoltage and short circuit as well as thermal and electrical overload using fuses. The input and output terminals are suitable for lines with a cross-section of up to 1.5 mm².

Dimensions: L 146.5 x W 43.5 x H 30 mm, input voltage: AC: 220-240 V, DC: 170-280 V, secondary-side circuit type: Series connection, control unit: switchable, ambient temperature (ta): -25 °C to +40 °C, measuring point (tc): maximum +80 °C, material: Plastic

Item no.	Current	Assembly	Power	Price €
17823010	500 mA	without	1-22 W	41.30

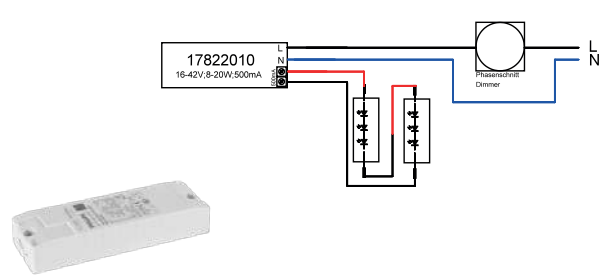

LED converter 500 mA, dimmable phase section

NEW

This operating device fulfills the requirements for safety lighting systems as per DIN EN 50172 VDE 0108-100:2005-01. This converter is protected against overvoltage and short circuit as well as thermal and electrical overload using fuses. The input and output terminals are suitable for lines with a cross-section of up to 2.5 mm².

Dimensions: L 110.5 x W 52 x H 22 mm, input voltage: AC: 220-240 V, control unit: Phase section, ambient temperature (ta): -25 °C to +45 °C, measuring point (tc): maximum +75 °C, material: Plastic

Item no.	Current	Assembly	Power	Price €
17822010	500 mA	without	8-20 W	38.20

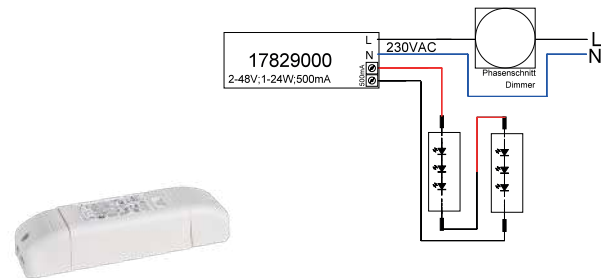

Note: This device is not suitable for usage with the dim2warm LED modules

LED converter 500 mA, Dimmable phase section

This operating device fulfills the requirements for safety lighting systems as per DIN EN 50172 VDE 0108-100:2005-01. This converter is protected against overvoltage and short circuit as well as thermal and electrical overload using fuses. The input and output terminals are suitable for lines with a cross-section of up to 2.5 mm².

Dimensions: L 166 x W 46 x H 34 mm, input voltage: AC: 220-240 V, secondary-side circuit type: Series connection, control unit: Phase section, ambient temperature (ta): -25 °C to +50 °C, measuring point (tc): maximum +75 °C, material: Plastic

Item no.	Current	Assembly	Power	Price €
17829010	500 mA	without	1-24 W	98.30

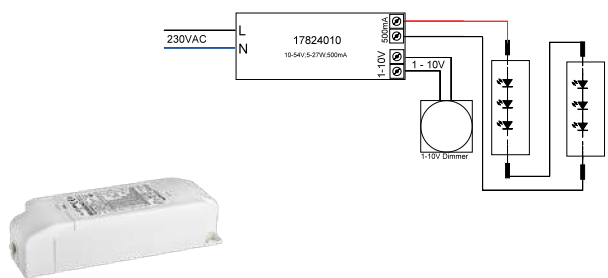

LED converter 500 mA, 1-10 V dimmable (analog)

This converter is protected against overvoltage and short circuit as well as thermal and electrical overload using fuses. The input and output terminals are suitable for lines with a cross-section of up to 0.75-1.5 mm².

Dimensions: L 146.5 x W 43.5 x H 30 mm, input voltage: AC: 220-240 V DC: 170-280 V, secondary-side circuit type: Series connection, control unit: 1-10 V, ambient temperature (ta): -25 °C to +40 °C, measuring point (tc): maximum +80 °C, material: Plastic

Item no.	Current	Assembly	Power	Price €
17824010	500 mA	without	5-27 W	76.30



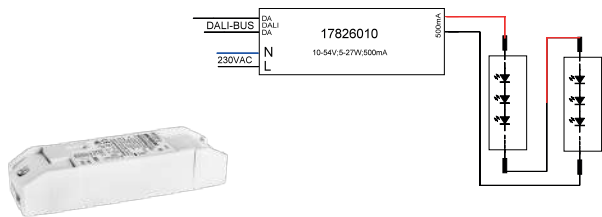

LED converter 500 mA, dimmable DALI (digital)

This converter is protected against overvoltage and short circuit as well as thermal and electrical overload using fuses. The input and output terminals are suitable for lines with a cross-section of up to 0.75-1.5 mm².

Dimensions: L 146.5 x W 44 x H 30 mm, input voltage: AC: 220-240 V DC: 170-280 V, secondary-side circuit type: Series connection, control unit: DALI, dimming range: 1-100%, ambient temperature (ta): -25 °C to +45 °C, measuring point (tc): maximum +85 °C,

Material: Plastic

Item no.	Current	Assembly	Power	Price €
17826010	500 mA	without	5-27 W	78.40



LED converter table for 500 mA LED luminaires

LED Power of luminaire	5 W	8.9 W	9.2 W	9.3 W	14 W	20 W	9.4 W d2w	
Item no.								
—	17823010	1-4	1-2	1-2	1-2	1	1	-
PHASE	17822010	2-4	1-2	1-2	1-2	1	1	1-2
PHASE	17829010	1-4	1-2	1-2	1-2	1	1	-
1-10	17824010	2-5	1-3	1-2	1-2	1	1	1-2
DALI	17826010	2-5	1-3	1-2	1-2	1	1	1-2

With this overview, we want to provide you with a quick guide for selecting the appropriate LED converter for using our LEDs that are operated with 500mA. From the power of the LED luminaire, you can see how many luminaires can or must be connected in series to the respective LED converter.

Important for the project planning of phase converters: For uniform switching and dimming behavior, phase converters **of the same type** and/or item no. must be planned for each switching group and must be operated with **the same load as far as possible**.

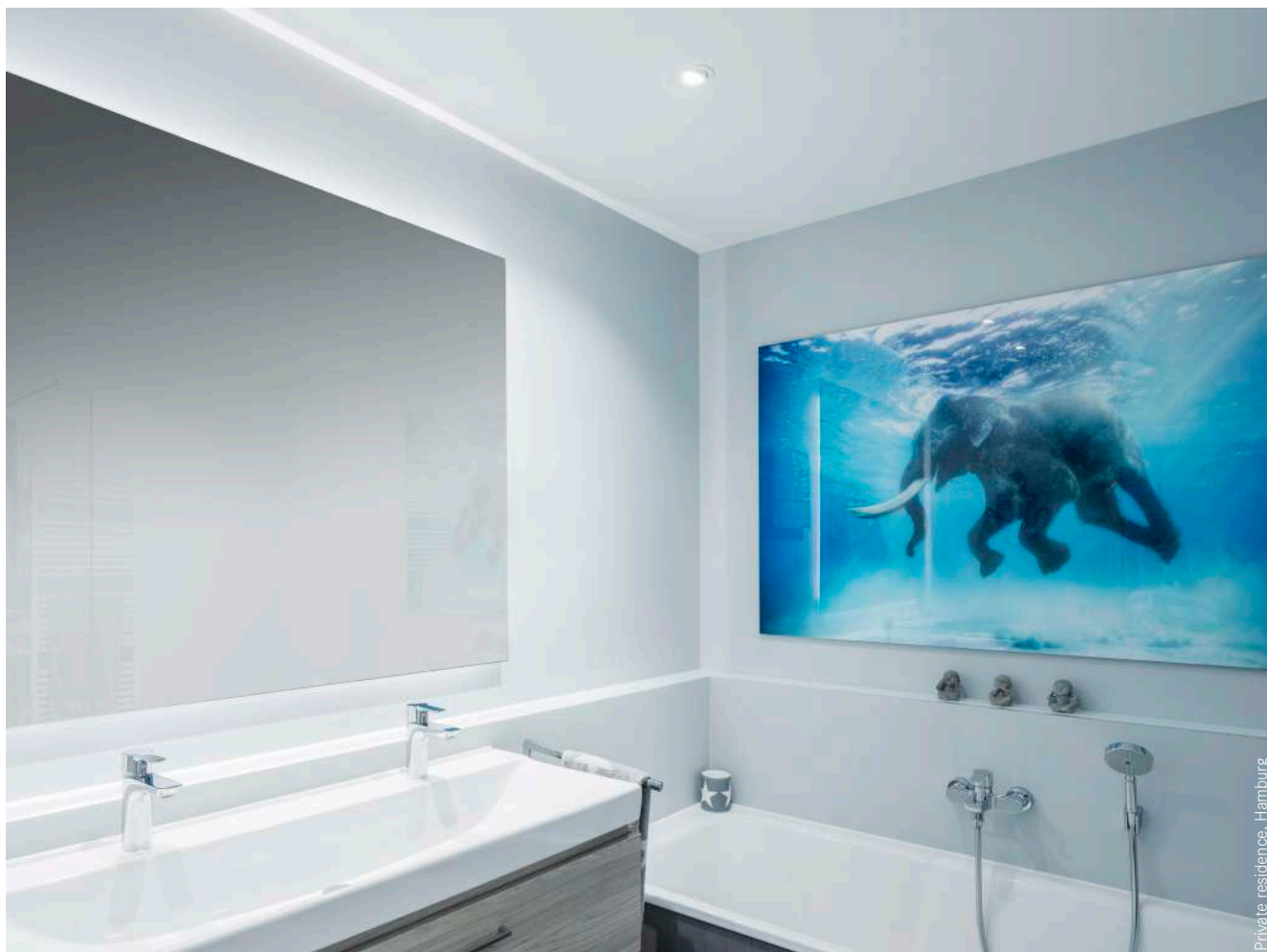

Private residence, Hamburg

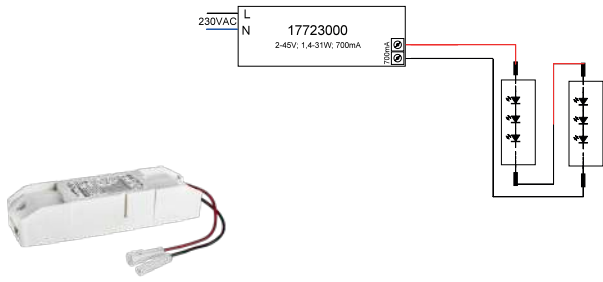

LED converter 700 mA, switchable

This converter is protected against overvoltage and short circuit as well as thermal and electrical overload using fuses. The input and output terminals are suitable for lines with a cross-section of up to 1.5 mm².

Dimensions: L 146.5 x W 43.5 x H 30 mm, input voltage: AC: 220-240 V DC: 170-280 V, secondary-side circuit type: Series connection, control unit: switchable, ambient temperature (ta): -25 °C to +40 °C, measuring point (tc): maximum +80 °C, material: Plastic, delivery: Plug&Play model with 110 mm P&P output line

Item no.	Current	Assembly	Power	Price €
17723000	700 mA	Plug&Play	1.4-31 W	43.40
17723010	700 mA	without	1.4-31 W	41.30
17723020	700 mA	Plug&Play + connection box	1.4-31 W	49.90

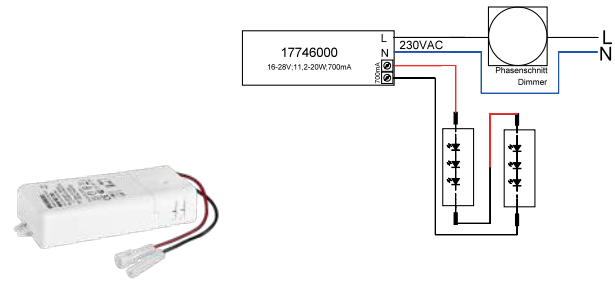

LED converter 700 mA, Dimmable phase section

This converter is protected against overvoltage and short circuit as well as thermal and electrical overload using fuses. The input and output terminals are suitable for lines with a cross-section of up to 1.5 mm².

Dimensions: L 110.5 x W 52 x H 22 mm, input voltage: AC: 220-240 V, secondary-side circuit type: Series connection, control unit: Phase section, ambient temperature (ta): -25 °C to +45 °C, measuring point (tc): maximum +75 °C, material: Plastic, delivery: Plug&Play model with 110 mm P&P output line

Item no.	Current	Assembly	Power	Price €
17746000	700 mA	Plug&Play	11.2-20 W	40.30
17746010	700 mA	without	11.2-20 W	38.20
17746020	700 mA	Plug&Play + connection box	11.2-20 W	46.70

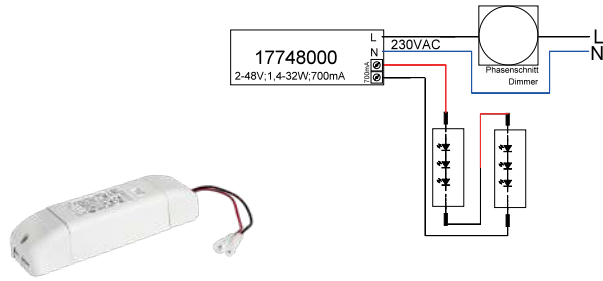

LED converter 700 mA, Dimmable phase section

This operating device fulfills the requirements for safety lighting systems as per DIN EN 50172 VDE 0108-100:2005-01. This converter is protected against overvoltage and short circuit as well as thermal and electrical overload using fuses. The input and output terminals are suitable for lines with a cross-section of up to 1.5 mm².

Dimensions: L 166 x W 46 x H 34 mm, input voltage: AC: 220-240 V, secondary-side circuit type: Series connection, control unit: Phase section, ambient temperature (ta): -25 °C to +50 °C, measuring point (tc): maximum +75 °C, material: Plastic, delivery: Plug&Play model with 110 mm P&P output line

Item no.	Assembly	Power	Price €
17748000	Plug&Play	1.4-32 W	100.50
17748010	without	1.4-32 W	98.40
17748020	Plug&Play + connection box	1.4-32 W	106.90

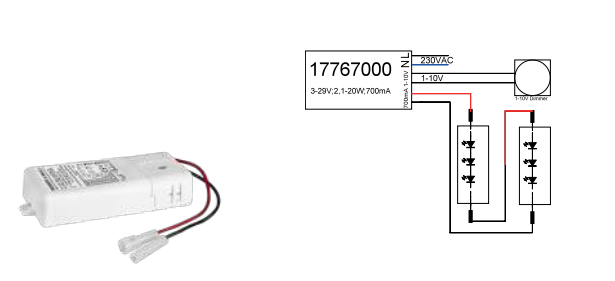

LED converter 700 mA, 1-10 V dimmable (analog)

This converter is protected against overvoltage and short circuit as well as thermal and electrical overload using fuses. The input and output terminals are suitable for lines with a cross-section of up to 1.5 mm².

Dimensions: L 110.5 x W 52 x H 22 mm, input voltage: AC: 110-240 V DC: 168-280 V, secondary-side circuit type: Series connection, control unit: 1-10 V, ambient temperature (ta): -25 °C to +50 °C, measuring point (tc): maximum +80 °C, material: Plastic, delivery: Plug&Play model with 110 mm P&P output line

Item no.	Current	Assembly	Power	Price €
17767000	700 mA	Plug&Play	2.1-20 W	61.50
17767010	700 mA	without	2.1-20 W	59.40
17767020	700 mA	Plug&Play + connection box	2.1-20 W	67.90



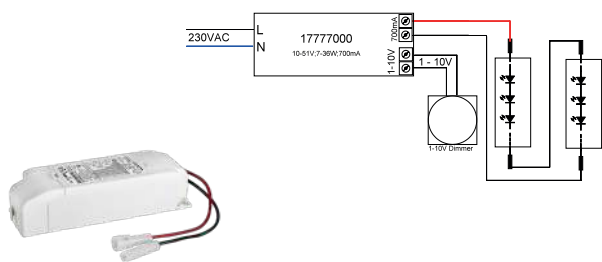

LED converter 700 mA, 1-10 V dimmable (analog)

This converter is protected against overvoltage and short circuit as well as thermal and electrical overload using fuses. The input and output terminals are suitable for lines with a cross-section of up to 0.5-1.5 mm².

Dimensions: L 146.5 x W 43.5 x H 30 mm, input voltage: AC: 220-240 V DC: 170-280 V, secondary-side circuit type: Series connection, control unit: 1-10 V, ambient temperature (ta): -25 °C to +40 °C, measuring point (tc): maximum +80 °C, material: Plastic, delivery: Plug&Play model with 110 mm P&P output line

Item no.	Current	Assembly	Power	Price €
17777000	700 mA	Plug&Play	7-36 W	78.40
17777010	700 mA	without	7-36 W	76.40

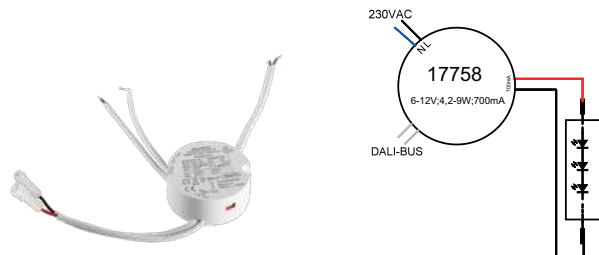

LED round converter 700 mA, Dimmable DALI (digital)

NEW

This converter is protected against overvoltage and short circuit as well as thermal and electrical overload using fuses.

Dimensions: D x H: 56 x 25 mm, input voltage: AC: 220-240 V, control unit: DALI-2, ambient temperature (ta): -20 °C to +45 °C, measuring point (tc): maximum +85 °C, material: Plastic, delivery: Plug&Play model with 110 mm P&P output line

Item no.	Current	Assembly	Power	Price €
17758000 NEW	700 mA	Plug&Play	4.2-9 W	90.10
17758010 NEW	700 mA	without	4.2-9 W	87.40
17758020 NEW	700 mA	Plug&Play + connection box	4.2-9 W	95.90

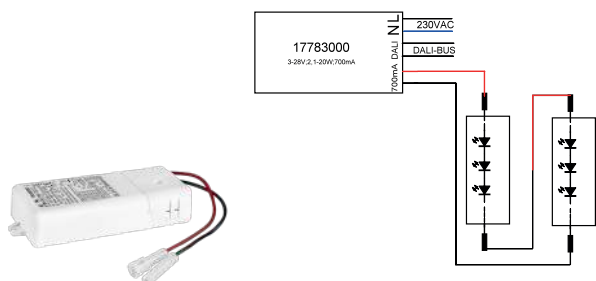

LED converter 700 mA, Dimmable DALI (digital)

This converter is protected against overvoltage and short circuit as well as thermal and electrical overload using fuses. The input and output terminals are suitable for lines with a cross-section of up to 0.75-1.5 mm².

Dimensions: L 110.5 x W 52 x H 22 mm, input voltage: AC: 110-240 V DC: 176-280 V, secondary-side circuit type: Series connection, control unit: DALI-2, ambient temperature (ta): -25 °C to +45 °C, measuring point (tc): maximum +75 °C, material: Plastic, delivery: Plug&Play model with 110 mm P&P output line

Item no.	Current	Assembly	Power	Price €
17783000	700 mA	Plug&Play	2.1-20 W	73.10
17783010	700 mA	without	2.1-20 W	71.10
17783020	700 mA	Plug&Play + connection box	2.1-20 W	79.50

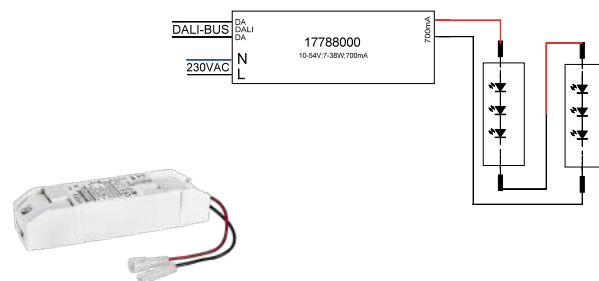

LED converter 700 mA, Dimmable DALI (digital)

This converter is protected against overvoltage and short circuit as well as thermal and electrical overload using fuses. The input and output terminals are suitable for lines with a cross-section of up to 0.75-1.5 mm².

Dimensions: L 146.5 x W 44 x H 30 mm, input voltage: AC: 220-240 V DC: 170-280 V, secondary-side circuit type: Series connection, control unit: DALI-2, dimming range: 1-100%, ambient temperature (ta): -25 °C to +45 °C, measuring point (tc): maximum +85 °C, material: Plastic, delivery: Plug&Play model with 110 mm P&P output line

Item no.	Current	Assembly	Power	Price €
17788000	700 mA	Plug&Play	7-38 W	80.50
17788010	700 mA	without	7-38 W	78.50
17788020	700 mA	Plug&Play + connection box	7-38 W	87.00



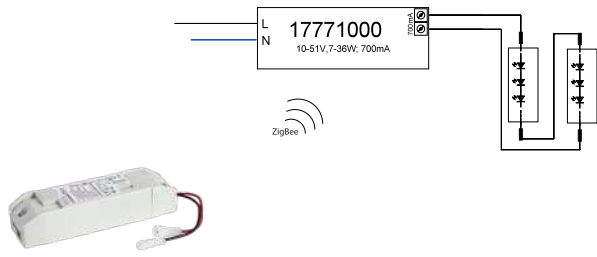

LED converter 700 mA, Dimmable ZigBee

This operating device fulfills the requirements for safety lighting systems as per DIN EN 50172 VDE 0108-100:2005-01. This converter is protected against overvoltage and short circuit as well as thermal and electrical overload using fuses. The input and output terminals are suitable for lines with a cross-section of up to 1.5 mm².

Dimensions: L 146.5 x W 44 x H 30 mm, input voltage: AC: 220-240 V DC: 198-276 V, secondary-side circuit type: Series connection, control unit: ZigBee, ambient temperature (ta): -25 °C to +45 °C, measuring point (tc): maximum +80 °C, material: Plastic, delivery: Plug&Play model with 110 mm P&P output line

Item no.	Current	Assembly	Power	Price €
17771000	700 mA	Plug&Play	7-36 W	153.70
17771010	700 mA	without	7-36 W	151.60
17771020	700 mA	Plug&Play + connection box	7-36 W	160.10

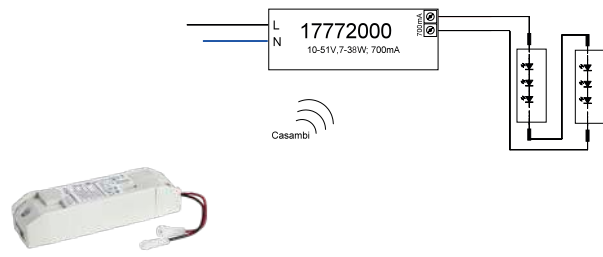

LED converter 700 mA, Dimmable Casambi

This operating device fulfills the requirements for safety lighting systems as per DIN EN 50172 VDE 0108-100:2005-01. This converter is protected against overvoltage and short circuit as well as thermal and electrical overload using fuses. The input and output terminals are suitable for lines with a cross-section of up to 1.5 mm².

Dimensions: L 146.5 x W 44 x H 30 mm, input voltage: AC: 220-240 V, DC: 170-280 V, secondary-side circuit type: Series connection, control unit: Casambi, ambient temperature (ta): -25 °C to +45 °C, measuring point (tc): maximum +80 °C, material: Plastic, delivery: Plug&Play model with 110 mm P&P output line

Item no.	Current	Assembly	Power	Price €
17772000	700 mA	Plug&Play	7-38 W	189.80
17772010	700 mA	without	7-38 W	187.70
17772020	700 mA	Plug&Play + connection box	7-38 W	196.10



LED converter table for 700 mA LED luminaires

LED Power of luminaire	LED Power of luminaire					
	2 W	3 W	7 W	13.6 W	30 W	
Item no.						
—	17723xxx	1-15	1-10	1-4	1-2	1
	17746xxx	6-10	4-6	2	1	-
	17748xxx	1-16	1-10	1-4	1-2	1
	17767xxx	2-10	1-6	1-2	1	-
	17777xxx	4-18	3-12	2-5	1-2	1
	17758xx	3-4	2-3	1	-	-
	17783xxx	2-10	1-6	1-2	1	-
	17788xxx	4-19	3-12	2-5	1-2	1
ZigBee	17771xxx	4-19	3-12	2-5	1-2	1
Casambi	17772xxx	4-19	3-12	2-5	1-2	1

With this overview, we want to provide you with a quick guide for selecting the appropriate LED converter for using our LEDs that are operated with 700 mA. From the power of the LED luminaire, you can see how many luminaires can or must be connected in series to the respective LED converter.

Important for the project planning of phase converters: For uniform switching and dimming behavior, phase converters of the same type and/or item no. must be planned for each switching group and must be operated with the same load as far as possible.



Plug&Play extension cable 700 mA

Plug&Play extension cable for 700 mA (series circuit)

Item no.	Description	Price €
3838	Length: 500 mm	4.20
3839	Length: 1,000 mm	4.80
3840	Length: 2,000 mm	5.80



Tax Office, Berlin

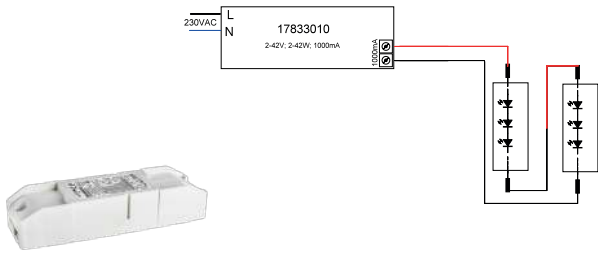

LED converter 1,000 mA, switchable

This converter is protected against overvoltage and short circuit as well as thermal and electrical overload using fuses. The input and output terminals are suitable for lines with a cross-section of up to 0.75-1.5 mm².

Dimensions: L 146.5 x W 43.5 x H 30 mm, input voltage: AC: 220-240 V, DC: 170-280 V, secondary-side circuit type: Series connection, control unit: switchable, ambient temperature (ta): -25 °C to +40 °C, measuring point (tc): maximum +80 °C, material: Plastic

Item no.	Current	Assembly	Power	Price €
17833010	1,000 mA	without	2-42 W	41.30

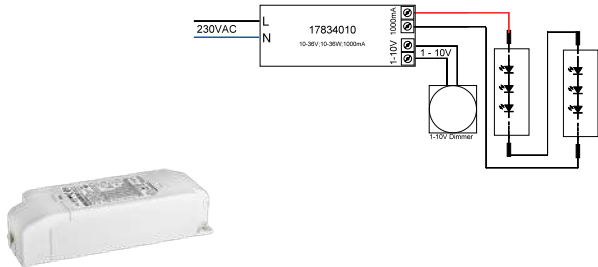

LED converter 1,000 mA, 1-10 V dimmable (analog)

This converter is protected against overvoltage and short circuit as well as thermal and electrical overload using fuses. The input and output terminals are suitable for lines with a cross-section of up to 0.75-1.5 mm².

Dimensions: L 146.5 x W 43.5 x H 30 mm, input voltage: AC: 220-240 V, DC: 170-280 V, secondary-side circuit type: Series connection, control unit: 1-10 V, ambient temperature (ta): -25 °C to +40 °C, measuring point (tc): maximum +80 °C, material: Plastic

Item no.	Current	Assembly	Power	Price €
17834010	1,000 mA	without	10-36 W	76.30

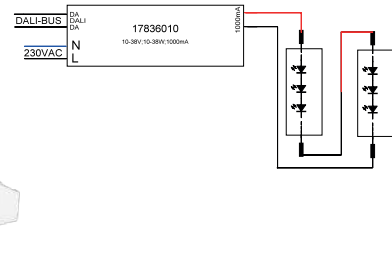

LED converter 1,000 mA, Dimmable DALI (digital)

This converter is protected against overvoltage and short circuit as well as thermal and electrical overload using fuses. The input and output terminals are suitable for lines with a cross-section of up to 0.75-1.5 mm².

Dimensions: L 146.5 x W 44 x H 30 mm, input voltage: AC: 220-240 V, DC: 170-280 V, secondary-side circuit type: Series connection, control unit: DALI, dimming range: 1-100%, ambient temperature (ta): -25 °C to +45 °C, measuring point (tc): maximum +85 °C, material: Plastic

Item no.	Current	Assembly	Power	Price €
17836010	1,000 mA	without	10-38 W	78.50



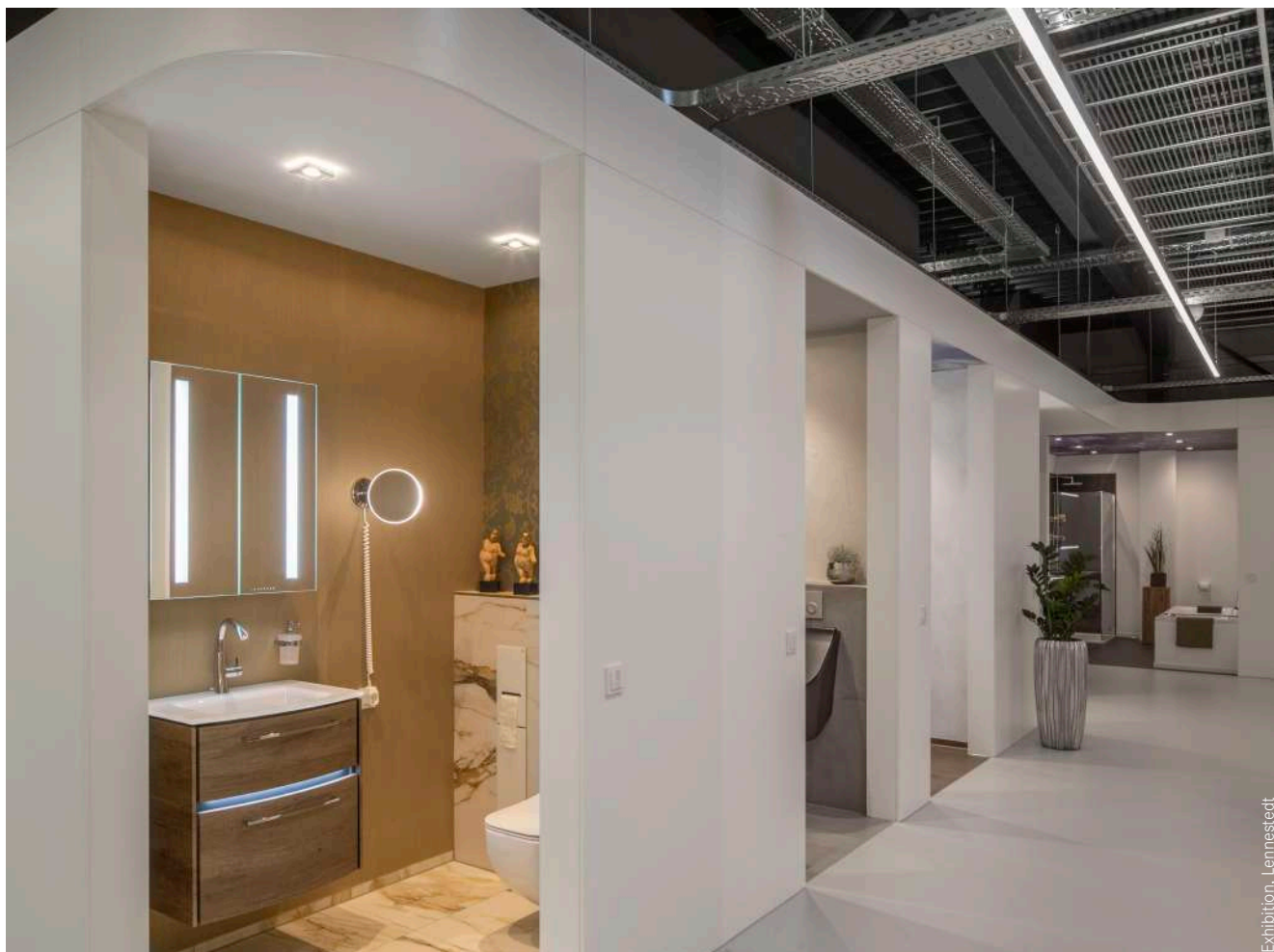

Exhibition, Lemmstedt



Connection box, 230 V AC, 3-pin

3-pin connection box with 100-mm connection cable, material: Plastic. The input terminal is suitable for lines with a cross-section from 0.5 to 2.5 mm².

Item no.	Voltage	Current	Price €
83330000	230 V	maximum 16 A	6.90

IP20



Connection box, 230 V AC, 5-pin (DALI / 1-10 V)

5-pin connection box with 100-mm connection cable, material: Plastic. The input terminal is suitable for lines with a cross-section from 0.5 to 2.5 mm².

Item no.	Voltage	Current	Price €
83331000	230 V	maximum 16 A	10.50

IP20

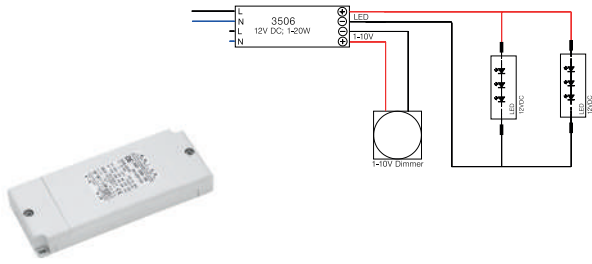

LED power supply 12 V DC, 1-10 V dimmable (analog)

This power supply fulfills the requirements for safety lighting systems as per DIN EN 50172 VDE 0108-100:2005-01. This power supply is protected against overvoltage and short circuit as well as thermal and electrical overload using fuses. The input and output terminals are suitable for lines with a cross-section of up to 1.5 mm².

Dimensions: L 146 x W 55 x H 19 mm, input voltage: AC: 110-240 V, DC: 176-264 V, frequency: 50 Hz, control unit: 1-10 V, Ambient temperature (ta): -20 °C to +50 °C, Measuring point (tc): maximum +80 °C, material: Plastic

Item no.	Secondary voltage	Power	Price €
3506	12 V	0-20 W	54.00

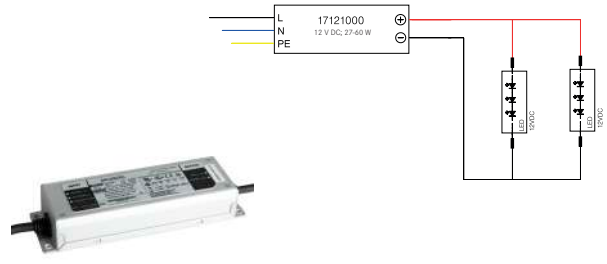

LED power supply 12 V DC, switchable

This power supply is protected against overvoltage and short circuit as well as thermal and electrical overload using fuses.

Dimensions: L 180 x W 63 x H 36 mm, input voltage: AC: 100-305 V, DC: 142-431 V, frequency: 50 Hz, control unit: switchable, Ambient temperature (ta): -40 °C to +80 °C, Measuring point (tc): maximum +85 °C, material: Aluminum

Item no.	Secondary voltage	Power	Price €
17121000	12 V	1-60 W	112.30

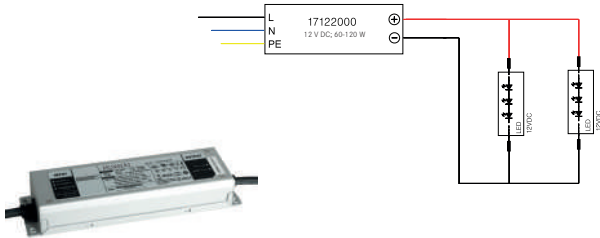

LED power supply 12 V DC, switchable

This power supply is protected against overvoltage and short circuit as well as thermal and electrical overload using fuses.

Dimensions: L 219 x W 63 x H 36 mm, input voltage: AC: 100-305 V, DC: 142-431 V, frequency: 50 Hz, control unit: switchable, ambient temperature (ta): -40 °C to +80 °C, measuring point (tc): maximum +90 °C, material: Aluminum

Item no.	Secondary voltage	Power	Price €
17122000	12 V	1-120 W	133.50



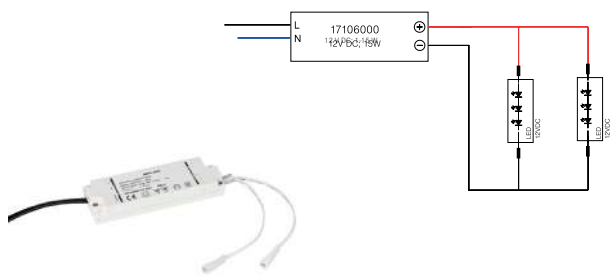

LED power supply 12 V DC, switchable

This power supply is protected against overvoltage and short circuit as well as thermal and electrical overload using fuses.

Dimensions: L 105 x W 49 x H 18 mm, input voltage: AC: 200-240 V, frequency: 50 Hz, control unit: switchable, ambient temperature (ta): 0 °C to +45 °C, measuring point (tc): maximum +75 °C, material: Plastic, delivery: including 2,000 mm input line (Euro flat plug) and 2 x 150 mm output line with plug-in system

Item no.	Secondary voltage	Power	Price €
17106000	12 V	1-15 W	52.30



6-fold distributor 12 V DC for 17106 / 17110

Power: maximum 30 W

Item no.	Price €
17107000	12.00

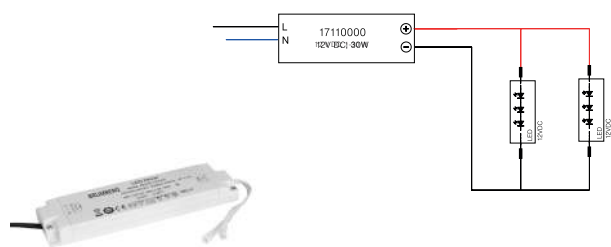

LED power supply 12 V DC, switchable

This power supply is protected against overvoltage and short circuit as well as thermal and electrical overload using fuses.

Dimensions: L 185 x W 48 x H 20 mm, input voltage: AC: 200-240 V, frequency: 50 Hz, control unit: switchable, ambient temperature (ta): 0 °C to +45 °C, measuring point (tc): maximum +85 °C, material: Plastic, delivery: including 2,000 mm input line (Euro flat plug) and 2 x 150 mm output line with plug-in system

Item no.	Secondary voltage	Power	Price €
17110000	12 V	1-30 W	80.60



Extension cable 12 V DC for 17106 / 17110 / 17107

Cable length: 2,000 mm

Item no.	Price €
17108000	8.70

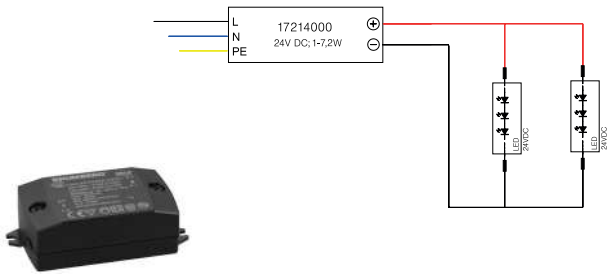

LED power supply 24 V DC, switchable

This power supply is protected against overvoltage and short circuit as well as thermal and electrical overload using fuses. The input and output terminals are suitable for lines with a cross-section of up to 1.5 mm².

Dimensions: L 68 x W 35 x H 21 mm, input voltage: AC: 90-264 V, frequency: 50 Hz, control unit: switchable, ambient temperature (ta): -20 °C to +40 °C, measuring point (tc): maximum +70 °C, material: Plastic

Item no.	Secondary voltage	Power	Price €
17214000	24 V	1-7.2 W	26.60

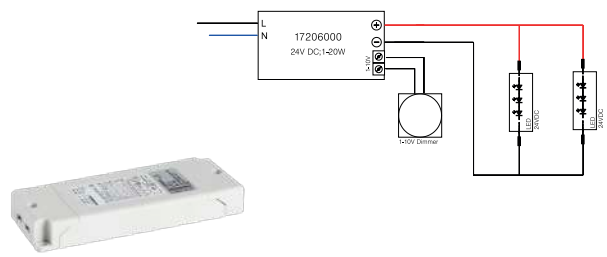

LED power supply 24 V DC, 1-10 V dimmable (analog)

This power supply fulfills the requirements for safety lighting systems as per DIN EN 50172 VDE 0108-100:2005-01. This power supply is protected against overvoltage and short circuit as well as thermal and electrical overload using fuses.

Dimensions: L 146 x W 55 x H 19 mm, input voltage: AC: 90-264 V, DC: 176-264 V, frequency: 50 Hz, control unit: 1-10 V, ambient temperature (ta): -25 °C to +50 °C, measuring point (tc): maximum +80 °C, material: Plastic

Item no.	Secondary voltage	Power	Price €
17206000	24 V	1-20 W	53.70

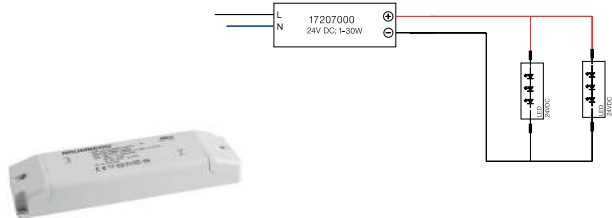

LED power supply 24 V DC, switchable

This power supply is protected against overvoltage and short circuit as well as thermal and electrical overload using fuses. The input and output terminals are suitable for lines with a cross-section of up to 2.5 mm².

Dimensions: L 160 x W 50 x H 22 mm, input voltage: AC: 90-264 V DC: 140-370 V, frequency: 50 Hz, control unit: switchable, ambient temperature (ta): -20 °C to +50 °C, measuring point (tc): maximum +75 °C, material: Plastic

Item no.	Secondary voltage	Power	Price €
17207000	24 V	1-30 W	61.40

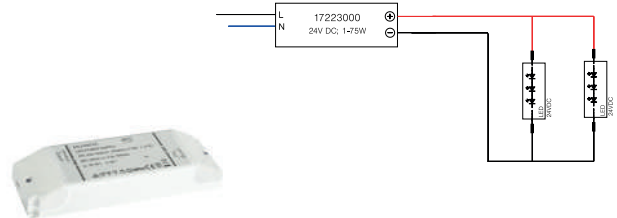

LED power supply 24 V DC, switchable

This power supply is protected against overvoltage and short circuit as well as thermal and electrical overload using fuses. The input and output terminals are suitable for lines with a cross-section of up to 1.0 mm².

Dimensions: L 185 x W 60 x H 31 mm, input voltage: AC: 198-264 V, control unit: switchable, ambient temperature (ta): -20 °C to +50 °C, measuring point (tc): maximum +85 °C, material: Plastic

Item no.	Secondary voltage	Power	Price €
17223000	24 V	1-75 W	110.20



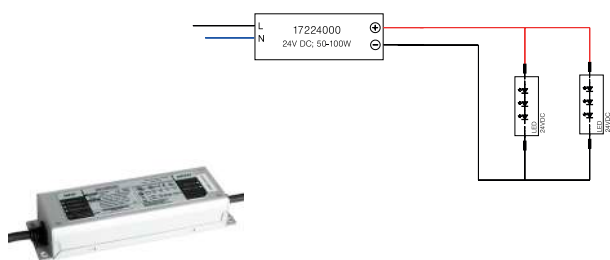

LED power supply 24 V DC, switchable

This power supply is protected against overvoltage and short circuit as well as thermal and electrical overload using fuses.

Dimensions: L 199 x W 63 x H 36 mm, input voltage: AC: 100-305 V, DC: 142-431 V, control unit: switchable, ambient temperature (ta): -40 °C to +60 °C, measuring point (tc): maximum +90 °C, material: Aluminum

Item no.	Secondary voltage	Power	Price €
17224000	24 V	1-100 W	122.90

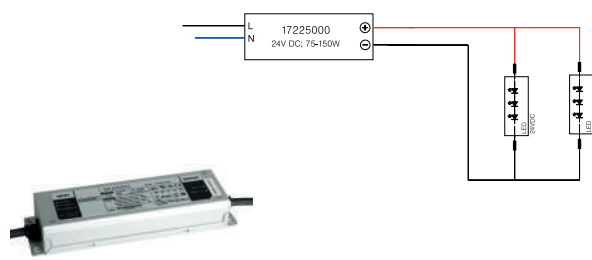

LED power supply 24 V DC, switchable

This power supply is protected against overvoltage and short circuit as well as thermal and electrical overload using fuses.

Dimensions: L 219 x W 63 x H 36 mm, input voltage: AC: 100-305 V, DC: 142-431 V, control unit: switchable, ambient temperature (ta): -40 °C to +55 °C, measuring point (tc): maximum +90 °C, material: Aluminum

Item no.	Secondary voltage	Power	Price €
17225000	24 V	1-150 W	133.50

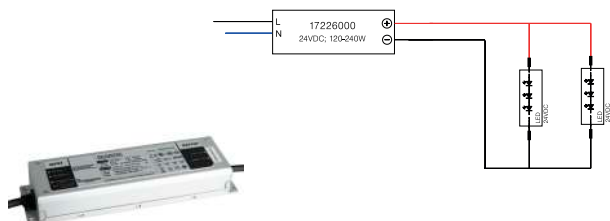

LED power supply 24 V DC, switchable

This power supply is protected against overvoltage and short circuit as well as thermal and electrical overload using fuses.

Dimensions: L 244 x W 71 x H 38 mm, input voltage: AC: 100-305 V, DC: 142-432 V, control unit: switchable, ambient temperature (ta): -40 °C to +50 °C, measuring point (tc): maximum +90 °C, material: Aluminum

Item no.	Secondary voltage	Power	Price €
17226000	24 V	1-240 W	173.80



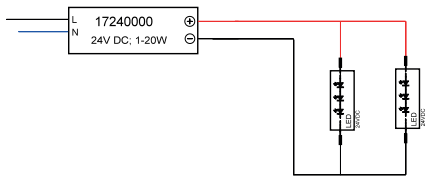

LED power supply 24 V DC, switchable NEW

This power supply is protected against overvoltage and short circuit as well as thermal and electrical overload using fuses. The input and output terminals are suitable for lines with a cross-section of up to 1.5 mm².

Dimensions: L 150 x W 40 x H 30 mm,
 Input voltage: AC: 120-240 V,
 Frequency: 50 Hz, control unit: switchable,
 Ambient temperature (ta): -20 °C to +45 °C,
 Measuring point (tc): maximum +85 °C,
 Material: Plastic

Item no.	Secondary voltage	Power	Price €
17240000 NEW	24 V	1-20 W	24.90

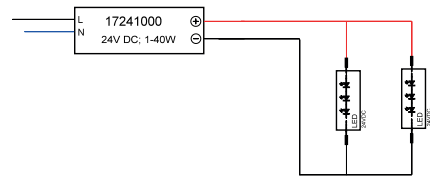

LED power supply 24 V DC, switchable NEW

This power supply is protected against overvoltage and short circuit as well as thermal and electrical overload using fuses. The input and output terminals are suitable for lines with a cross-section of up to 1.5 mm².

Dimensions: L 210 x W 40 x H 30 mm,
 Input voltage: AC: 120-240 V,
 Frequency: 50 Hz, control unit: switchable,
 Ambient temperature (ta): -20 °C to +45 °C,
 Measuring point (tc): maximum +85 °C,
 Material: Plastic

Item no.	Secondary voltage	Power	Price €
17241000 NEW	24 V	1-40 W	32.90

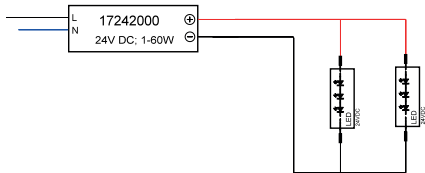

LED power supply 24 V DC, switchable NEW

This power supply is protected against overvoltage and short circuit as well as thermal and electrical overload using fuses. The input and output terminals are suitable for lines with a cross-section of up to 1.5 mm².

Dimensions: L 250 x W 40 x H 30 mm,
 Input voltage: AC: 120-240 V,
 Frequency: 50 Hz, control unit: switchable,
 Ambient temperature (ta): -20 °C to +45 °C,
 Measuring point (tc): maximum +85 °C,
 Material: Plastic

Item no.	Secondary voltage	Power	Price €
17242000 NEW	24 V	1-60 W	43.90

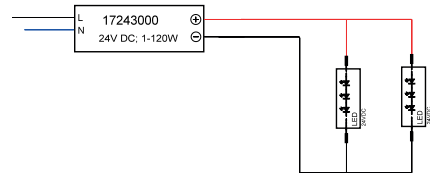

LED power supply 24 V DC, switchable NEW

This power supply is protected against overvoltage and short circuit as well as thermal and electrical overload using fuses. The input and output terminals are suitable for lines with a cross-section of up to 1.5 mm².

Dimensions: L 300 x W 40 x H 30 mm,
 Input voltage: AC: 120-240 V,
 Frequency: 50 Hz, control unit: switchable,
 Ambient temperature (ta): -20 °C to +45 °C,
 Measuring point (tc): maximum +85 °C,
 Material: Plastic

Item no.	Secondary voltage	Power	Price €
17243000 NEW	24 V	1-120 W	66.90



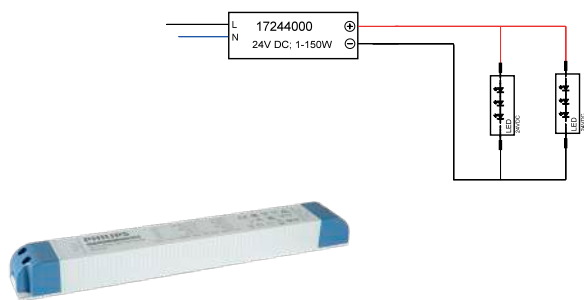

LED power supply 24 V DC, switchable

NEW

This power supply is protected against overvoltage and short circuit as well as thermal and electrical overload using fuses. The input and output terminals are suitable for lines with a cross-section of up to 1.5 mm².

Dimensions: L 310 x W 40 x H 30 mm,
 Input voltage: AC: 120-240 V,
 Frequency: 50 Hz, control unit: switchable,
 Ambient temperature (ta): -20 °C to +45 °C,
 Measuring point (tc): maximum +85 °C,
 Material: Plastic

Item no.	Secondary voltage	Power	Price €
17244000 NEW	24 V	1-150 W	79.90

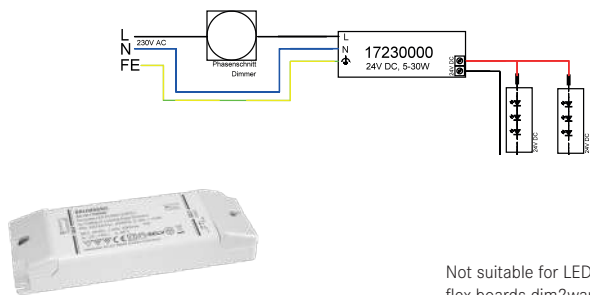

Not suitable for LED flex boards dim2warm.

LED power supply 24 V DC, Dimmable phase section

NEW

This power supply is protected against overvoltage and short circuit as well as thermal and electrical overload using fuses.

Dimensions: L 145 x W 50 x H 22 mm,
 Input voltage: AC: 220-240 V,
 Frequency: 50 Hz, control unit: Phase section,
 Ambient temperature (ta): -20 °C to +50 °C,
 Measuring point (tc): maximum +80 °C,
 Material: Plastic

Item no.	Secondary voltage	Power	Price €
17230000 NEW	24 V	5-30 W	59.90

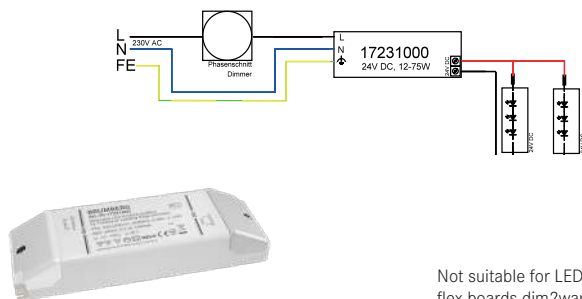

Not suitable for LED flex boards dim2warm.

LED power supply 24 V DC, Dimmable phase section

NEW

This power supply is protected against overvoltage and short circuit as well as thermal and electrical overload using fuses.

Dimensions: L 185 x W 60 x H 31 mm,
 Input voltage: AC: 220-240 V,
 Frequency: 50 Hz, control unit: Phase section,
 Ambient temperature (ta): -10 °C to +45 °C,
 Measuring point (tc): maximum +80 °C,
 Material: Plastic

Item no.	Secondary voltage	Power	Price €
17231000 NEW	24 V	12-75 W	108.90

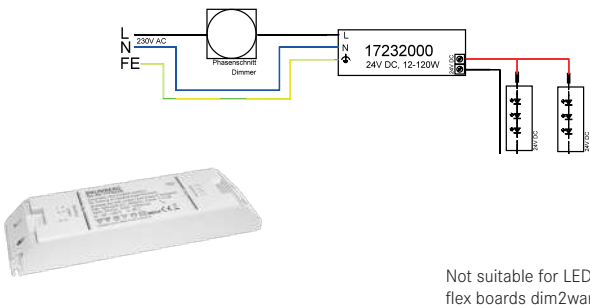

Not suitable for LED flex boards dim2warm.

LED power supply 24 V DC, Dimmable phase section

NEW

This power supply is protected against overvoltage and short circuit as well as thermal and electrical overload using fuses.

Dimensions: L 223 x W 64 x H 32 mm,
 Input voltage: AC: 220-240 V,
 Frequency: 50 Hz, control unit: Phase section,
 Ambient temperature (ta): -20 °C to +45 °C,
 Measuring point (tc): maximum +85 °C,
 Material: Plastic

Item no.	Secondary voltage	Power	Price €
17232000 NEW	24 V	12-120 W	124.90





LED dimmer 12-24 V DC, dimmable

LED dimmer series for constant voltage operation (12-24 V DC)

Using 4 channels (single or multi-color). Wiring is carried out via plug-in terminals without using screws. Line cross-section: 0.5-2.5 mm². An external power supply is required for operation, output signal (dimming): PWM (pulse width modulation), with reverse polarity and overtemperature protection.

Maximum output current: 10 A (4 x 2.5 A; 3 x 3.33 A; 2 x 5 A; 1 x 5 A)
 Maximum output power 12 V: 120 W (4 x 30 W; 3 x 40 W; 2 x 60 W; 1 x 60 W)
 Maximum output power 24 V: 240 W (4 x 60 W; 3 x 80 W; 2 x 120 W; 1 x 120 W)

18151000: 4-channel device with a maximum of 4 addresses (KNX). One address is assigned to each channel (output).

The KNX dimmer can be used for monochrome, RGB and RGBW luminaires. KNX certified device, can be configured using the ETS software (4.0F or higher). The system application and the KNXPROD file in German can be downloaded from www.brumberg.com. Functions / objects: Switching, relative dimming, absolute dimming, preset, scenes, color sequences, two pre-programmed color gradients, etc.

18152000: 1 to 4-channel device with 1-4 addresses (DALI). Channels (outputs) can be combined with 1, 2, 3 or 4 addresses. As an alternative to DALI, the 4 channels (outputs) can be controlled (dimmed) simultaneously, i.e. all four channels behave in the same way, using a pushbutton (push-dimm, switch-dimm).

18153000: 1 to 4-channel device with 1-4 addresses (DMX). Channels (outputs) can be combined with 1, 2, 3 or 4 addresses.

18154000: 1 to 4-channel device with a maximum of 4 x 1-10 V inputs. The inputs can be combined with each other.

18155000: 2 x 2-channel device with one address (DALI DT8) for TunableWhite luminaires. Two channels (outputs) are combined in each case (2 x ww, 2 x cw, max 2 x 5 A and 4 x 2.5 A). The device can be operated, for example, with a Power DALI push-button control unit TW (1713 DSTE), or a KNX DALI gateway TW (2099 REGHE) from Jung, or with a DALI potentiometer Tunable WH (2030 00), or a KNX DALI gateway Tunable WH Plus (2108 00) from GIRA. The connected luminaires can be switched on or off and their color temperature can be changed and dimmed.

Dimensions: L 170 x W 54 x H 30 mm, ambient temperature (ta): 0 °C to +45 °C, measuring point (tc): maximum +70 °C, material: Plastic

Item no.	Description	Price €
18151000	KNX system prerequisite: at least ETS 4.0F or higher.	412.00
18152000	DALI (DT6)	121.90
18153000	DMX	104.90
18154000	1-10 V	103.80
18155000	DALI (DT8) TunableWhite	126.10





REG LED dimmer 12-24 V DC, dimmable

LED dimmer series for constant voltage operation (12-24 V DC) using 4 channels (single or multi-color). Wiring is carried out via plug-in terminals without using screws. Line cross-section: 0.5-2.5 mm².

An external power supply is required for operation, output signal (dimming): PWM (pulse width modulation), with reverse polarity and overtemperature protection.

Maximum output current: 10 A (4 x 2.5 A; 3 x 3.33 A; 2 x 5 A; 1 x 5 A)
 Maximum output power 12 V: 120 W (4 x 30 W; 3 x 40 W; 2 x 60 W; 1 x 60 W)
 Maximum output power 24 V: 240 W (4 x 60 W; 3 x 80 W; 2 x 120 W; 1 x 120 W)

18161000: 4-channel device with a maximum of 4 addresses (KNX). One address is assigned to each channel (output).

The KNX dimmer can be used for monochrome, RGB and RGBW luminaires. KNX certified device, can be configured using the ETS software (4.0F or higher). The system application and the KNXPROD file in German can be downloaded from www.brumberg.com. Functions / objects: Switching, relative dimming, absolute dimming, preset, scenes, color sequences, two pre-programmed color gradients, etc.

18162000: 1 to 4-channel device with 1-4 addresses (DALI). Channels (outputs) can be combined with 1, 2, 3 or 4 addresses. As an alternative to DALI, the 4 channels (outputs) can be controlled (dimmed) simultaneously, i.e. all four channels behave in the same way, using a pushbutton (push-dimm, switch-dimm).

18163000: 1 to 4-channel device with 1-4 addresses (DMX). Channels (outputs) can be combined with 1, 2, 3 or 4 addresses.

18164000: 1 to 4-channel device with a maximum of 4 x 1-10 V inputs. The inputs can be combined with each other.

18165000: 2 x 2-channel device with one address (DALI DT8) for TunableWhite luminaires. Two channels (outputs) are combined in each case (2 x ww, 2 x cw, max 2 x 5 A and 4 x 2.5 A). The device can be operated, for example, with a Power DALI push-button control unit TW (1713 DSTE), or a KNX DALI gateway TW (2099 REGHE) from Jung, or with a DALI potentiometer Tunable WH (2030 00), or a KNX DALI gateway Tunable WH Plus (2108 00) from GIRA. The connected luminaires can be switched on or off and their color temperature can be changed and dimmed. (L 54 x W 110 x H 66 mm, 3 TE).

Ambient temperature (ta): 0 °C to +45 °C,
 Measuring point (tc): maximum +75 °C, material: Plastic

Item no.	Description	Price €
18161000	KNX system prerequisite: at least ETS 4.0F or higher. Width: 4 TE	412.30
18162000	DALI (DT6) Width: 3 TE	121.90
18164000	1-10 V Width: 3TE	103.80
18165000	DALI (DT8) TunableWhite Width: 3TE	126.10





LED dimmer 12-24 V DC, dimmable ZigBee

ZigBee LED dimmer for constant voltage operation (12-24 V DC) using 5 channels. The device is adjustable for different operation modes.

- 5 x "single color" (not independent),
- 2 x "TunableWhite" (not independent),
- 1 x RGBW,
- 1 x RGB + TunableWhite

An external power supply is required for operation. The input and output terminals are suitable for lines with a cross-section of up to 1.5 mm².

- Input voltage: 12 – 24 V DC,
- Output voltage: depending on the input voltage (12-24 V DC),
- Output current: 4 A per channel,
- Output power: 48 W (12 V DC) – 96 W (24 V DC) per channel,
- Ambient temperature (ta): 0 °C to +45 °C,
- Measuring point (tc): maximum +75 °C,
- Including strain relief,
- Material: Plastic,
- Dimensions: L 145 x W 46.5 x H 16 mm,
- Frequency: 2.4 GHz, protocol: ZigBee 3.0

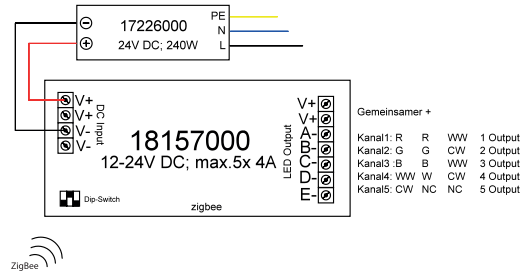

Item no.	Description	Price €
18157000	ZigBee 3.0	103.80

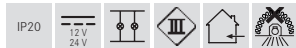



ZigBee LED radio remote control for 18157000

ZigBee LED radio control for ZigBee LED dimmer 18157000

Allows pairing ZigBee lighting devices via touchlink commissioning.

Supports search and bind mode for pairing with ZigBee lighting devices.

Allows to bind and control universal DIM, CCT, RGB, RGBW and RGB + CCT ZigBee lighting devices

Transmission range (line-of-sight): up to 30 m.

Up to four groups (maximum 30 receivers) can be controlled independently with one remote control. Seven individual colors and brightnesses can be stored and recalled.

Six preset scenes and five color temperatures can be recalled. Adjustment of RGB color saturation possible.

Voltage (battery): 6 V DC - 2 x CR2032 (not included in the scope of delivery)

Frequency: 2.4 GHz, transmission power (Ps) < 0 dBm, protocol: ZigBee 3.0, Dimensions: L 137 x W 45 x H 13 mm, material: Plastic

Item no.	Price €
18207000	103.80

IP20



Private house, Norderstedt



LED dimmer 24 V DC, DALI-, 1-10 V-, PUSH dimmable

LED dimmer single channel (single color) for constant voltage operation (24 V DC). Wiring is carried out via plug-in terminals. Line cross-section: 0.5 - 2.5 mm². An external power supply is required for operation. Output signal (dimming): PWM (pulse width modulation). With overload, short-circuit, overtemperature and no-load protection, maximum output current: 5 A.

The device can be controlled via DALI or a push-button (push-dim) or 1-10 V. Several devices can be operated as master/slave to extend the output.

Dimensions: L 153 x W 30 x H 21 mm without strain relief. L 184 x W 35 x H 24 mm with strain relief, input voltage: 24 V DC, control unit: DALI, 1-10 V, DALI/PUSH, dimming range 1-100%, ambient temperature (ta): -20 °C to +40 °C, measuring point (tc): maximum +55 °C, material: Plastic

You will find corresponding 24 V power supplies from page 532 onwards.



TunableWhite LED dimmer 12-24 V DC, 2 x 1-10 V

Two-channel LED dimmer (single or two-color) for constant voltage operation (12-24 V DC). Wiring is carried out via screw terminals. Line cross-section: 0.5 - 2.5 mm². An external power supply is required for operation.

Output signal (dimming): PWM (pulse width modulation). With overload and short circuit protection, maximum output power: 2 x 192 W.

The device can use two 1-10 V signals to dim either two independent groups of luminaires, or to change the color temperature and dim a TunableWhite group.

Dimensions: L 167 x W 51 x H 23 mm, input voltage: 12-24 V DC, control unit: 1-10 V, ambient temperature (ta): -20 °C to +50 °C, measuring point (tc): maximum +75 °C, material: Plastic

You will find corresponding 12 / 24 V power supplies from page 530/532 onwards.

Item no.	Secondary voltage	Power	Price €
17502000	24 V	0-120 W	99.70



Item no.	Price €
18156000	219.00

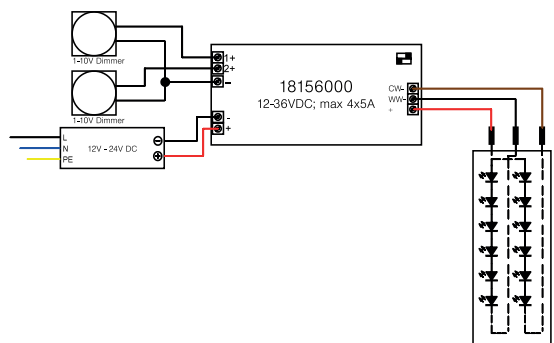
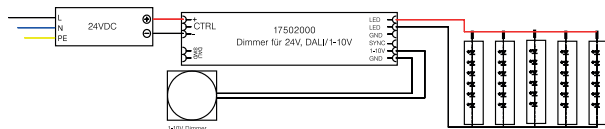





White light radio controller

White light radio control for controlling single color LED modules in the white light range or for controlling dim2warm flex boards 15312003 / 15362003.

Controller:

Voltage: 12-24 V DC,
 Current: maximum 10 A (2 x 5 A or 3 x 3.33 A),
 Power: maximum 120 W / 240 W (12 V DC / 24 V DC),
 Control unit: negative (common anode),
 Control signal: PWM,
 Radio frequency: 869.5 MHz,
 Range (line-of-sight): up to 20 m,
 Ambient temperature (ta): 0 °C to +40 °C,
 Controller connection using screw terminals,
 Dimensions: L 178 x W 46 x H 18 mm,
 Material: Plastic, delivery: including strain relief,
 Controllers for each remote control: maximum 4 (in case of an optimum radio connection)

Remote control:

Voltage (battery): 4.5 V DC - 3 x AAA (not included in the scope of delivery),
 Radio frequency: 869.5 MHz, transmission power (Ps) < 0 dBm,
 Range (line-of-sight): up to 20 m,
 Ambient temperature (ta): 0 °C to +40 °C,
 Dimensions: L 120 x W 48 x H 18 mm,
 Material: Plastic

Scope of function:

- On / Off
- Dimming using a touch wheel
- Save buttons S1 / S2
- Selector switches 25% / 50% / 75% / 100% brightness

You will find corresponding 12 / 24 V power supplies from page 530/532 onwards.

Item no.	Description	Price €
17528000	White light set (controller including remote control)	109.60
17511000	White light controller	52.80

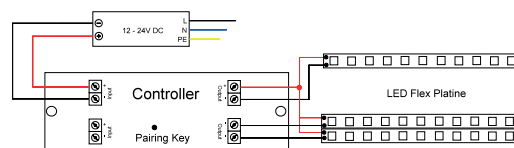
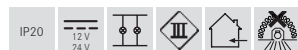



TunableWhite wireless technology control

TunableWhite remote control for controlling the two-color LED modules in the white light range.

Controller:

Voltage: 12-24 V DC,
 Current: maximum 2 x 5 A,
 Power: maximum 120 W / 240 W (12 V DC / 24 V DC),
 Control unit: negative (common anode),
 Control signal: PWM,
 Radio frequency: 869.5 MHz,
 Range (line-of-sight): up to 20 m,
 Ambient temperature (ta): 0 °C to +40 °C,
 Controller connection using screw terminals,
 Dimensions: L 178 x W 46 x H 18 mm,
 Material: Plastic, delivery: including strain relief,
 Controllers for each remote control: maximum 4 (in case of an optimum radio connection)

Remote control:

Voltage (battery): 4.5 V DC - 3 x AAA (not included in the scope of delivery),
 Radio frequency: 869.5 MHz, transmission power (Ps) < 0 dBm,
 Range (line-of-sight): up to 20 m,
 Ambient temperature (ta): 0 °C to +40 °C,
 Dimensions: L 120 x W 48 x H 18 mm,
 Material: Plastic

Scope of function:

- On / Off
- Light color change using a touch wheel
- Dimming of the set light color
- Save buttons S1 / S2
- Selector switches 25% / 50% / 75% / 100% brightness

You will find corresponding 12 / 24 V power supplies from page 530/532 onwards.

Item no.	Description	Price €
17518000	TunableWhite set (controller including remote control)	108.60
17511000	TunableWhite controller	52.80

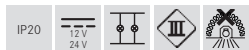
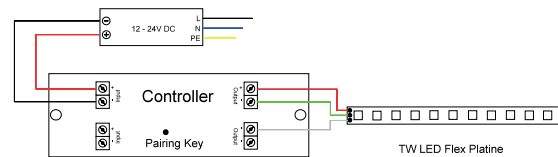



RGB wireless technology control

RGB radio controller for controlling RGB LED modules in the color light range.

Controller:

Voltage: 12-24 V DC,
 Current: maximum 3 x 3.33 A,
 Power: maximum 120 W / 240 W (12 V DC / 24 V DC),
 Control unit: negative (common anode),
 Control signal: PWM,
 Radio frequency: 869.5 MHz,
 Range (line-of-sight): up to 20 m,
 Ambient temperature (ta): 0 °C to +40 °C,
 Controller connection using screw terminals,
 Dimensions: L 178 x W 46 x H 18 mm,
 Material: Plastic, delivery: including strain relief,
 Controllers for each remote control: maximum 4 (in case of an optimum radio connection)

Remote control:

Voltage (battery): 4.5 V DC - 3 x AAA (not included in the scope of delivery),
 Radio frequency: 869.5 MHz, transmission power (Ps) < 0 dBm,
 Range (line-of-sight): up to 20 m,
 Ambient temperature (ta): 0 °C to +40 °C,
 Dimensions: L 120 x W 48 x H 18 mm,
 Material: Plastic

Scope of function:

- On / Off
- RGB color change using a touch wheel
- Dimmer switch for red / green / blue
- Color ramp: Start / Stop
- Color ramp: Speed

You will find corresponding 12 / 24 V power supplies from page 530/532 onwards.

Item no.	Description	Price €
18233000	RGB set (controller including remote control)	108.70
17511000	RGB controller	52.80

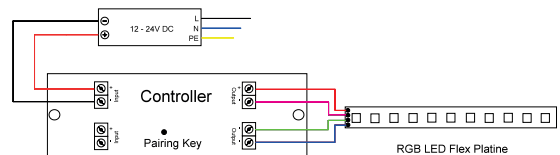
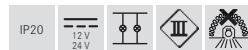



RGBW wireless technology control

RGBW radio controller for controlling the RGBW LED modules in colored and white light.

Controller:

Voltage: 12-24 V DC,
 Current: maximum 4 x 2.5 A,
 Power: maximum 120 W / 240 W (12 V DC / 24 V DC),
 Control unit: negative (common anode),
 Control signal: PWM,
 Radio frequency: 869.5 MHz,
 Range (line-of-sight): up to 20 m,
 Ambient temperature (ta): 0 °C to +40 °C,
 Controller connection using screw terminals,
 Dimensions: L 178 x W 46 x H 18 mm,
 Material: Plastic, delivery: including strain relief,
 Controllers for each remote control: maximum 4 (in case of an optimum radio connection)

Remote control:

Voltage (battery): 4.5 V DC - 3 x AAA (not included in the scope of delivery),
 Radio frequency: 869.5 MHz, transmission power (Ps) < 0 dBm,
 Range (line-of-sight): up to 20 m,
 Ambient temperature (ta): 0 °C to +40 °C,
 Dimensions: L 120 x W 48 x H 18 mm,
 Material: Plastic

Scope of function:

- On / Off
- White light selector switch (ww / nw / w)
- RGB color change using a touch wheel
- Dimmer switch for red / green / blue / white
- Dimming of the set light color
- Save buttons S1 / S2
- Color ramp: Start / Stop
- Color ramp: Speed

You will find corresponding 12 / 24 V power supplies from page 530/532 onwards.

Item no.	Description	Price €
18223000	RGBW set (controller including remote control)	119.70
18220000	RGBW controller	60.50

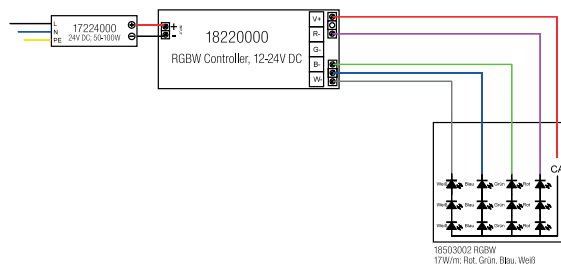
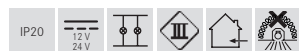



Radio system controller for 1 to 4-channel operation

Universal radio system controller for controlling the 1 to 4-channel LED modules.

Possible control variants:

White light, TunableWhite, RGB, RGBW

Compatible with:

White light remote control: 18199000, 18202000,
TunableWhite remote control: 18198000, 18201000,
RGB remote control: 18197000, 18200000,
RGBW remote control: 18196000, 18194070 and 18194080.

For other functions of the aforementioned components, please refer to the respective product description.

Radio master controller for 18192000:

Voltage: 12-24 V DC,
Current: maximum 4 x 2.5 A,
Power: maximum 120 W / 240 W (12 V DC / 24 V DC),
Control unit: negative (common anode),
Control signal: PWM,
Radio frequency: 869.5 MHz,
Range (line-of-sight): up to 20 m,
Ambient temperature (ta): 0 °C to +40 °C,
Controller connection using screw terminals,
Dimensions: L 160 x W 45 x H 18 mm,
Material: Plastic, delivery: including strain relief,
Controllers for each remote control: maximum 4 (in case of an optimum radio connection)

Controller for system extension: 18195000 (wired):

Voltage: 12-24 V DC,
Current: maximum 4 x 2.5 A,
Power: maximum 120 W / 240 W (12 V DC / 24 V DC),
Control unit: negative (common anode),
Control signal: PWM,
Ambient temperature (ta): 0 °C to +40 °C,
Controller connection using screw terminals,
Dimensions: L 160 x W 45 x H 18 mm,
Material: Plastic, delivery: including strain relief

You will find corresponding 12 / 24 V power supplies from page 530/532 onwards.

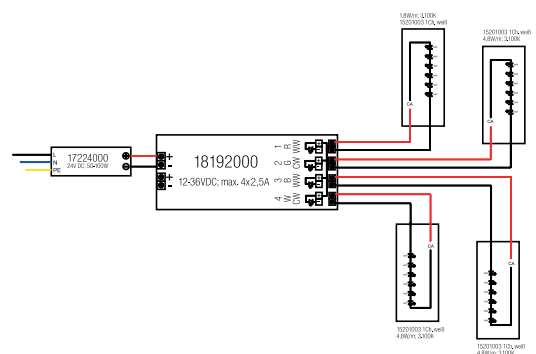

Item no.	Description	Price €
18192000	Radio master controller	136.70
18195000	Controller for system extension, wired	73.10





White light radio remote control for 18192000

White light radio remote control for controlling single color LED modules in the white light range or for controlling dim2warm flex boards 15312003 / 15362003.

Voltage (battery): 4.5 V DC - 3 x AAA (not included in the scope of delivery),
 Radio frequency: 869.5 MHz, transmission power (Ps) < 0 dBm,
 Range (line-of-sight): up to 20 m,
 Ambient temperature (ta): 0 °C to +40 °C,
 Dimensions: L 140 x W 48 x H 17 mm,
 Material: Plastic, delivery: including wall bracket

Scope of function:

- On / Off
- Dimming using a touch wheel
- Save buttons S1 to S6
- Selector switches 25% / 50% / 75% / 100% brightness
- Controller selector switches for zones 1 to 6

Compatible with the radio master controller 18192000; for additional functions, please refer to the product description.



White light table remote control for 18192000

White light table remote control for controlling single color LED modules in the white light range or for controlling dim2warm flex boards 15312003 / 15362003.

Voltage (battery): 3 V DC - 1 x CR2025 (not included in the scope of delivery),
 Radio frequency: 869.5 MHz, transmission power (Ps) < 0 dBm,
 Range (line-of-sight): up to 20 m,
 Ambient temperature (ta): 0 °C to +40 °C,
 Dimensions: L 96 x W 65 x H 74 mm,
 Material: Plastic

Scope of function:

- On / Off
- Dimming using a rotary dimmer

Compatible with the radio master controller 18192000; for additional functions, please refer to the product description.

Item no.	Price €
18199000	115.50

IP20

Item no.	Price €
18202000	83.70

IP20

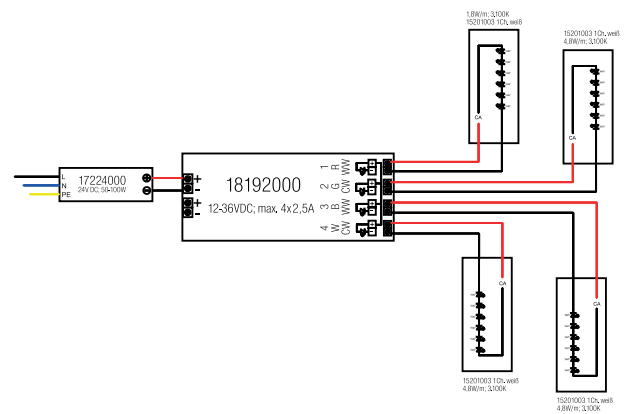
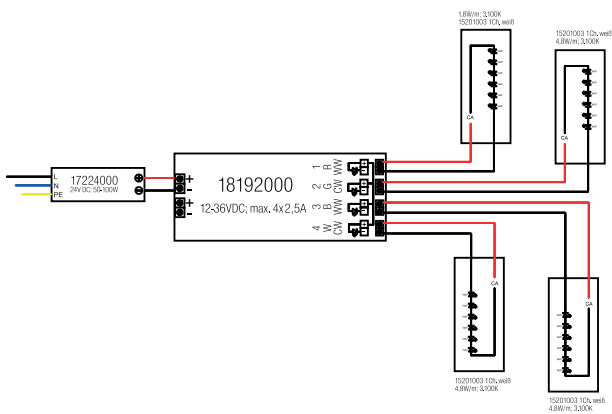



TunableWhite radio remote control for 18192000

TunableWhite radio remote control for controlling the two-color LED modules in the white light range.

Voltage (battery): 4.5 V DC - 3 x AAA (not included in the scope of delivery),
 Radio frequency: 869.5 MHz, transmission power (Ps) < 0 dBm,
 Range (line-of-sight): up to 20 m,
 Ambient temperature (ta): 0 °C to +40 °C,
 Dimensions: L 140 x W 48 x H 17 mm,
 Material: Plastic, delivery: including wall bracket

Scope of function:

- On / Off
- Light color change using a touch wheel
- Dimming of the set light color
- Save buttons S1 to S6
- Selector switches 25% / 50% / 75% / 100% brightness
- Controller selector switches for zones 1 to 6

Compatible with the radio master controller 18192000; for additional functions, please refer to the product description.

Item no.	Price €
18198000	126.10

IP20



TunableWhite table remote control 18192000

TunableWhite table remote control for controlling the two-color LED modules in the white light range.

Voltage (battery): 3 V DC - 1 x CR2025 (not included in the scope of delivery),
 Radio frequency: 869.5 MHz, transmission power (Ps) < 0 dBm,
 Range (line-of-sight): up to 20 m,
 Ambient temperature (ta): 0 °C to +40 °C,
 Dimensions: L 96 x W 65 x H 74 mm,
 Material: Plastic

Scope of function:

- On / Off
- Light color change using a rotary dimmer
- Dimming using a rotary dimmer

Compatible with the radio master controller 18192000; for additional functions, please refer to the product description.

Item no.	Price €
18201000	94.30

IP20

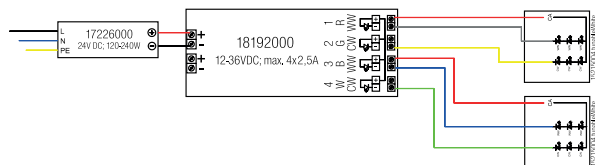
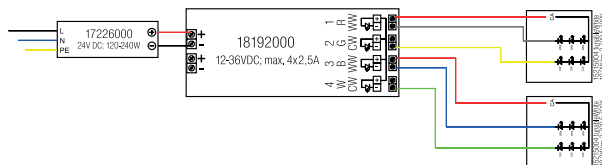



RGB radio remote control for 18192000

RGB radio remote control for controlling RGB LED modules in the color light range.

Voltage (battery): 4.5 V DC - 3 x AAA (not included in the scope of delivery),
 Radio frequency: 869.5 MHz, transmission power (Ps) < 0 dBm,
 Range (line-of-sight): up to 20 m,
 Ambient temperature (ta): 0 °C to +40 °C,
 Dimensions: L 140 x W 48 x H 17 mm,
 Material: Plastic, delivery: including wall bracket

Scope of function:

- On / Off
- RGB color change using a touch wheel
- Dimmer switch for red / green / blue
- Color ramp: Start / Stop
- Color ramp: Speed
- Dimming of the set light color
- Save button S
- Controller selector switches for zones 1 to 6

Compatible with the radio master controller 18192000; for additional functions, please refer to the product description.



RGB table remote control for 18192000

RGB table remote control for controlling RGB LED modules in the color light range.

Voltage (battery): 3 V DC - 1 x CR2025 (not included in the scope of delivery),
 Radio frequency: 869.5 MHz, transmission power (Ps) < 0 dBm,
 Range (line-of-sight): up to 20 m,
 Ambient temperature (ta): 0 °C to +40 °C,
 Dimensions: L 96 x W 65 x H 74 mm,
 Material: Plastic

Scope of function:

- On / Off
- RGB color change using a rotary dimmer
- Dimming using a rotary dimmer

Compatible with the radio master controller 18192000; for additional functions, please refer to the product description.

Item no.	Price €
18197000	143.10

IP20

Item no.	Price €
18200000	94.30

IP20

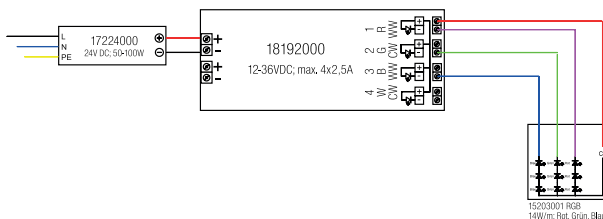
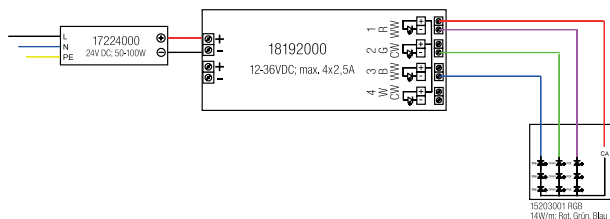



RGBW radio remote control for 18192000

RGBW radio remote control for controlling the RGBW LED modules in colored and white light.

Voltage (battery): 4.5 V DC - 3 x AAA (not included in the scope of delivery),
 Radio frequency: 869.5 MHz, transmission power (Ps) < 0 dBm,
 Range (line-of-sight): up to 20 m,
 Ambient temperature (ta): 0 °C to +40 °C,
 Dimensions: L 152 x W 52 x H 19 mm,
 Material: Plastic, delivery: including wall bracket

Scope of function:

- On / Off
- RGB color change using a touch wheel
- White light selector switch (ww / nw / w)
- Dimmer switch for red / green / blue / white
- Color ramp: Start / Stop
- Color ramp: Speed
- Dimming of the set light color using touch field
- Save button S1 to S4
- Controller selector switches for zones 1 to 4

Compatible with the radio master controller 18192000; for additional functions, please refer to the product description.



RGBW radio wall panel for 18192000

RGBW radio wall panel for controlling the RGBW LED modules in colored and white light.

Rated voltage: 110-230 V AC 50 Hz,
 Current consumption: 15 mA,
 Radio frequency: 869.5 MHz, transmission power (Ps) < 0 dBm,
 Range (line-of-sight): up to 20 m,
 Ambient temperature (ta): 0 °C to +40 °C,
 Connection using screw terminals,
 Mounting in device socket (flush-mounted),
 Installation depth in device socket: 20 mm,
 Outer dimensions: L 86 x W 86 x D 12 mm,
 Material: Glass / Plastic,
 Controllers for each wall panel: maximum 4 (in case of an optimum radio connection)

Scope of function:

- On / Off
- RGB color change using a touch wheel
- Dimmer switch for red / green / blue / white
- Dimming of the set light color
- Save button S
- Color ramp: Start / Stop
- Color ramp: Speed

Compatible with the radio master controller 18192000; for additional functions, please refer to the product description.

Item no.	Price €
18196000	157.90

IP20

Item no.	Color	Price €
18194070	White	147.30
18194080	Black	147.30

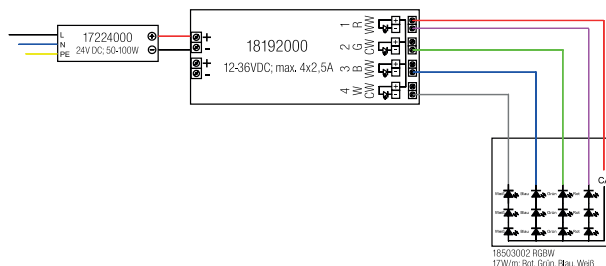
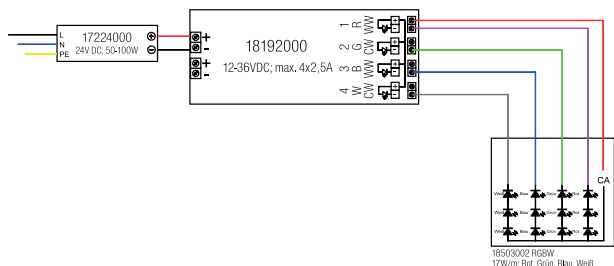



Radio system controller for 1 to 5-channel operation

NEW

Universal radio system controller for controlling the 1 to 5-channel LED modules.

Possible control variants:
RGB + TunableWhite

Radio master controller for 18190000:
Voltage: 12-24 V DC,
Current: maximum 5 x 2.0 A, 4 x 2.5 A, 3 x 3.33 A, 2 x 5.0 A, 1 x 5.0 A,
Power: maximum 120 W / 240 W (12 V DC / 24 V DC),
Control unit: negative (common anode),
Control signal: PWM,
Radio frequency: 869.5 MHz,
Range (line-of-sight): up to 20 m,
Ambient temperature (ta): 0 °C to +40 °C,
Dimensions: L 170 x W 59 x H 29 mm,
Material: Plastic, delivery: including strain relief,
Controllers for each remote control: maximum 4 (in case of an optimum radio connection)

Compatible with:
RGB + TW remote control: 18205000
For other functions of the aforementioned components, please refer to the respective product description.

You will find corresponding 12 / 24 V power supplies from page 530/532 onwards.

Item no.	Description	Price €
18190000	NEW 5-channel controller	159.00

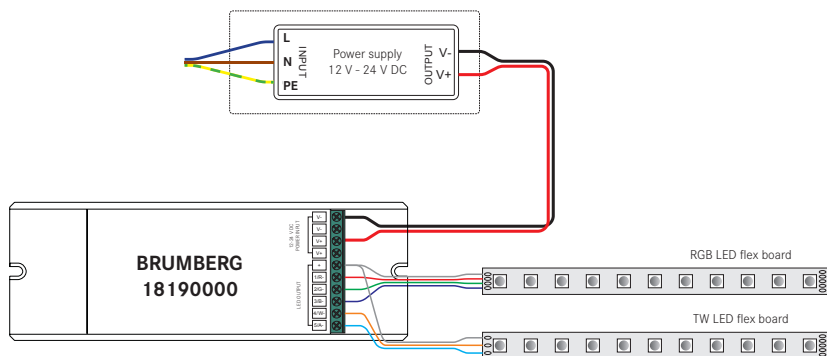
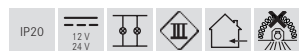



RGB-TW remote control for 18190000

NEW

RGB+TW remote control for controlling the 5-channel LED modules with RGB and TunableWhite.

Voltage (battery): 4.5 V DC - 3 x AAA
 (not included in the scope of delivery),
 Radio frequency: 869.5 MHz, transmission power (Ps) < 0 dBm,
 Range (line-of-sight): up to 20 m,
 Ambient temperature (ta): 0 °C to +40 °C,
 Dimensions: L 153 x W 52 x H 19 mm,
 Material: Plastic, delivery: including wall bracket

Scope of function:

- On / Off
- RGB+TW color change using a touch wheel and slider
- White light selector switch (ww / nw / w)
- Dimmer switch for red / green / blue / white
- Color ramp: Start / Stop
- Color ramp: Speed
- Dimming of the set light color using touch field
- Save button S1 to S4
- Controller selector switches for zones 1 to 4

Compatible with the radio master controller 18190000; for additional functions, please refer to the product description.

Item no.		Price €
18205000	NEW	175.00

IP20



Bracket with holder GX5.3, with strain relief

For **spring fastening** with 2-pin plug-in terminal 2 x 2.5 mm² and strain relief.

Model: GX5.3, material: Steel / Plastic / Ceramic

Item no.	Price €
536600	4.20

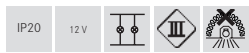

Bracket with holder GX5.3, with strain relief

For **plug-in fastening** with 2-pin plug-in terminal 2 x 2.5 mm² and strain relief.

Model: GX5.3, material: Steel / Plastic / Ceramic

Item no.	Price €
536400	4.20

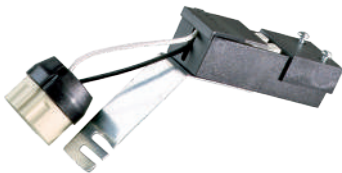
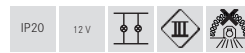

Bracket with holder GZ10, with strain relief

For **spring fastening** with 2-pin plug-in terminal 2 x 2.5 mm² and strain relief.

Model: GZ10, material: Steel / Plastic / Ceramic

Item no.	Price €
535800	11.50

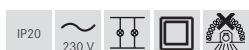

Bracket with holder GZ10, with strain relief

For **plug-in fastening** with 2-pin plug-in terminal 2 x 2.5 mm² and strain relief.

Model: GZ10, material: Steel / Plastic / Ceramic

Item no.	Price €
535900	11.50

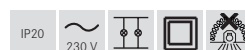



Holder GU10

Holder GU10 QPAR51 (luminaire half) with feed line 130 mm.
Without strain relief.*

Model: GU10, material: Plastic / Ceramic

Item no.	Price €
535500	5.30

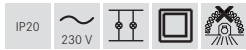

* Note: On-site strain and shear relief must be provided!



6-fold, low-voltage AMP distributor

6-fold AMP distributor.
Suitable for 12 V lighting systems (AC).

Item no.	Description	Price €
536100	6-fold AMP distributor	13.30

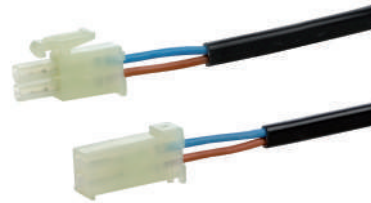

Low-voltage AMP line

AMP line with plug and coupling.
Suitable for 12 V lighting systems (AC).

Item no.	Description	Price €
536500	Length: 2,000 mm	8.40

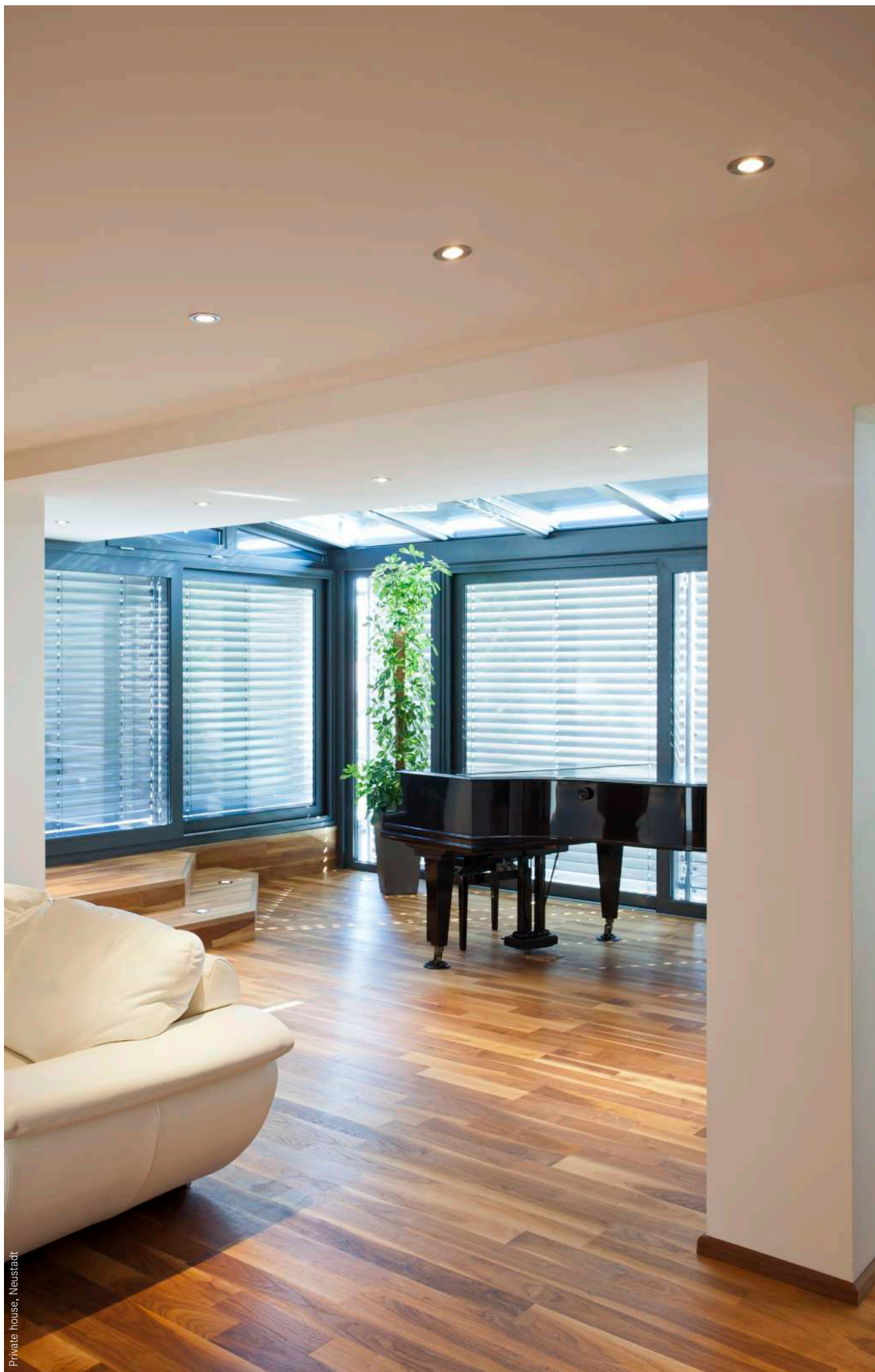

Private house, Neustadt

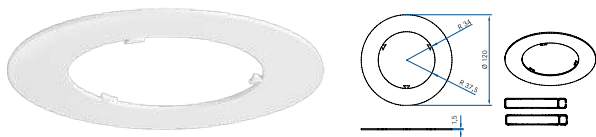

Reduction ring 120 mm

Reduction ring is suitable for recessed spotlights with mounting springs
Outer diameter 120 mm (suitable for on-site ceiling cut-outs of up to 110 mm), inner diameter 68 or 74 mm (can be changed to 74 mm on the site)

Scope of delivery: 1x reduction ring including 1 set spring extension
Material: Aluminum

Item no.	Color	Price €
81004020	Chromium	55.10
81004070	White	29.90
81004080	Black	29.90
81004150	Nickel matte	59.90



Reduction ring 150 mm

Reduction ring is suitable for recessed spotlights with mounting springs
Outer diameter 150 mm (suitable for on-site ceiling cut-outs of up to 140 mm), inner diameter 68 or 74 mm (can be changed to 74 mm on the site)

Scope of delivery: 1x reduction ring including 1 set spring extension
Material: Aluminum

Item no.	Color	Price €
81005020	Chromium	65.90
81005070	White	32.00
81005080	Black	32.00
81005150	Nickel matte	82.90

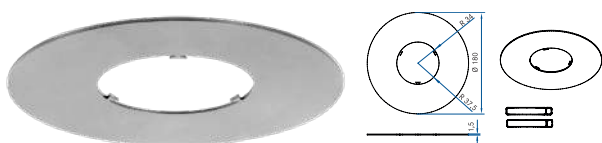

Reduction ring 180 mm

Reduction ring is suitable for recessed spotlights with mounting springs
Outer diameter 180 mm (suitable for on-site ceiling cut-outs of up to 170 mm), inner diameter 68 or 74 mm (can be changed to 74 mm on the site)

Scope of delivery: 1x reduction ring including 1 set spring extension
Material: Aluminum

Item no.	Color	Price €
81006020	Chromium	76.00
81006070	White	34.90
81006080	Black	34.90
81006150	Nickel matte	99.90

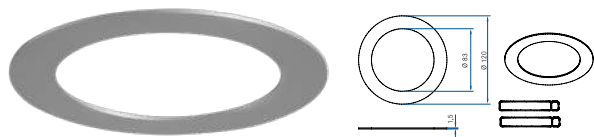

Reduction ring 120 mm

Reduction ring is suitable for recessed spotlights with mounting springs
Outer diameter 120 mm (suitable for on-site ceiling cut-outs of up to 110 mm), inner diameter 83 mm

Scope of delivery: 1x reduction ring including 1 set spring extension
Material: Aluminum

Item no.	Color	Price €
81007020	Chromium	55.10
81007070	White	29.90
81007080	Black	29.90
81007150	Nickel matte	59.90



Reduction ring 150 mm

Reduction ring is suitable for recessed spotlights with mounting springs
Outer diameter 150 mm (suitable for on-site ceiling cut-outs of up to 140 mm), inner diameter 83 mm

Scope of delivery: 1x reduction ring including 1 set spring extension
Material: Aluminum

Item no.	Color	Price €
81008020	Chromium	65.50
81008070	White	32.00
81008080	Black	32.00
81008150	Nickel matte	64.90

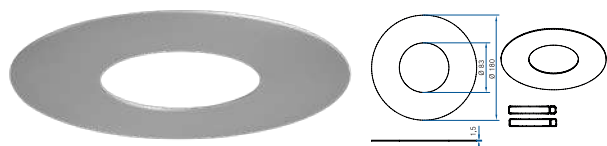

Reduction ring 180 mm

Reduction ring is suitable for recessed spotlights with mounting springs
Outer diameter 180 mm (suitable for on-site ceiling cut-outs of up to 170 mm), inner diameter 83 mm

Scope of delivery: 1x reduction ring including 1 set spring extension
Material: Aluminum

Item no.	Color	Price €
81009020	Chromium	76.00
81009070	White	34.90
81009080	Black	34.90
81009150	Nickel matte	73.90

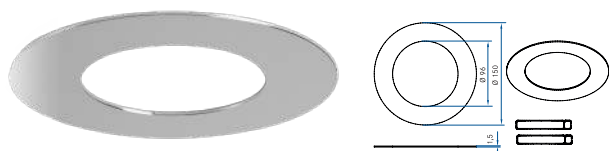

Reduction ring 150 mm

Reduction ring is suitable for recessed spotlights with mounting springs
Outer diameter 150 mm (suitable for on-site ceiling cut-outs of up to 140 mm), inner diameter 96 mm

Scope of delivery: 1x reduction ring including 1 set spring extension
Material: Aluminum

Item no.	Color	Price €
81014020	Chromium	65.90
81014070	White	32.00
81014080	Black	32.00
81014150	Nickel matte	64.90



Reduction ring 180 mm

Reduction ring is suitable for recessed spotlights with mounting springs
Outer diameter 180 mm (suitable for on-site ceiling cut-outs of up to 170 mm), inner diameter 96 mm

Scope of delivery: 1x reduction ring including 1 set spring extension
Material: Aluminum

Item no.	Color	Price €
81015020	Chromium	76.00
81015070	White	34.90
81015080	Black	34.90
81015150	Nickel matte	73.90

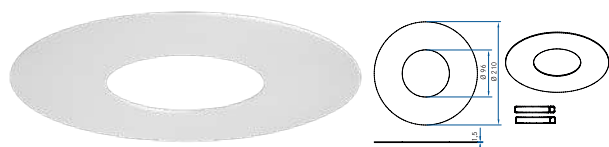

Reduction ring 210 mm

Reduction ring is suitable for recessed spotlights with mounting springs
Outer diameter 210 mm (suitable for on-site ceiling cut-outs of up to 200 mm), inner diameter 96 mm

Scope of delivery: 1x reduction ring including 1 set spring extension
Material: Aluminum

Item no.	Color	Price €
81016020	Chromium	85.00
81016070	White	38.90
81016080	Black	38.90
81016150	Nickel matte	83.90



Reduction ring for recessed luminaires

Standard reducing ring for recessed spotlights with outer diameter 84 - 87 mm, as adapter for ceiling cut-out 100 - 160 mm, diameter 180 mm, installation height 5 mm, suitable e.g. for Brumberg spotlights 1963... The final installation depth depends on the used recessed spotlight or the equipment of the luminaire. Mechanical installation depth without luminaire = 50 mm.

Material: Steel

Item no.	Color	Price €
81001070	White	32.90

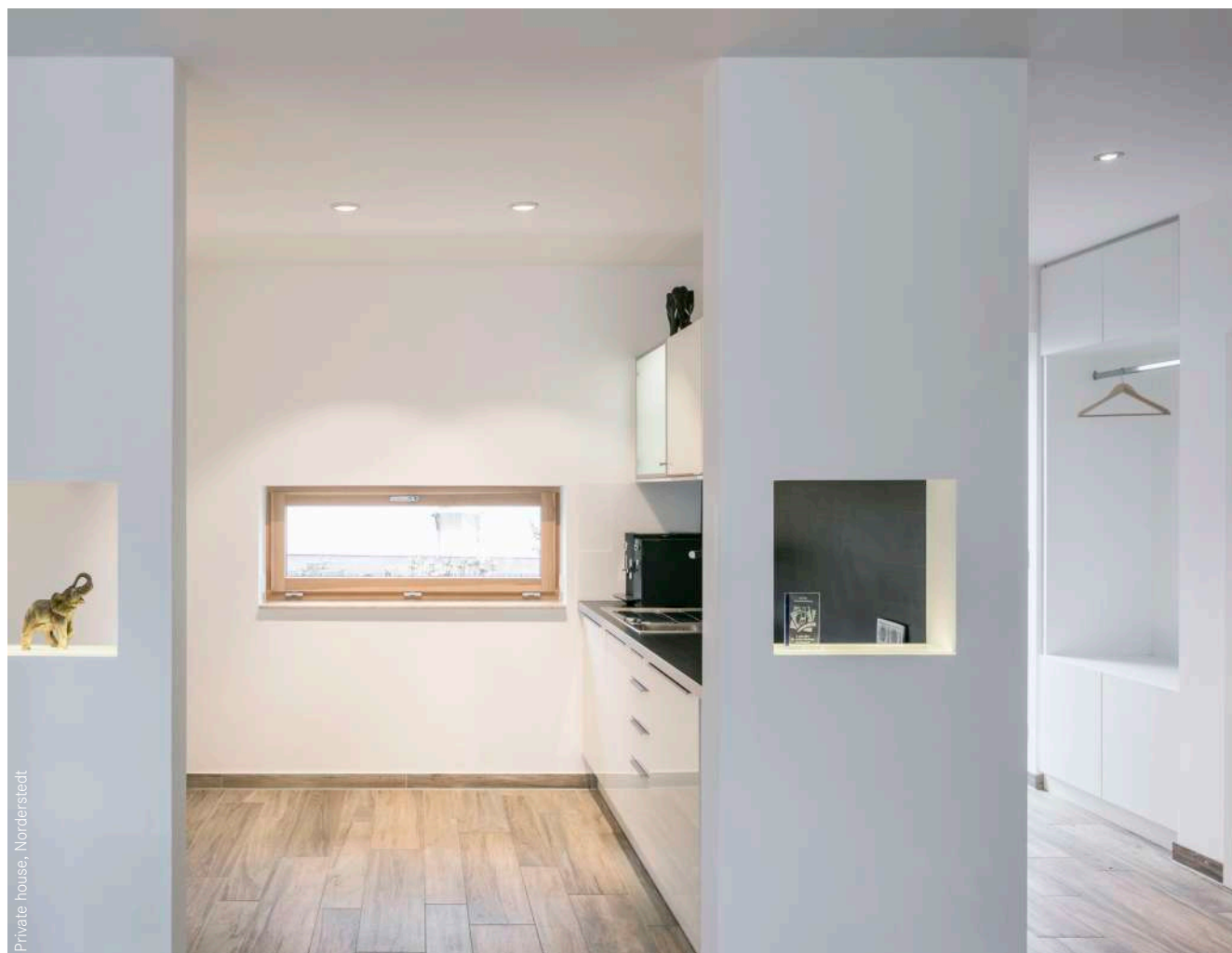



Mounting spring for recessed luminaires, short

Mounting spring for e.g. Kaiser flush-mounted/mounting housing
Possible for different spotlights on request.
Please send us your inquiry.

Material: Stainless steel
Quantity: 1 piece

Item no.	Price €
532500	1.50



Leaf spring for recessed luminaires

Mounting spring for e.g. Kaiser flush-mounted/mounting housing
Possible for different luminaires on request.

IMPORTANT: If your order refers to a previous inquiry, please inform us, so that your order can be executed accordingly!

Material: Stainless steel
Quantity: 1 piece

Item no.	Price €
532600	5.30



Item no.: 534700

Item no.: 534702

Item no.: 534701



Item no.: 534703

Item no.: 534704

Circlip Ø 51 mm for recessed luminaires for illuminant locking

GX5.3 / 51 mm

Item no.	Price €
534700	1.20
534702	1.20
534701	1.20
534703	1.20
534704	1.20

3

LED modules and accessories



21

Sales support.

Present the products successfully.

Sample case
Promotion presenter

Page 564
Page 566

Configurators
Catalogs / seminars

Page 568
Page 569



BRUMBERG

Das QualityFlex-Produktsystem. Für Indoor und Outdoor.
165 LED-Fluxplatten in 4 Klassen für 31 Profile.

Series	Accessories	Special Applications	Office
<ul style="list-style-type: none"> • 165x165, 165x200, 200x200, 400x400, 600x600, 800x800, 1200x1200 mm • 200, 250, 300, 350, 400, 450, 500, 600, 700, 800, 900, 1000 mm • 165, 200, 250, 300, 350, 400, 450, 500, 600, 700, 800, 900, 1000 mm • 165, 200, 250, 300, 350, 400, 450, 500, 600, 700, 800, 900, 1000 mm 	<ul style="list-style-type: none"> • 165x165, 165x200, 200x200, 400x400, 600x600, 800x800, 1200x1200 mm • 200, 250, 300, 350, 400, 450, 500, 600, 700, 800, 900, 1000 mm • 165, 200, 250, 300, 350, 400, 450, 500, 600, 700, 800, 900, 1000 mm • 165, 200, 250, 300, 350, 400, 450, 500, 600, 700, 800, 900, 1000 mm 	<ul style="list-style-type: none"> • 165x165, 165x200, 200x200, 400x400, 600x600, 800x800, 1200x1200 mm • 200, 250, 300, 350, 400, 450, 500, 600, 700, 800, 900, 1000 mm • 165, 200, 250, 300, 350, 400, 450, 500, 600, 700, 800, 900, 1000 mm • 165, 200, 250, 300, 350, 400, 450, 500, 600, 700, 800, 900, 1000 mm 	<ul style="list-style-type: none"> • 165x165, 165x200, 200x200, 400x400, 600x600, 800x800, 1200x1200 mm • 200, 250, 300, 350, 400, 450, 500, 600, 700, 800, 900, 1000 mm • 165, 200, 250, 300, 350, 400, 450, 500, 600, 700, 800, 900, 1000 mm • 165, 200, 250, 300, 350, 400, 450, 500, 600, 700, 800, 900, 1000 mm

Licht. Für Generationen.

1. QualityFlex Basic 165x165	165 x 165 x 25 mm	165 x 165 x 25 mm
2. QualityFlex Basic 165x200	165 x 200 x 25 mm	165 x 200 x 25 mm
3. QualityFlex Basic 200x200	200 x 200 x 25 mm	200 x 200 x 25 mm
4. QualityFlex Basic 400x400	400 x 400 x 25 mm	400 x 400 x 25 mm
5. QualityFlex Basic 600x600	600 x 600 x 25 mm	600 x 600 x 25 mm
6. QualityFlex Basic 800x800	800 x 800 x 25 mm	800 x 800 x 25 mm
7. QualityFlex Basic 1200x1200	1200 x 1200 x 25 mm	1200 x 1200 x 25 mm
8. QualityFlex Basic 165x165	165 x 165 x 25 mm	165 x 165 x 25 mm
9. QualityFlex Basic 165x200	165 x 200 x 25 mm	165 x 200 x 25 mm
10. QualityFlex Basic 200x200	200 x 200 x 25 mm	200 x 200 x 25 mm
11. QualityFlex Basic 400x400	400 x 400 x 25 mm	400 x 400 x 25 mm
12. QualityFlex Basic 600x600	600 x 600 x 25 mm	600 x 600 x 25 mm
13. QualityFlex Basic 800x800	800 x 800 x 25 mm	800 x 800 x 25 mm
14. QualityFlex Basic 1200x1200	1200 x 1200 x 25 mm	1200 x 1200 x 25 mm
15. QualityFlex Basic 165x165	165 x 165 x 25 mm	165 x 165 x 25 mm
16. QualityFlex Basic 165x200	165 x 200 x 25 mm	165 x 200 x 25 mm
17. QualityFlex Basic 200x200	200 x 200 x 25 mm	200 x 200 x 25 mm
18. QualityFlex Basic 400x400	400 x 400 x 25 mm	400 x 400 x 25 mm
19. QualityFlex Basic 600x600	600 x 600 x 25 mm	600 x 600 x 25 mm
20. QualityFlex Basic 800x800	800 x 800 x 25 mm	800 x 800 x 25 mm
21. QualityFlex Basic 1200x1200	1200 x 1200 x 25 mm	1200 x 1200 x 25 mm
22. QualityFlex Basic 165x165	165 x 165 x 25 mm	165 x 165 x 25 mm
23. QualityFlex Basic 165x200	165 x 200 x 25 mm	165 x 200 x 25 mm
24. QualityFlex Basic 200x200	200 x 200 x 25 mm	200 x 200 x 25 mm
25. QualityFlex Basic 400x400	400 x 400 x 25 mm	400 x 400 x 25 mm
26. QualityFlex Basic 600x600	600 x 600 x 25 mm	600 x 600 x 25 mm
27. QualityFlex Basic 800x800	800 x 800 x 25 mm	800 x 800 x 25 mm
28. QualityFlex Basic 1200x1200	1200 x 1200 x 25 mm	1200 x 1200 x 25 mm
29. QualityFlex Basic 165x165	165 x 165 x 25 mm	165 x 165 x 25 mm
30. QualityFlex Basic 165x200	165 x 200 x 25 mm	165 x 200 x 25 mm
31. QualityFlex Basic 200x200	200 x 200 x 25 mm	200 x 200 x 25 mm

www.brumberg.com

Promotion articles with premium quality

Impress your customers with your services and the Brumberg lighting solutions. We actively support you with professional presentation media with premium quality.

The presentation cases have a simple design and make the quality of Brumberg products tangible. A separate case is available for each Brumberg system. The luminaires can be removed (as far as technically possible) in order to demonstrate them in practical use at your customers' premises.

We will be happy to advise you.



QualityFlex aluminum profiles.

Profiles for recessed, surface-mounted and pendant solutions.

- For individual lighting solutions.
- Available in anodized aluminum, painted white or anodized black.
- Available in complete sets (1 m/2 m aluminum profile, end caps, brackets and covers).
- Individually as 2m profile or individually with the Brumberg assembly service, for safe project planning.

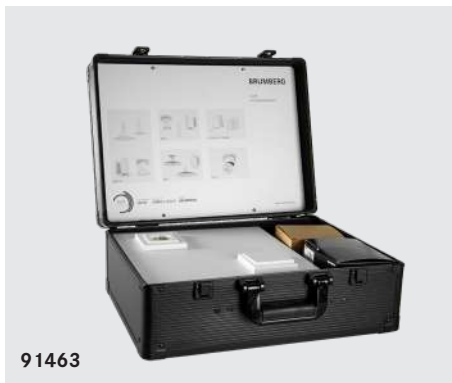

91463

Plug & Light.

Light socket for easy replacement of light attachments.

- Various luminaire families as ceiling-mounted, pendant and wall-mounted variants in a universal design.
- Simple and safe insertion of the luminaire by means of a magnet.
- Each luminaire can be rotated 360° without stops and can be replaced during operation.
- It can be inserted into any standard European flush-mounting socket.

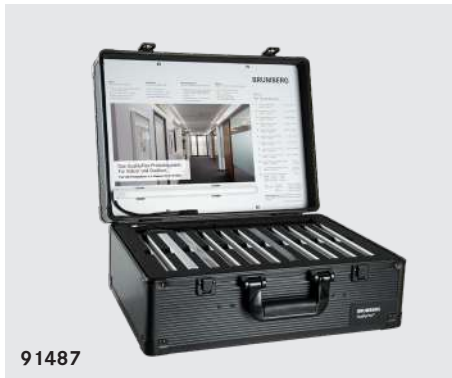

91487

QualityFlex. With LED flex boards Customized light design.

Wide range of lighting solutions with LED flex boards and matching profiles.

- 14 LED-flex boards pre-assembled in profiles for direct connection.
- 3 pattern covers (black, opal and transparent).
- 4 classes.



91471

Dim2warm and TunableWhite.

White light from 1800 Kelvin to 6500 Kelvin.

- Control the color temperature individually.
- Dim2warm: Warm white to feel good - from 3000 Kelvin to 1800 Kelvin.
- TunableWhite: White in all color temperatures from 2000 Kelvin to 6500 Kelvin.
- Coordinated luminaires from recessed spotlights to LED flex boards.



91479

BIRO40 Light channel system.

The most filigree light channel system from Brumberg.

- 40-mm wide, torsion-resistant aluminum profile.
- Available as recessed, surface-mounted or pendant luminaires.
- Individually configurable or available in standard lengths.
- Different geometries can be implemented.



91480

Module system M1.

In 4 steps to the individual luminaire.

- Customized design of recessed and surface-mounted luminaires.
- One to four-lamp housings are available.
- Uniform design in white or black.
- Compatible with up to 40 MR16 LED modules of Brumberg.

Promotion presenter. For the professional exhibition.

Light panels with recessed and surface-mounted luminaires for indoor and outdoor areas.

Surprising and, at the same time, reliable daylight has accompanied man since time immemorial. In the natural rhythm of life, it has dynamically shaped our sense of sight. Light always gives new images and releases emotions. It controls physical processes and influences the inner clock. Artificial light supports this naturally evolved interplay dynamically across space and time. It is unbelievable how much one can write about the effect of light. Experiencing light is quicker to understand and makes its meaning clear. With our presenters, you make light perceptible and your exhibition becomes an experience for your customers.

- Quick connection of the respective panels.
- 20 different options.
- For presentation as wall as well as tower possible.
- Always interchangeable.







Online configurators. Simple and fast.

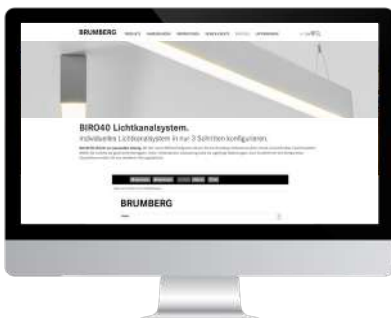

BIRO40 Light channel system.

Using the new BIRO40 light channel system configurator, you can put together your Brumberg light channel both quickly and with ease. First select the desired mounting type, color, color temperature, control and the corresponding cover. Special shapes can also be configured. Finally, you will get a detailed planning overview.

You can start your configuration now at: www.brumberg.com



QualityFlex.

With the LED-Stripes QualityFlex modular system, you can quickly find the right luminaires and accessories for any application. It is adjustable in length and can reproduce numerous colors. Thanks to its simple and versatile design, the illumination can be integrated into the entire architecture or only for individual pieces of furniture. Brumberg attaches particular importance to two aspects: unique technical quality and quickly implemented, individual solutions. The QualityFlex configurator allows you to plan your new indoor or outdoor solution with just a few clicks - pre-assembled and ready to install. With the finished planning PDF, orders can be processed particularly efficiently.

Catalogs. Know-how for professionals.



Project brochure.

More than just recessed spotlights. From private homes to large-scale projects.



Plan illumination.

For indoors and outdoors - from the driveway to the store room.



QualityFlex.

LED flex boards and profiles for basic and accent lighting.



Inspirations.

Lighting solutions for private homes and object illumination.

Brumberg seminars. Know-how for professionals.

The Brumberg Seminars and Events team takes care of imparting lighting knowledge to wholesalers, specialist trades, as well as architects and planners. The content of the training courses is always geared to the individual requirements of the respective target group and also takes into account the previous knowledge of the participants. Two topics are in particular focus:

- Basics, lighting technology and control units.
- Lighting concepts in the object-specific application.

The events take place either at the Brumberg plant or at the customer's site - depending on the customer's requirements. The promotion of junior staff is also an important component of the training courses. Brumberg has already had a network of selected brand partners for several years and thus offers the best possible knowledge transfer.

In addition, the products are coordinated with each other and guarantee smooth application. In addition to long-standing cooperation with Jung, Gira and Kaiser, Brumberg works closely with its neighbor Trilux on training courses, among other things. Because in order to keep up with digitalization and act in a future-oriented manner, customers must be given the opportunity to apply the knowledge that the market offers. Brumberg therefore enables you to work on the product in a practical way, expands cooperations, checks market developments and is in constant exchange with its partners.

Media library. Fast - compact - always at your service.

Here you will find product videos, along with on-demand trainings. We provide you with all information about our new products, services, software tools as well as practical tips on installation and the application areas of our luminaires.



Social media. The Brumberg community.



Click here to access Brumberg media library.

3

Appendix

Appendix.
Lighting technology.
For generations. 365 | 7 | 24.

About Brumberg

Page 572

Index

Page 574

GTC

Page 592

M1-matrix Surface mounted

Page 594

Color coding

Page 596

Pictograms / Protection classes

Page 597



The Brumberg fields of application.

Lighting technology. That connects people and spaces.

Thanks to our well thought-out luminaires and lighting concepts, we create living and working spaces in which people feel comfortable. In doing so, we attach great importance to functional diversity, state-of-the-art technology and energy efficiency. With this approach, we provide the right lighting solution for every application.



Office | Communication

Lighting technology. For productive work.

Light promotes creativity, supports productivity, awakens and ensures concentration. Glare-free luminaires are easy on the eyes of employees, and well thought-out lighting concepts ensure inspiring results during brainstorming sessions.



Shop | Retail

Lighting technology. Making products perceptible.

We recognize true colors of products only in the right light: Food stimulates the appetite and fashion creates its inspiring effect. Lively lighting scenarios are an integral part of the sales and store concept. Using suitable illumination, brands can optimally convey their image and the shopping trip becomes an experience for customers.



Home | Living

Lighting technology. To feel good.

With the right light, we create living spaces and make a house a home. In doing so, we always focus on people's requirements for the respective room. Activating in the morning and relaxing in the evening, lighting has a positive effect on the biorhythm.



Spa | Wellness

Lighting technology. It creates relaxing feeling.

The right lighting massages the senses and supports relaxation, whether in ice water or at 100 degrees Celcius. This makes us forget the stressful everyday life and helps us in recharging our batteries. In places where moisture and electricity meet, the luminaires deployed also need enhanced IP protection.



Hotel industry | Gastronomy

Lighting technology. For the home away from home.

Light lets us settle down and creates experiences of pleasure – just like at home. In well-lit rooms, people feel comfortable and welcome. This makes the hotel a temporary home and the restaurant a place of well-being for connoisseurs.

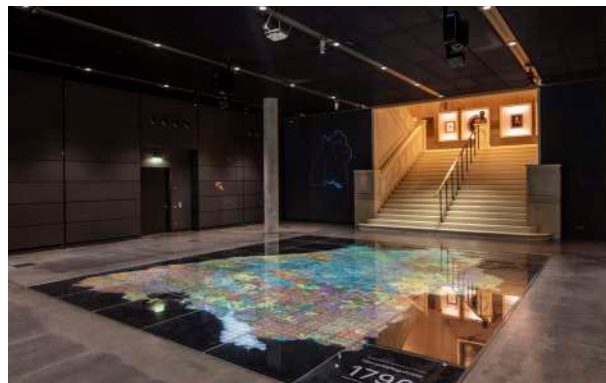

Education | Culture

Lighting technology. For lively learning environments.

In designing their exhibitions, modern museums rely on well thought-out lighting concepts that stage exhibits in an impressive manner. Images come alive, colors become tangible, history becomes an experience, and a connection between people and the exhibition is created. In educational institutions, lighting supports the different tasks of the learners. It thus promotes concentration and creativity. Lively learning landscapes emerge, knowledge is created.



Health | Care

Lighting technology. That makes people healthy.

The positive medical effect of light has now been proven by numerous studies. In the therapy of old or sick people, light becomes a health factor. Mental illnesses can also be treated with the help of light therapy. Therapeutically effective lighting concepts support the care and healing of patients in doctors' clinics, hospitals and other medical facilities.



Industry | Trade

Lighting technology. For safe working.

In industry and trade, lighting must provide one thing above all: Safety. In large industrial facilities, there are numerous sources of danger that can become a problem for employees and goods without appropriate lighting. With the right luminaires and lighting solutions for industry and trade, we ensure a motivating working environment in which people can safely go about their work.



Outdoor

Lighting technology. For long nights.

With friends on the terrace or relaxing by yourself on the balcony – no matter how you prefer to spend your soft summer nights: We have the perfect and standardized luminaires for each and every function and area of application. Because with the right lighting, the outdoor area becomes an experience.

Index

Item no.	Page	Price in €	Item no.	Page	Price in €	Item no.	Page	Price in €	Item no.	Page	Price in €
0063.02	40	21.00	10106103	478	180.10	1181.22	67 + 449	84.30	12076173	167	178.40
0063.07	40	19.90	10120103	472	125.00	12013073	248	129.90	12078073	157	59.40
0063.08	40	19.90	10121103	472	195.00	12013083	248	129.90	12078253	157	60.80
0063.25	40	19.90	10122173	237	135.60	12019073	248	149.90	12079023	151	57.20
0063.60	48	31.50	10122183	237	135.60	12019083	248	149.90	12079073	151	44.50
0063.62	48	31.50	10128203	215	124.10	12027153	158	59.90	12089003	145	145.00
0063.63	40	24.50	10129203	215	147.30	12035173	120	105.50	12089004	145	145.00
0063.64	40	24.50	10140203	216	132.80	12035174	120	105.50	12090073	159	39.00
0064.00	46	22.00	10141203	216	128.80	12035183	120	105.50	12090083	159	39.00
0065.02	42	23.50	10156073	212	104.90	12035184	120	105.50	12090623	159	39.00
0065.07	42	22.00	10156083	212	104.90	12035403	120	105.50	12093263	157	59.20
0065.08	42	22.00	10157073	212	104.90	12035404	120	105.50	12095263	157	37.40
0065.25	42	22.00	10157083	212	104.90	12035553	120	105.50	12109023	154	41.40
0065.63	42	27.00	10158073	213	104.90	12035554	120	105.50	12109153	154	41.40
0065.64	42	27.00	10158083	213	104.90	12035753	120	105.50	12110023	154	44.30
0066.00	47	27.00	10159073	213	104.90	12035754	120	105.50	12110153	154	44.30
0069.25	44	25.50	10159083	213	104.90	12035853	120	105.50	12111733	201	92.00
0070.25	45	28.00	10165253	218	89.90	12035854	120	105.50	12112733	201	92.00
0282.00	13	21.50	10166223	218	109.90	12036173	120	105.90	12114733	14	84.50
0283.00	13	27.20	10170183	470	92.50	12036174	120	105.90	12116073	11	102.10
10011223	217	150.80	10171183	470	96.50	12036183	120	105.90	12119173	198	88.00
10012223	217	147.30	10180073	239	105.00	12036184	120	105.90	12119183	198	88.00
10013103	475	278.40	10180083	239	105.00	12036403	120	105.90	12119823	198	99.00
10013173	475	278.40	10180723	239	115.60	12036404	120	105.90	12119893	198	99.00
10030173	471	109.70	10180823	239	115.60	12036553	120	105.90	12127023	155	53.20
10030183	471	109.70	10181073	241	105.00	12036554	120	105.90	12127153	155	53.20
10030693	471	109.70	10181083	241	105.00	12036753	120	105.90	12128023	155	59.00
10033103	475	299.60	10181723	241	115.60	12036754	120	105.90	12128153	155	59.00
10033173	475	299.60	10181823	241	115.60	12036853	120	105.90	12129023	156	59.90
10034173	471	117.40	10190073	239	136.80	12036854	120	105.90	12129153	156	59.90
10034183	471	117.40	10190083	239	136.80	12040173	165	230.00	12130023	156	65.70
10034693	471	117.40	10190723	239	147.40	12042173	165	218.00	12130153	156	65.70
10036183	228 + 473	111.00	10190823	239	147.40	12053173	149	74.50	12164023	158	45.40
10037183	229 + 473	121.50	10191073	241	136.80	12053183	149	74.50	12164073	158	45.40
10040173	224	306.20	10191083	241	136.80	12061073	178	225.00	12164083	158	45.40
10042173	224	306.20	10191723	241	147.40	12062173	178	155.00	12164153	158	45.40
10045173	227	197.40	10191823	241	147.40	12063173	178	125.00	12171153	158	239.90
10045253	227	197.40	10701173	222	229.90	12070253	149	29.70	12205073	143 + 195	45.40
10046173	227	219.00	10703173	222	254.90	12071023	149	34.70	12206073	143 + 195	63.50
10046253	227	219.00	10707173	221	199.90	12071073	149	33.90	12207073	143 + 195	94.90
10057173	218	139.80	10720173	221	254.90	12071253	149	34.70	12208073	163	150.60
10058173	218	143.50	10721173	221	254.90	12074183	167	190.00	12209073	163	200.40
10100733	227	74.00	1180.22	66 + 448	79.00	12075183	167	195.00	12215073	140	48.90

Item no.	Page	Price in €	Item no.	Page	Price in €	Item no.	Page	Price in €	Item no.	Page	Price in €
12215074	140	48.90	12293153	34	56.70	12362633	26	62.50	12385173	33	42.30
12215683	140	48.90	12293173	34	51.90	12362643	26	62.50	12385683	33	42.30
12215684	140	48.90	12293643	34	62.20	12366073	122	84.60	12391173	10	83.70
12217073	141	73.00	12295153	34	60.60	12371023	29	43.20	12392173	169	147.00
12217074	141	73.00	12295173	34	55.80	12371073	29	39.90	12393173	169	306.00
12217683	141	73.00	12295643	34	66.20	12371083	29	39.90	12394173	169	146.10
12217684	141	73.00	12307173	179	151.30	12371253	29	42.30	12395073	30	104.10
12219733	14	111.00	12307183	179	151.30	12371633	29	45.50	12395074	30	104.10
12225003	13	103.70	12308173	79	138.90	12371643	29	45.50	12395083	30	104.10
12226173	14	91.20	12308183	79	138.90	12373023	29	43.20	12395084	30	104.10
12227173	14	95.60	12309173	198	103.80	12373024	29	43.20	12395253	30	112.80
12245073	192	79.30	12309183	198	103.80	12373073	29	39.90	12395254	30	112.80
12246073	192	101.60	12310173	78	123.90	12373074	29	39.90	12396073	31	109.50
12249073	192	89.90	12310183	78	123.90	12373083	29	39.90	12396074	31	109.50
12250073	192	109.90	12321023	49	52.70	12373084	29	39.90	12396083	31	109.50
12261023	24	50.80	12321024	49	52.70	12373253	29	42.30	12396084	31	109.50
12261073	24	49.80	12321073	49	42.90	12373254	29	42.30	12401073	33	85.40
12261083	24	49.80	12321074	49	42.90	12373633	29	45.50	12406073	11	137.80
12261253	24	54.00	12321253	49	49.40	12373634	29	45.50	12407073	12	97.80
12261633	24	59.30	12321254	49	49.40	12373643	29	45.50	12408073	12	97.80
12261643	24	59.30	12353023	112	71.30	12373644	29	45.50	12415173	12	53.00
12262023	26	54.00	12353073	112	68.00	12374023	29	45.50	12417173	38	93.20
12262073	26	53.00	12353083	112	68.00	12374073	29	42.30	12418173	38	93.20
12262083	26	53.00	12353253	112	71.00	12374083	29	42.30	12419173	38	188.60
12262253	26	57.20	12353643	112	76.60	12374253	29	44.80	12420173	38	188.60
12262633	26	62.50	12355023	113	73.60	12374633	29	48.00	12423074	17	96.60
12262643	26	62.50	12355073	113	70.30	12374643	29	48.00	12424074	17	122.50
12266073	126	73.10	12355083	113	70.30	12376023	29	45.50	12425074	17	160.90
12266083	126	73.10	12355253	113	73.40	12376024	29	45.50	12435074	140	60.50
12267073	127	79.10	12355643	113	78.90	12376073	29	42.30	12435684	140	60.50
12267083	127	79.10	12361023	24	50.80	12376074	29	42.30	12437074	141	93.30
12270173	122	97.80	12361073	24	49.80	12376083	29	42.30	12437684	141	93.30
12270174	122	97.80	12361074	24	49.80	12376084	29	42.30	12443023	114	82.30
12270183	122	97.80	12361083	24	49.80	12376253	29	44.80	12443073	114	81.00
12270184	122	97.80	12361084	24	49.80	12376254	29	44.80	12443253	114	84.10
12276153	35	59.30	12361253	24	54.00	12376633	29	48.00	12443643	114	86.60
12276173	35	52.70	12361254	24	54.00	12376634	29	48.00	12444073	114	95.60
12277153	115	72.60	12361633	24	59.30	12376643	29	48.00	12444253	114	98.30
12277173	115	65.80	12361643	24	59.30	12376644	29	48.00	12445023	114	84.50
12286153	35	63.80	12362023	26	54.00	12383173	33	42.30	12445073	114	83.40
12286173	35	57.20	12362073	26	53.00	12383683	33	42.30	12445253	114	86.50
12287153	115	74.70	12362083	26	53.00	12384173	10	38.60	12445643	114	88.90
12287173	115	68.10	12362253	26	57.20	12384683	10	38.60	12446073	114	97.70

Index

Item no.	Page	Price in €	Item no.	Page	Price in €	Item no.	Page	Price in €	Item no.	Page	Price in €
12446253	114	100.40	12552183	21	199.00	12632073	92	79.90	12925004	506	37.90
12461073	28	64.60	12552184	21	199.00	12633073	93	94.90	12926003	506	37.90
12461253	28	69.10	12553173	21	239.00	12634073	92	94.90	12953003	507	84.60
12462073	28	67.90	12553174	21	239.00	12640073	91	64.90	12953004	507	84.60
12462253	28	72.40	12553183	21	239.00	12641073	93	79.90	12954003	507	84.60
12463153	34	67.00	12553184	21	239.00	12642073	92	79.90	12954004	507	84.60
12463173	34	62.10	12560173	20	79.00	12643073	93	94.90	12963383	506	61.10
12463643	34	73.10	12560174	20	79.00	12644073	92	94.90	12963603	506	61.10
12465153	34	71.00	12560183	20	79.00	12660223	137 + 457	306.20	12965003	507	97.80
12465173	34	66.10	12560184	20	79.00	12661223	137 + 457	279.90	12983003	508	99.20
12465643	34	77.00	12562173	20	129.00	12662223	137 + 457	378.60	13126173	39	80.20
12476153	35	72.40	12562174	20	129.00	12664223	137 + 457	449.90	13127173	39	84.50
12476173	35	65.50	12562183	20	129.00	12670223	139 + 459	306.20	13368073	123	87.50
12486153	35	77.70	12562184	20	129.00	12671223	139 + 459	279.90	13368153	123	91.10
12486173	35	71.00	12570173	20	99.00	12672223	139 + 459	395.00	13368683	123	87.50
12491073	30	107.40	12570174	20	99.00	12673223	139 + 459	338.00	13600163	204	529.90
12491083	30	107.40	12570183	20	99.00	12678223	138 + 458	361.10	13600164	204	529.90
12491253	30	116.20	12570184	20	99.00	12701173	173	217.30	13600173	204	529.90
12492073	31	112.80	12572173	20	139.00	12703173	173	251.40	13600174	204	529.90
12492083	31	112.80	12572174	20	139.00	12707173	173	295.30	13600183	204	529.90
12520073	18	47.50	12572183	20	139.00	12708173	178	217.30	13600184	204	529.90
12520074	18	47.50	12572184	20	139.00	12711173	203	262.30	13601163	204	629.90
12527073	19	49.60	12581173	84	149.00	12713173	203	262.30	13601164	204	629.90
12527074	19	49.60	12581174	84	149.00	12717173	203	306.20	13601173	204	629.90
12528073	19	67.90	12581183	84	149.00	12723173	203	273.30	13601174	204	629.90
12528074	19	67.90	12581184	84	149.00	12823003	508	88.00	13601183	204	629.90
12529073	19	98.40	12583173	84	229.00	12843004	508	139.00	13601184	204	629.90
12529074	19	98.40	12583174	84	229.00	12920003	509	32.30	13602163	204	1,079.00
12530073	18	48.50	12583183	84	229.00	12920004	509	32.30	13602164	204	1,079.00
12530074	18	48.50	12583184	84	229.00	12920183	509	32.30	13602173	204	1,079.00
12540073	22	77.00	12590173	82	149.00	12920184	509	32.30	13602174	204	1,079.00
12540074	22	77.00	12590174	82	149.00	12920243	509	32.30	13602183	204	1,079.00
12541073	22	89.00	12590183	82	149.00	12920244	509	32.30	13602184	204	1,079.00
12541074	22	89.00	12590184	82	149.00	12920603	509	32.30	13603163	204	1,380.00
12550173	21	129.00	12592173	82	229.00	12920604	509	32.30	13603164	204	1,380.00
12550174	21	129.00	12592174	82	229.00	12923383	506	51.80	13603173	204	1,380.00
12550183	21	129.00	12592183	82	229.00	12923384	506	51.80	13603174	204	1,380.00
12550184	21	129.00	12592184	82	229.00	12923603	506	51.80	13603183	204	1,380.00
12551173	21	169.00	12603173	37	107.60	12923604	506	51.80	13603184	204	1,380.00
12551174	21	169.00	12608173	37	107.60	12924383	506	51.80	13604163	204	1,829.00
12551183	21	169.00	12613173	37	207.50	12924384	506	51.80	13604164	204	1,829.00
12551184	21	169.00	12618173	37	207.50	12924603	506	51.80	13604173	204	1,829.00
12552173	21	199.00	12630073	91	64.90	12924604	506	51.80	13604174	204	1,829.00
12552174	21	199.00	12631073	93	79.90	12925003	506	37.90	13604183	204	1,829.00

Item no.	Page	Price in €	Item no.	Page	Price in €	Item no.	Page	Price in €	Item no.	Page	Price in €
13604184	204	1,829.00	13620164	206	549.90	13631174	206	739.90	13642184	207	1,049.00
13605163	204	359.90	13620173	206	549.90	13631183	206	739.90	13643163	207	1,229.00
13605164	204	359.90	13620174	206	549.90	13631184	206	739.90	13643164	207	1,229.00
13605173	204	359.90	13620183	206	549.90	13632163	206	899.90	13643173	207	1,229.00
13605174	204	359.90	13620184	206	549.90	13632164	206	899.90	13643174	207	1,229.00
13605183	204	359.90	13621163	206	639.90	13632173	206	899.90	13643183	207	1,229.00
13605184	204	359.90	13621164	206	639.90	13632174	206	899.90	13643184	207	1,229.00
13610163	204	609.90	13621173	206	639.90	13632183	206	899.90	13644163	207	1,579.00
13610164	204	609.90	13621174	206	639.90	13632184	206	899.90	13644164	207	1,579.00
13610173	204	609.90	13621183	206	639.90	13633163	206	1,049.90	13644173	207	1,579.00
13610174	204	609.90	13621184	206	639.90	13633164	206	1,049.90	13644174	207	1,579.00
13610183	204	609.90	13622163	206	799.90	13633173	206	1,049.90	13644183	207	1,579.00
13610184	204	609.90	13622164	206	799.90	13633174	206	1,049.90	13644184	207	1,579.00
13611163	204	729.90	13622173	206	799.90	13633183	206	1,049.90	13645163	207	549.90
13611164	204	729.90	13622174	206	799.90	13633184	206	1,049.90	13645164	207	549.90
13611173	204	729.90	13622183	206	799.90	13634163	206	1,380.00	13645173	207	549.90
13611174	204	729.90	13622184	206	799.90	13634164	206	1,380.00	13645174	207	549.90
13611183	204	729.90	13623163	206	949.90	13634173	206	1,380.00	13645183	207	549.90
13611184	204	729.90	13623164	206	949.90	13634174	206	1,380.00	13645184	207	549.90
13612163	204	1,219.00	13623173	206	949.90	13634183	206	1,380.00	13650163	207	769.90
13612164	204	1,219.00	13623174	206	949.90	13634184	206	1,380.00	13650164	207	769.90
13612173	204	1,219.00	13623183	206	949.90	13635163	206	509.90	13650173	207	769.90
13612174	204	1,219.00	13623184	206	949.90	13635164	206	509.90	13650174	207	769.90
13612183	204	1,219.00	13624163	206	1,180.00	13635173	206	509.90	13650183	207	769.90
13612184	204	1,219.00	13624164	206	1,180.00	13635174	206	509.90	13650184	207	769.90
13613163	204	1,489.00	13624173	206	1,180.00	13635183	206	509.90	13651163	207	879.90
13613164	204	1,489.00	13624174	206	1,180.00	13635184	206	509.90	13651164	207	879.90
13613173	204	1,489.00	13624183	206	1,180.00	13640163	207	669.90	13651173	207	879.90
13613174	204	1,489.00	13624184	206	1,180.00	13640164	207	669.90	13651174	207	879.90
13613183	204	1,489.00	13625163	206	409.90	13640173	207	669.90	13651183	207	879.90
13613184	204	1,489.00	13625164	206	409.90	13640174	207	669.90	13651184	207	879.90
13614163	204	2,009.00	13625173	206	409.90	13640183	207	669.90	13652163	207	1,249.00
13614164	204	2,009.00	13625174	206	409.90	13640184	207	669.90	13652164	207	1,249.00
13614173	204	2,009.00	13625183	206	409.90	13641163	207	779.90	13652173	207	1,249.00
13614174	204	2,009.00	13625184	206	409.90	13641164	207	779.90	13652174	207	1,249.00
13614183	204	2,009.00	13630163	206	649.90	13641173	207	779.90	13652183	207	1,249.00
13614184	204	2,009.00	13630164	206	649.90	13641174	207	779.90	13652184	207	1,249.00
13615163	204	439.90	13630173	206	649.90	13641183	207	779.90	13653163	207	1,429.00
13615164	204	439.90	13630174	206	649.90	13641184	207	779.90	13653164	207	1,429.00
13615173	204	439.90	13630183	206	649.90	13642163	207	1,049.00	13653173	207	1,429.00
13615174	204	439.90	13630184	206	649.90	13642164	207	1,049.00	13653174	207	1,429.00
13615183	204	439.90	13631163	206	739.90	13642173	207	1,049.00	13653183	207	1,429.00
13615184	204	439.90	13631164	206	739.90	13642174	207	1,049.00	13653184	207	1,429.00
13620163	206	549.90	13631173	206	739.90	13642183	207	1,049.00	13654163	207	1,979.00

Index

Item no.	Page	Price in €	Item no.	Page	Price in €	Item no.	Page	Price in €	Item no.	Page	Price in €
13654164	207	1,979.00	13665174	183	389.90	13680184	180	499.90	13692164	180	1,189.90
13654173	207	1,979.00	13665183	183	389.90	13681163	180	599.90	13692173	180	1,189.90
13654174	207	1,979.00	13665184	183	389.90	13681164	180	599.90	13692174	180	1,189.90
13654183	207	1,979.00	13670163	183	619.90	13681173	180	599.90	13692183	180	1,189.90
13654184	207	1,979.00	13670164	183	619.90	13681174	180	599.90	13692184	180	1,189.90
13655163	207	649.90	13670173	183	619.90	13681183	180	599.90	13693163	180	1,459.00
13655164	207	649.90	13670174	183	619.90	13681184	180	599.90	13693164	180	1,459.00
13655173	207	649.90	13670183	183	619.90	13682163	180	1,039.00	13693173	180	1,459.00
13655174	207	649.90	13670184	183	619.90	13682164	180	1,039.00	13693174	180	1,459.00
13655183	207	649.90	13671163	183	699.90	13682173	180	1,039.00	13693183	180	1,459.00
13655184	207	649.90	13671164	183	699.90	13682174	180	1,039.00	13693184	180	1,459.00
13660163	183	519.90	13671173	183	699.90	13682183	180	1,039.00	13694163	180	1,979.00
13660164	183	519.90	13671174	183	699.90	13682184	180	1,039.00	13694164	180	1,979.00
13660173	183	519.90	13671183	183	699.90	13683163	180	1,350.00	13694173	180	1,979.00
13660174	183	519.90	13671184	183	699.90	13683164	180	1,350.00	13694174	180	1,979.00
13660183	183	519.90	13672163	183	889.90	13683173	180	1,350.00	13694183	180	1,979.00
13660184	183	519.90	13672164	183	889.90	13683174	180	1,350.00	13694184	180	1,979.00
13661163	183	599.90	13672173	183	889.90	13683183	180	1,350.00	13695163	180	399.90
13661164	183	599.90	13672174	183	889.90	13683184	180	1,350.00	13695164	180	399.90
13661173	183	599.90	13672183	183	889.90	13684163	180	1,789.00	13695173	180	399.90
13661174	183	599.90	13672184	183	889.90	13684164	180	1,789.00	13695174	180	399.90
13661183	183	599.90	13673163	183	1,019.90	13684173	180	1,789.00	13695183	180	399.90
13661184	183	599.90	13673164	183	1,019.90	13684174	180	1,789.00	13695184	180	399.90
13662163	183	789.90	13673173	183	1,019.90	13684183	180	1,789.00	13700163	181	239.90
13662164	183	789.90	13673174	183	1,019.90	13684184	180	1,789.00	13700164	181	239.90
13662173	183	789.90	13673183	183	1,019.90	13685163	180	329.90	13700173	181	239.90
13662174	183	789.90	13673184	183	1,019.90	13685164	180	329.90	13700174	181	239.90
13662183	183	789.90	13674163	183	1,349.90	13685173	180	329.90	13700183	181	239.90
13662184	183	789.90	13674164	183	1,349.90	13685174	180	329.90	13700184	181	239.90
13663163	183	919.90	13674173	183	1,349.90	13685183	180	329.90	13710163	181	299.90
13663164	183	919.90	13674174	183	1,349.90	13685184	180	329.90	13710164	181	299.90
13663173	183	919.90	13674183	183	1,349.90	13690163	180	579.90	13710173	181	299.90
13663174	183	919.90	13674184	183	1,349.90	13690164	180	579.90	13710174	181	299.90
13663183	183	919.90	13675163	183	489.90	13690173	180	579.90	13710183	181	299.90
13663184	183	919.90	13675164	183	489.90	13690174	180	579.90	13710184	181	299.90
13664163	183	1,119.90	13675173	183	489.90	13690183	180	579.90	13720163	205	289.90
13664164	183	1,119.90	13675174	183	489.90	13690184	180	579.90	13720164	205	289.90
13664173	183	1,119.90	13675183	183	489.90	13691163	180	699.90	13720173	205	289.90
13664174	183	1,119.90	13675184	183	489.90	13691164	180	699.90	13720174	205	289.90
13664183	183	1,119.90	13680163	180	499.90	13691173	180	699.90	13720183	205	289.90
13664184	183	1,119.90	13680164	180	499.90	13691174	180	699.90	13720184	205	289.90
13665163	183	389.90	13680173	180	499.90	13691183	180	699.90	13730163	205	349.90
13665164	183	389.90	13680174	180	499.90	13691184	180	699.90	13730164	205	349.90
13665173	183	389.90	13680183	180	499.90	13692163	180	1,189.90	13730173	205	349.90

Item no.	Page	Price in €	Item no.	Page	Price in €	Item no.	Page	Price in €	Item no.	Page	Price in €
13730174	205	349.90	15205005	298	298.00	15291004	286	79.00	17240000	534	24.90
13730183	205	349.90	15205027	298	298.00	15291027	286	79.00	17241000	534	32.90
13730184	205	349.90	15206003	300	289.00	15292003	288	119.00	17242000	534	43.90
14011223	486	50.40	15206004	300	289.00	15292004	288	119.00	17243000	534	66.90
14035223	483	190.00	15206005	300	289.00	15292027	288	119.00	17244000	535	79.90
14036223	483	251.00	15206027	300	289.00	15311003	326	399.00	17502000	541	99.70
14037223	483	158.80	15209001	338	278.00	15311004	326	399.00	17511000	543 - 545	52.80
14050223	484	108.50	15215004	332	379.00	15311027	326	399.00	17518000	544	108.60
14051223	484	118.50	15216004	330	269.00	15312003	328	299.00	17528000	543	109.60
14052223	484	185.00	15221003	292	129.00	15314003	322	189.00	17613000	516	41.20
14053223	485	269.00	15221004	292	129.00	15314004	322	189.00	17613010	516	38.40
14054223	485	279.00	15221005	292	129.00	15314027	322	189.00	17613020	516	48.30
14114223	486	325.00	15221027	292	129.00	15317003	318	198.00	17621000	516	46.00
14116223	486	335.00	15222003	294	198.00	15317004	318	198.00	17621010	516	44.40
14660223	491	334.70	15222004	294	198.00	15317027	318	198.00	17621020	516	54.40
14661223	491	308.40	15222005	294	198.00	15362003	328	329.00	17640000	517	38.10
14662223	491	407.10	15222027	294	198.00	15717000	404	2.50	17640010	517	36.10
14664223	491	478.40	15223001	336	249.00	15718000	404	4.00	17640020	517	44.60
14670223	490	334.70	15223003	296	249.00	15719000	404	2.30	17643000	518	40.20
14671223	490	308.40	15223004	296	249.00	15720000	405	11.00	17643010	518	38.10
14672223	490	423.60	15223005	296	249.00	15721000	405	11.00	17643020	518	46.60
14673223	490	366.50	15223027	296	249.00	15725000	404	3.10	17648000	518	99.90
14678223	489	389.60	15225004	332	409.00	15726000	405	3.60	17648010	518	98.40
15201003	292	98.00	15226004	330	299.00	15728000	404	4.40	17648020	518	106.90
15201004	292	98.00	15271003	292	149.00	15729000	405	4.80	17652000	517	40.70
15201005	292	98.00	15271004	292	149.00	15731000	404	2.70	17652020	517	47.80
15201006	292	98.00	15271005	292	149.00	15732000	405	3.00	17657000	518	61.40
15201007	292	98.00	15271006	292	149.00	15891260	287 + 289	69.90	17657010	518	59.30
15201008	292	98.00	15271007	292	149.00	17106000	531	52.30	17658000	519	90.10
15201009	292	98.00	15271008	292	149.00	17107000	531	12.00	17658010	519	87.40
15201024	292	98.00	15271009	292	149.00	17108000	531	8.70	17658020	519	95.90
15201027	292	98.00	15271027	292	149.00	17110000	531	80.60	17662000	516	24.00
15202003	294	175.00	15272003	294	229.00	17121000	530	112.30	17662010	516	21.80
15202004	294	175.00	15272004	294	229.00	17122000	530	133.50	17662020	516	31.80
15202005	294	175.00	15272005	294	229.00	17206000	532	53.70	17663000	517	27.90
15202024	294	175.00	15272027	294	229.00	17207000	532	61.40	17663010	517	25.80
15202027	294	175.00	15273001	336	279.00	17214000	532	26.60	17663020	517	35.10
15203001	336	198.00	15273003	296	279.00	17223000	532	110.20	17664000	517	40.60
15203003	296	198.00	15273004	296	279.00	17224000	533	122.90	17664010	517	38.40
15203004	296	198.00	15273005	296	279.00	17225000	533	133.50	17664020	517	48.30
15203005	296	198.00	15273027	296	279.00	17226000	533	173.80	17666000	516	29.70
15203027	296	198.00	15275004	332	439.00	17230000	535	59.90	17671000	519	153.50
15205003	298	298.00	15279001	338	299.00	17231000	535	108.90	17671010	519	151.60
15205004	298	298.00	15291003	286	79.00	17232000	535	124.90	17671020	519	160.10

Index

Item no.	Page	Price in €	Item no.	Page	Price in €	Item no.	Page	Price in €	Item no.	Page	Price in €
17672000	519	189.50	17834010	528	76.30	1925.22	62	41.80	19681003	350	998.00
17672010	519	187.70	17836010	528	78.50	19300003	304	187.00	19681004	350	998.00
17672020	519	196.10	18101001	511	139.90	19300004	304	187.00	19681027	350	998.00
17683000	518	73.10	18151000	536	412.00	19300027	304	187.00	19681103	350	199.00
17683010	518	71.10	18152000	536	121.90	19300103	304	998.00	19681104	350	199.00
17683020	518	79.50	18153000	536	104.90	19300104	304	998.00	19681127	350	199.00
17684000	519	63.50	18154000	536	103.80	19300127	304	998.00	19682003	354	998.00
17684010	519	61.50	18155000	536	126.10	19301003	306	187.00	19682004	354	998.00
17684020	519	69.90	18156000	541	219.00	19301004	306	187.00	19682027	354	998.00
17723000	524	43.40	18157000	538	103.80	19301027	306	187.00	19682103	354	199.00
17723010	524	41.30	18161000	537	412.30	19301303	306	998.00	19682104	354	199.00
17723020	524	49.90	18162000	537	121.90	19301304	306	998.00	19682127	354	199.00
17746000	524	40.30	18164000	537	103.80	19301327	306	998.00	19683003	356	649.00
17746010	524	38.20	18165000	537	126.10	19302003	308	199.00	19683004	356	649.00
17746020	524	46.70	18190000	552	159.00	19302004	308	199.00	19683027	356	649.00
17748000	524	100.50	18192000	547	136.70	19302027	308	199.00	19683103	356	129.00
17748010	524	98.40	18194070	551	147.30	19302203	308	699.00	19683104	356	129.00
17748020	524	106.90	18194080	551	147.30	19302204	308	699.00	19683127	356	129.00
17758000	525	90.10	18195000	547	73.10	19302227	308	699.00	19684003	358	689.00
17758010	525	87.40	18196000	551	157.90	19303003	310	308.00	19684004	358	689.00
17758020	525	95.90	18197000	550	143.10	19303004	310	308.00	19684027	358	689.00
17767000	524	61.50	18198000	549	126.10	19303027	310	308.00	19684103	358	139.00
17767010	524	59.40	18199000	548	115.50	19303103	310	549.00	19684104	358	139.00
17767020	524	67.90	18200000	550	94.30	19303104	310	549.00	19684127	358	139.00
17771000	526	153.70	18201000	549	94.30	19303127	310	549.00	19685003	360	299.00
17771010	526	151.60	18202000	548	83.70	19304003	312	218.00	19685004	360	299.00
17771020	526	160.10	18205000	553	175.00	19304004	312	218.00	19685027	360	299.00
17772000	526	189.80	18207000	539	103.80	19304027	312	218.00	19686003	362	399.00
17772010	526	187.70	18220000	546	60.50	19304103	312	399.00	19686004	362	399.00
17772020	526	196.10	18223000	546	119.70	19304104	312	399.00	19686027	362	399.00
17777000	525	78.40	18233000	545	108.70	19304127	312	399.00	19691002	348	999.00
17777010	525	76.40	18438002	511	139.00	19305003	314	349.00	19692002	352	999.00
17783000	525	73.10	18503002	340	427.60	19305004	314	349.00	1996.02	63	24.50
17783010	525	71.10	18504002	342	275.00	19305027	314	349.00	1996.07	63	21.50
17783020	525	79.50	18506002	344	299.00	1963.02	56	22.00	1996.15	63	31.00
17788000	525	80.50	18523002	340	492.00	1963.03	56	28.00	1996.22	63	45.90
17788010	525	78.50	18524002	342	295.00	1963.05	56	25.00	20001070	53	47.50
17788020	525	87.00	18526002	344	329.00	1963.07	56	19.90	20001250	53	47.50
17822010	522	38.20	18573002	340	512.00	1963.15	56	28.00	2017.02	15	12.50
17823010	522	41.30	18574002	342	315.00	1964.02	57	25.50	2017.03	15	17.90
17824010	522	76.30	18576002	344	359.00	1964.03	57	29.90	2017.07	15	11.50
17826010	523	78.40	1925.02	62	22.20	1964.05	57	27.50	2030.02	151	9.50
17829010	522	98.30	1925.07	62	20.70	1964.07	57	23.90	2030.03	151	11.50
17833010	528	41.30	1925.15	62	28.60	1964.15	57	29.50	2030.05	151	10.50

Item no.	Page	Price in €	Item no.	Page	Price in €	Item no.	Page	Price in €	Item no.	Page	Price in €
2030.07	151	8.90	2358.00	159	12.00	36004220	128 + 452	69.00	36303030	59	34.80
2034.02	58	18.50	2358.02	159	11.40	36005070	130 + 454	71.40	36303070	59	26.30
2034.03	58	23.90	2358.07	159	9.10	36005220	130 + 454	71.40	36304020	60	26.80
2034.05	58	19.50	2358.15	159	12.00	36063070	48	42.50	36304070	60	22.80
2034.07	58	13.20	26004070	128 + 452	58.00	36063250	48	42.50	36304150	60	27.80
2034.08	58	15.60	26004220	128 + 452	58.00	36141020	56	33.00	36305020	61	27.60
20353070	50	23.40	26005070	130 + 454	60.40	36141030	56	39.00	36305070	61	23.90
20353150	50	25.60	26005220	130 + 454	60.40	36141050	56	36.00	36305150	61	28.60
20353680	50	23.40	3092.07	87	87.20	36141070	56	30.90	36306420	125 + 450	79.10
20355070	51	24.40	3093.02	86	80.30	36141150	56	39.00	36309250	44	36.50
20355150	51	27.40	3093.07	86	76.10	36142020	57	36.50	36310250	45	39.00
20355680	51	24.40	3093.15	86	87.30	36142030	57	41.90	36323250	52	54.80
20368070	123	35.70	3094.07	87	199.90	36142050	57	38.50	36357070	53	58.50
20368150	123	39.30	3096.02	86	67.70	36142070	57	34.90	36357250	53	58.50
20368680	123	35.70	3096.07	86	64.60	36142150	57	40.50	36453070	50	34.40
2062.02	124	32.50	3105	487	93.10	36143020	40	32.00	36453150	50	36.60
2062.07	124	29.30	3177	470	264.70	36143070	40	30.90	36453680	50	34.40
2062.25	124	31.10	32034073	171	98.00	36143080	40	30.90	36455070	51	35.40
2110.02	54	29.10	32035073	171	136.00	36143250	40	30.90	36455150	51	38.40
2110.07	54	27.40	32036073	171	184.00	36143630	40	35.50	36455680	51	35.40
2110.15	54	37.00	32040073	170	88.50	36143640	40	35.50	37005070	117 + 451	68.80
2111.02	55	30.50	32045073	144	112.00	36144020	42	34.50	37005420	117 + 451	71.40
2111.07	55	28.90	32045074	144	112.00	36144070	42	33.00	37006070	117 + 451	73.50
2111.15	55	38.60	32046073	144	95.00	36144080	42	33.00	37006420	117 + 451	77.40
2117.02	15	11.00	32046074	144	95.00	36144250	42	33.00	37015070	117 + 451	71.20
2117.03	15	13.40	32047073	144	155.00	36144630	42	38.00	37015420	117 + 451	73.30
2117.07	15	9.70	32047074	144	155.00	36144640	42	38.00	37016070	117 + 451	75.50
2169.02	59	21.20	32048073	144	138.00	36145020	62	33.20	37016420	117 + 451	79.40
2169.03	59	23.80	32048074	144	138.00	36145070	62	31.70	3702	219	9.70
2169.07	59	15.30	32049074	145	317.00	36145150	62	39.60	3714	416	9.90
2190.07	15	23.80	33353023	112	94.80	36145220	62	52.80	3715	416	9.90
2190.20	15	23.80	33353073	112	91.50	36147220	66 + 448	90.00	38063073	48	106.80
2190.22	15	21.40	33353083	112	91.50	36148220	67 + 449	95.30	38063253	48	106.80
2191.07	64	26.70	33353253	112	94.50	36149020	124	43.50	38141023	56	97.60
2191.20	64	26.70	33353643	112	100.10	36149070	124	40.30	38141033	56	103.30
2191.22	64	24.30	33355023	113	97.10	36149250	124	42.10	38141053	56	100.30
2264.22	122	32.50	33355073	113	93.80	36180020	58	29.50	38141073	56	95.20
2295.02	60	15.80	33355083	113	93.80	36180030	58	34.90	38141153	56	103.30
2295.07	60	11.80	33355253	113	96.90	36180050	58	30.50	38142023	57	100.80
2295.15	60	16.80	33355643	113	102.40	36180070	58	24.20	38142033	57	105.20
2296.02	61	16.60	35001420	470	229.00	36180080	58	26.60	38142053	57	102.80
2296.07	61	12.90	3506	530	54.00	36187250	46	33.00	38142073	57	99.20
2296.15	61	17.60	3559	416	76.40	36188250	47	38.00	38142153	57	104.80
2339.42	125 + 450	68.10	36004070	128 + 452	69.00	36303020	59	32.20	38143023	40	96.30

Index

Item no.	Page	Price in €	Item no.	Page	Price in €	Item no.	Page	Price in €	Item no.	Page	Price in €
38143073	40	95.20	38261253	25	77.50	38361643	25	82.80	38453683	50	98.70
38143083	40	95.20	38261633	25	82.80	38363023	68	44.50	38455073	51	99.70
38143253	40	95.20	38261643	25	82.80	38363073	68	41.30	38455153	51	102.70
38143633	40	99.80	38262023	27	77.50	38363153	68	44.50	38455683	51	99.70
38143643	40	99.80	38262073	27	76.50	38364023	27	77.50	38480153	132	66.90
38144023	42	98.90	38262083	27	76.50	38364073	27	76.50	38480173	132	59.90
38144073	42	97.30	38262253	27	80.70	38364083	27	76.50	38480183	132	59.90
38144083	42	97.30	38262633	27	86.00	38364253	27	80.70	38481153	133	67.90
38144253	42	97.30	38262643	27	86.00	38364633	27	86.00	38481173	133	60.90
38144633	42	102.30	38266073	126	96.60	38364643	27	86.00	38481183	133	60.90
38144643	42	102.30	38266083	126	96.60	38365023	70	46.50	38484153	134	69.90
38145023	62	97.50	38267073	127	102.60	38365073	70	42.40	38484173	134	62.90
38145073	62	96.00	38267083	127	102.60	38365153	70	46.50	38484183	134	62.90
38145153	62	103.90	38303023	59	96.50	38369073	65	44.50	38488153	135	70.90
38145223	62	117.10	38303033	59	99.10	38369223	65	47.60	38488173	135	63.90
38147223	66 + 448	154.30	38303073	59	90.60	3837	521	5.50	38488183	135	63.90
38148223	67 + 449	159.60	38304023	60	91.10	38370073	157	31.00	3900W	416	79.00
38149023	124	107.80	38304073	60	87.10	38370153	157	33.10	3900WW	416	79.00
38149073	124	104.60	38304153	60	92.10	38371033	153	58.20	3901W	416	79.00
38149253	124	106.40	38305023	61	91.90	38371073	153	56.10	3901WW	416	79.00
38180023	58	93.80	38305073	61	88.20	38371083	153	56.10	39063073	48	110.70
38180033	58	99.20	38305153	61	92.90	38371153	153	58.20	39063253	48	110.70
38180053	58	94.80	38306423	125 + 450	143.40	38371643	153	61.40	39116073	11	142.20
38180073	58	88.50	38309253	44	100.80	38375073	128 + 452	86.90	39141023	56	101.20
38180083	58	90.90	38310253	45	103.30	38375423	128 + 452	86.90	39141033	56	107.20
38182023	63	99.80	38323253	52	119.10	38376073	130 + 454	89.90	39141053	56	104.20
38182073	63	96.80	38326023	54	104.40	38376423	130 + 454	89.90	39141073	56	99.10
38182153	63	106.30	38326073	54	102.70	38377173	72	46.30	39141153	56	107.20
38182223	63	120.70	38326153	54	112.30	38377183	72	46.30	39142023	57	104.70
38187253	46	97.30	38327023	55	105.80	38378173	73	46.30	39142033	57	109.10
38188253	47	102.30	38327073	55	104.20	38378183	73	46.30	39142053	57	106.70
38201003	274	79.00	38327153	55	113.90	38379173	74	46.30	39142073	57	103.10
38201004	274	79.00	3835	521	3.80	38379183	74	46.30	39142153	57	108.70
38201027	274	79.00	38357073	53	122.80	3838	527	4.20	39143023	41	100.20
38202003	276	119.00	38357253	53	122.80	3839	527	4.80	39143073	41	99.10
38202004	276	119.00	3836	521	4.75	3840	527	5.80	39143083	41	99.10
38202027	276	119.00	38361023	25	74.30	38421023	49	76.20	39143253	41	99.10
38203003	278	179.00	38361073	25	73.30	38421024	49	76.20	39143633	41	103.70
38203004	278	179.00	38361074	25	73.30	38421073	49	66.40	39143643	41	103.70
38203027	278	179.00	38361083	25	73.30	38421074	49	66.40	39144023	43	102.70
38204002	280	179.00	38361084	25	73.30	38421253	49	72.90	39144073	43	101.20
38261023	25	74.30	38361253	25	77.50	38421254	49	72.90	39144083	43	101.20
38261073	25	73.30	38361254	25	77.50	38453073	50	98.70	39144253	43	101.20
38261083	25	73.30	38361633	25	82.80	38453153	50	100.90	39144633	43	106.20

Item no.	Page	Price in €	Item no.	Page	Price in €	Item no.	Page	Price in €	Item no.	Page	Price in €
39144643	43	106.20	39305073	61	92.10	39365153	70	48.60	39462073	28	95.30
39145023	62	101.40	39305153	61	96.80	39369073	65	49.30	39462253	28	99.80
39145073	62	99.90	39306423	125 + 450	147.30	39369223	65	52.60	39463023	68	55.00
39145153	62	107.80	39309253	44	104.70	39373023	77	74.60	39463073	68	51.80
39145223	62	121.00	39310253	45	107.20	39373073	77	71.30	39463153	68	55.00
39147223	66 + 448	158.20	39323253	52	123.00	39373153	77	74.60	39465023	70	57.10
39148223	67 + 449	163.50	39326023	54	108.30	39374023	77	76.80	39465073	70	52.80
39149023	124	111.70	39326073	54	106.60	39374073	77	74.60	39465153	70	57.10
39149073	124	108.50	39326153	54	116.20	39374153	77	76.80	39475073	129 + 453	92.10
39149253	124	110.30	39327023	55	109.70	39375073	129 + 453	87.70	39475423	129 + 453	92.10
39180023	58	97.70	39327073	55	108.10	39375423	129 + 453	87.70	39476073	131 + 455	95.10
39180033	58	103.10	39327153	55	117.80	39376073	131 + 455	90.70	39476423	131 + 455	95.10
39180053	58	98.70	39353023	112	98.70	39376423	131 + 455	90.70	39480153	132	69.00
39180073	58	92.40	39353073	112	95.40	39377173	72	48.40	39480173	132	62.00
39180083	58	94.80	39353083	112	95.40	39377183	72	48.40	39480183	132	62.00
39182023	63	103.70	39353253	112	98.40	39378173	73	48.40	39481153	133	70.00
39182073	63	100.70	39353643	112	104.00	39378183	73	48.40	39481173	133	63.00
39182153	63	110.20	39355023	113	101.00	39379173	74	48.40	39481183	133	63.00
39182223	63	125.10	39355073	113	97.70	39379183	74	48.40	39483023	76	78.00
39187253	46	101.20	39355083	113	97.70	39395073	30	141.60	39483073	76	76.90
39188253	47	106.20	39355253	113	100.80	39395074	30	141.60	39483083	76	76.90
39261023	25	78.20	39355643	113	106.30	39395083	30	141.60	39483253	76	76.90
39261073	25	77.20	39357073	53	126.70	39395084	30	141.60	39483633	76	81.60
39261083	25	77.20	39357253	53	126.70	39395253	30	150.30	39483643	76	81.60
39261253	25	81.40	39361023	25	78.20	39395254	30	150.30	39484153	134	72.00
39261633	25	86.70	39361073	25	77.20	39396073	31	144.90	39484173	134	65.00
39261643	25	86.70	39361074	25	77.20	39396074	31	144.90	39484183	134	65.00
39262023	27	81.40	39361083	25	77.20	39396083	31	144.90	39485023	76	80.50
39262073	27	80.40	39361084	25	77.20	39396084	31	144.90	39485073	76	79.40
39262083	27	80.40	39361253	25	81.40	39406073	11	177.90	39485083	76	79.40
39262253	27	84.60	39361254	25	81.40	39421023	49	80.10	39485253	76	79.40
39262633	27	89.90	39361633	25	86.70	39421024	49	80.10	39485633	76	84.10
39262643	27	89.90	39361643	25	86.70	39421073	49	70.30	39485643	76	84.10
39266073	126	100.50	39363023	68	46.50	39421074	49	70.30	39488153	135	73.00
39266083	126	100.50	39363073	68	43.40	39421253	49	76.80	39488173	135	66.00
39267073	127	106.50	39363153	68	46.50	39421254	49	76.80	39488183	135	66.00
39267083	127	106.50	39364023	27	81.40	39453073	50	102.60	40143023	41	110.70
39303023	59	100.40	39364073	27	80.40	39453153	50	104.80	40143073	41	109.60
39303033	59	103.00	39364083	27	80.40	39453683	50	102.60	40143083	41	109.60
39303073	59	94.50	39364253	27	84.60	39455073	51	103.60	40143253	41	109.60
39304023	60	95.00	39364633	27	89.90	39455153	51	106.60	40143633	41	114.20
39304073	60	91.00	39364643	27	89.90	39455683	51	103.60	40143643	41	114.20
39304153	60	96.00	39365023	70	48.60	39461073	28	92.00	40144023	43	113.20
39305023	61	95.80	39365073	70	44.50	39461253	28	96.50	40144073	43	111.70

Index

Item no.	Page	Price in €	Item no.	Page	Price in €	Item no.	Page	Price in €	Item no.	Page	Price in €
40144083	43	111.70	41444633	43	148.70	43003250	89	89.00	45009550	102	21.50
40144253	43	111.70	41444643	43	148.70	43003640	89	94.60	45009560	102	21.50
40144633	43	116.70	41463023	69	88.80	43004020	89	92.60	45010170	102	21.50
40144643	43	116.70	41463073	69	85.80	43004070	89	91.50	45010180	102	21.50
40363023	69	58.00	41463153	69	88.80	43004250	89	91.50	45010550	102	21.50
40363073	69	54.80	41465023	71	90.80	43004640	89	97.00	45010560	102	21.50
40363153	69	58.00	41465073	71	86.80	45000170	102	24.00	45011170	102	21.50
40365023	71	60.00	41465153	71	90.80	45000180	102	24.00	45011180	102	21.50
40365073	71	55.80	41475073	129 + 453	127.60	45000550	102	24.00	45011550	102	21.50
40365153	71	60.00	41475423	129 + 453	127.60	45000560	102	24.00	45011560	102	21.50
40369073	65	58.10	41476073	131 + 455	130.60	45001170	102	24.00	45020170	102	43.00
40369223	65	61.40	41476423	131 + 455	130.60	45001180	102	24.00	45020180	102	43.00
40375073	129 + 453	96.50	41477173	72	89.00	45001550	102	24.00	45020550	102	43.00
40375423	129 + 453	96.50	41477183	72	89.00	45001560	102	24.00	45020560	102	43.00
40376073	131 + 455	99.50	41478173	73	89.00	45002170	102	24.00	45021170	102	43.00
40376423	131 + 455	99.50	41478183	73	89.00	45002180	102	24.00	45021180	102	43.00
40377173	72	56.70	41479173	74	89.00	45002550	102	24.00	45021550	102	43.00
40377183	72	56.70	41479183	74	89.00	45002560	102	24.00	45021560	102	43.00
40378173	73	56.70	41480153	132	109.60	45003170	102	24.00	45022170	102	43.00
40378183	73	56.70	41480173	132	102.60	45003180	102	24.00	45022180	102	43.00
40379173	74	56.70	41480183	132	102.60	45003550	102	24.00	45022550	102	43.00
40379183	74	56.70	41481153	133	110.60	45003560	102	24.00	45022560	102	43.00
40480153	132	77.30	41481173	133	103.60	45004170	102	24.00	45023170	102	43.00
40480173	132	70.30	41481183	133	103.60	45004180	102	24.00	45023180	102	43.00
40480183	132	70.30	41484153	134	112.60	45004550	102	24.00	45023550	102	43.00
40481153	133	78.30	41484173	134	105.60	45004560	102	24.00	45023560	102	43.00
40481173	133	71.30	41484183	134	105.60	45005170	102	24.00	45024170	102	43.00
40481183	133	71.30	41488153	135	113.60	45005180	102	24.00	45024180	102	43.00
40484153	134	80.30	41488173	135	106.60	45005550	102	24.00	45024550	102	43.00
40484173	134	73.30	41488183	135	106.60	45005560	102	24.00	45024560	102	43.00
40484183	134	73.30	41542073	23	83.70	45006170	102	21.50	45025170	102	43.00
40488153	135	81.30	41542074	23	83.70	45006180	102	21.50	45025180	102	43.00
40488173	135	74.30	41543073	23	102.20	45006550	102	21.50	45025550	102	43.00
40488183	135	74.30	41543074	23	102.20	45006560	102	21.50	45025560	102	43.00
41443023	41	142.70	41544073	23	134.30	45007170	102	21.50	45026170	102	63.00
41443073	41	141.60	41544074	23	134.30	45007180	102	21.50	45026180	102	63.00
41443083	41	141.60	41552073	23	103.20	45007550	102	21.50	45026550	102	63.00
41443253	41	141.60	41552074	23	103.20	45007560	102	21.50	45026560	102	63.00
41443633	41	146.20	41553073	23	121.70	45008170	102	21.50	45027170	102	63.00
41443643	41	146.20	41553074	23	121.70	45008180	102	21.50	45027180	102	63.00
41444023	43	145.20	41554073	23	153.60	45008550	102	21.50	45027550	102	63.00
41444073	43	143.70	41554074	23	153.60	45008560	102	21.50	45027560	102	63.00
41444083	43	143.70	43003020	89	90.10	45009170	102	21.50	45028170	102	63.00
41444253	43	143.70	43003070	89	89.00	45009180	102	21.50	45028180	102	63.00

Item no.	Page	Price in €	Item no.	Page	Price in €	Item no.	Page	Price in €	Item no.	Page	Price in €
45028550	102	63.00	45107550	104	60.00	48211005	429	349.90	53057260	372	3.70
45028560	102	63.00	45107560	104	60.00	48221002	430	1,144.20	53058070	372	2.40
45029170	102	85.00	45108170	104	60.00	48222001	431	359.90	53058080	372	2.40
45029180	102	85.00	45108180	104	60.00	48224001	431	469.90	53058260	372	2.40
45029550	102	85.00	45108550	104	60.00	48290000	438	23.10	53059070	372	28.20
45029560	102	85.00	45108560	104	60.00	512811	52	43.80	53059080	372	28.20
45030170	102	85.00	45110170	104	60.00	53001000	366 - 388	3.40	53059260	372	28.20
45030180	102	85.00	45110180	104	60.00	53002000	379	10.90	53061070	379	20.50
45030550	102	85.00	45110550	104	60.00	53003000	369 - 390	4.30	53061260	379	19.80
45030560	102	85.00	45110560	104	60.00	53004000	369 - 390	3.40	53062260	387	2.90
45031170	102	85.00	45111170	104	60.00	53005000	366 - 388	3.50	53063070	373	4.10
45031180	102	85.00	45111180	104	60.00	53006000	373	39.50	53063080	373	4.10
45031550	102	85.00	45111550	104	60.00	53007000	372	9.80	53063260	373	4.10
45031560	102	85.00	45111560	104	60.00	53008000	379	5.20	53065070	380	21.60
45100170	104	66.00	45112170	104	60.00	53009000	387	10.50	53065080	380	21.60
45100180	104	66.00	45112180	104	60.00	53010000	382	5.50	53065260	380	20.90
45100550	104	66.00	45112550	104	60.00	53011000	382	17.90	53066070	382	4.40
45100560	104	66.00	45112560	104	60.00	53012000	382	15.90	53066080	382	4.40
45101170	104	66.00	45123170	104	112.00	53013000	382	13.40	53066260	382	4.40
45101180	104	66.00	45123180	104	112.00	53014000	389	3.80	53067260	368	19.30
45101550	104	66.00	45123550	104	112.00	53020000	394	4.30	53068260	386	52.00
45101560	104	66.00	45123560	104	112.00	53021000	394	11.40	53069070	382	28.00
45102170	104	66.00	45124170	104	112.00	53022260	394	65.80	53069080	382	28.00
45102180	104	66.00	45124180	104	112.00	53023000	397	4.10	53069260	382	25.50
45102550	104	66.00	45124550	104	112.00	53027080	374	2.30	53070070	388	2.90
45102560	104	66.00	45124560	104	112.00	53027260	374	2.30	53070260	388	2.90
45103170	104	66.00	45125170	104	112.00	53030000	367 - 398	14.90	53071070	388	20.70
45103180	104	66.00	45125180	104	112.00	53031000	398	7.20	53071260	388	20.10
45103550	104	66.00	45125550	104	112.00	53032000	386	57.90	53072260	389	4.00
45103560	104	66.00	45125560	104	112.00	53034000	367 - 391	6.20	53073070	390	3.00
45104170	104	66.00	45130170	176	46.20	53037260	284 + 392	1.60	53073080	390	3.00
45104180	104	66.00	45130180	176	46.20	53038260	282 + 375	1.70	53073260	390	3.00
45104550	104	66.00	45131170	176	52.00	53039260	283 + 376	2.50	53075260	398	33.40
45104560	104	66.00	45131180	176	52.00	53040000	282 - 392	2.20	53078070	394	3.10
45105170	104	66.00	45135170	176	76.40	53051070	366	21.10	53078260	394	3.10
45105180	104	66.00	45135180	176	76.40	53051260	366	19.90	53079070	397	4.00
45105550	104	66.00	45320070	119	45.90	53052260	368	2.70	53079260	397	4.00
45105560	104	66.00	45320080	119	45.90	53053260	368	2.70	53080070	397	4.00
45106170	104	60.00	45321070	119	48.10	53055070	369	21.80	53080260	397	4.00
45106180	104	60.00	45321080	119	48.10	53055080	369	21.80	53081070	397	52.70
45106550	104	60.00	48201084	433	569.90	53055260	369	21.10	53081260	397	41.60
45106560	104	60.00	48202082	433	744.20	53056070	372 - 390	4.40	53082070	397	26.10
45107170	104	60.00	48210004	429	879.90	53057070	372	3.70	53082260	397	25.30
45107180	104	60.00	48211003	429	349.90	53057080	372	3.70	53084070	390	25.40

Index

Item no.	Page	Price in €	Item no.	Page	Price in €	Item no.	Page	Price in €	Item no.	Page	Price in €
53084080	390	25.40	53402000	369 - 390	18.70	53651070	379	31.30	53901070	402	35.80
53084260	390	24.60	53402070	369 - 390	18.70	53651260	379	23.40	53901080	402	35.80
53085260	391	24.50	53402080	369 - 390	18.70	53652260	387	33.40	53901260	402	29.40
53086070	370	16.00	53404000	384 + 385	27.40	53653070	380	38.70	53902070	402	61.70
53086080	370	16.00	53404070	384 + 385	27.40	53653080	380	38.70	53902080	402	61.70
53087080	367	27.60	53431070	368 - 397	22.90	53653260	380	26.90	53902260	402	49.00
53087260	367	23.60	53432070	372 - 390	45.50	53654070	382	41.10	53911070	403	41.00
53088260	381	23.60	53440000	367 - 399	30.70	53654080	382	41.10	53911080	403	41.00
53089080	374	1.80	53440070	367 - 399	30.70	53654260	382	36.60	53911260	403	32.40
53089260	374	1.80	53440080	367 - 399	44.50	53655070	384	68.90	53912070	403	72.20
53090260	401	1.80	534700	561	1.20	53656070	385	77.40	53912080	403	72.20
53091070	384	4.10	534701	561	1.20	53657080	381	27.40	53912260	403	55.20
53092070	385	5.10	534702	561	1.20	53657260	381	26.20	53921070	403	42.30
53093260	398	36.00	534703	561	1.20	536600	554	4.20	53921080	403	42.30
53095260	401	11.50	534704	561	1.20	53680260	349 + 351	19.90	53921260	403	37.00
53110070	366	1.60	53489001	282 - 392	4.30	53681000	351 + 355	29.60	53922070	403	73.10
53110260	366	1.60	53489002	282 - 392	8.70	53681260	353 + 355	19.90	53922080	403	73.10
53114070	369	1.90	53489003	282 - 392	13.80	53682260	353 + 355	21.10	53922260	403	62.50
53114080	369	1.90	53489071	282 - 392	4.30	53683260	357	18.00	5397	54 + 55	9.20
53114260	369	1.90	53489072	282 - 392	8.70	53684260	359	15.80	58100020	413	459.90
53161070	379	1.60	53489073	282 - 392	13.80	53685000	351 + 355	62.50	58106020	410	319.90
53161260	379	1.60	53498	188	37.00	53685260	359	18.00	58107020	410	299.90
53164070	380	1.90	535500	555	5.30	53689000	351 + 355	26.40	58111020	234	369.90
53164080	380	1.90	535800	554	11.50	53690000	349 + 353	142.90	58112020	234	269.90
53164260	380	1.90	535900	554	11.50	53691000	349 + 351	13.80	58120150	413	599.90
532500	561	1.50	53600070	366	31.00	53700070	388	36.30	58126150	410	499.90
532600	561	5.30	53600260	366	24.90	53700260	388	28.10	58131150	235	419.90
53268000	349 + 351	18.60	53601260	368	23.70	53701260	389	22.10	58132150	235	449.90
53269000	353 + 355	18.60	53602070	369	36.90	53702070	390	49.30	58140080	413	499.90
532700	69 + 71	1.80	53602080	369	36.90	53702080	390	49.30	58146080	410	419.90
53270000	357	20.20	53602260	369	26.80	53702260	390	33.50	58151080	233	359.90
53271000	359	20.20	53603070	372	51.90	53703260	391	31.20	58152080	233	389.90
53380261	282 + 375	6.80	53603080	372	51.90	53751260	398	71.90	58153080	233	419.90
53380262	282 + 375	12.90	53603260	372	33.40	53753070	394	22.60	58154080	233	479.90
53380263	282 + 375	20.60	53604080	370	26.30	53753260	394	19.40	58160150	413	519.90
53381261	283 + 376	11.40	53604260	370	23.90	53754070	397	59.70	58166150	411	249.90
53381262	283 + 376	21.20	53605080	367	50.80	53754260	397	49.30	58167150	411	229.90
53381263	283 + 376	34.00	53605260	367	35.30	53755260	399	35.80	58171150	232	339.90
53385261	284 + 392	11.40	53607080	374	46.00	53756070	373 + 400	22.90	58172150	232	269.90
53385262	284 + 392	22.00	53607260	374	42.00	53756080	373 + 400	22.90	58173150	232	519.90
53385263	284 + 392	32.90	536100	555	13.30	53756260	373 + 400	17.20	58191000	185	369.90
53400000	366 - 401	15.40	536400	554	4.20	53760260	401	39.00	58192003	185	569.90
53400070	366 - 401	15.40	536500	555	8.40	5387	54 + 55	6.20	58193000	185	579.90
53401070	387	41.60	53650260	386	72.40	5388	54 + 55	9.90	58194003	185	819.90

Item no.	Page	Price in €	Item no.	Page	Price in €	Item no.	Page	Price in €	Item no.	Page	Price in €
58211000	186	279.90	58292003	230	329.90	60140180	477	132.50	73651260	379	1.60
58212003	186	469.90	58293000	175	179.90	60141180	462	103.90	73652260	387	2.30
58213000	187	349.90	58293000	230	179.90	60205183	469	197.40	73653070	380	2.70
58214003	187	589.90	58294003	175	369.90	60208183	469	175.50	73653080	380	2.70
58215744	187	479.90	58294003	230	369.90	60210183	468	146.20	73653260	380	1.90
58216737	187	779.90	58295000	175	249.90	60211183	468	196.00	73654070	382	2.90
58231787	188	250.10	58295000	230	249.90	60801643	503	269.90	73654080	382	2.90
58233000	189	289.90	58296003	175	499.90	60801644	503	269.90	73654260	382	2.90
58235000	189	329.90	58296003	230	499.90	60803643	503	459.90	73655070	384	4.40
58237000	189	419.90	58297000	175	389.90	60803644	503	459.90	73656070	385	5.00
58239000	189	529.90	58297000	230	389.90	60805643	503	559.90	73657080	381	1.90
58250000	190	229.90	58298003	175	689.90	60805644	503	559.90	73657260	381	1.90
58252000	191	269.90	58298003	230	689.90	73081070	397	3.40	73700070	388	2.60
58254000	191	301.10	58301003	244	849.00	73081260	397	2.80	73700260	388	2.00
58256000	191	389.10	58302003	245	1,079.00	73400000	366 - 401	1.10	73701260	389	1.50
58258000	191	489.90	58311003	244	644.00	73400070	366 - 401	1.10	73702070	390	3.30
58260150	208	279.90	58312003	245	749.00	73401070	387	2.80	73702080	390	3.30
58262150	208	301.10	58321003	244	822.00	73402000	369 - 390	1.30	73702260	390	2.30
58264150	208	469.90	58322003	244	959.00	73402070	369 - 390	1.30	73703260	391	2.20
58266150	208	539.90	58323003	245	999.00	73402080	369 - 390	1.30	73751260	398	4.80
58268150	209	649.90	60006103	499	218.00	73404000	384 + 385	1.90	73753070	394	1.60
58271000	174	89.90	60007103	499	278.00	73404070	384 + 385	1.90	73753260	394	1.40
58271000	230	89.90	60025183	475	159.90	73431070	368 - 397	1.50	73754070	397	4.10
58272003	174	279.90	60026183	475	159.90	73432070	372 - 390	3.00	73754260	397	3.30
58272003	230	279.90	60036103	499	295.80	73440000	367 - 399	2.10	73755260	399	2.50
58273000	174	119.90	60070180	498	242.80	73440070	367 - 399	2.10	73756070	400	1.60
58273000	230	119.90	60103223	492	189.90	73440080	367 - 399	3.10	73756080	400	1.60
58274003	174	319.90	60104183	492	259.90	73600070	366	2.10	73756260	400	1.30
58274003	230	319.90	60105643	492	148.30	73600260	366	1.70	73760260	401	2.50
58275000	174	179.90	60107183	464 + 471	175.50	73601260	368	1.60	73991000	366 - 401	5.80
58275000	230	179.90	60108183	464 + 471	184.30	73602070	369	2.60	73992000	366 - 401	5.30
58276003	174	439.90	60109643	492	104.90	73602080	369	2.60	75201003	292	2.80
58276003	230	439.90	60110103	474	240.40	73602260	369	1.90	75201004	292	2.80
58277000	174	249.90	60111103	495	210.50	73603070	372	3.50	75201005	292	2.80
58277000	230	249.90	60112103	495	359.00	73603080	372	3.50	75201006	292	2.80
58278003	174	579.90	60113183	493	209.90	73603260	372	2.30	75201007	292	2.80
58278003	230	579.90	60115103	461	198.00	73604080	370	1.70	75201008	292	2.80
58279000	174	389.90	60116103	461	328.00	73604260	370	1.60	75201009	292	2.80
58279000	230	389.90	60117183	493	179.00	73605080	367	3.20	75201024	292	2.80
58280003	174	699.90	60118183	493	210.50	73605260	367	2.50	75201027	292	2.80
58280003	230	699.90	60120103	498	289.00	73607080	374	2.90	75202003	294	2.60
58291000	175	139.90	60127173	476	136.80	73607260	374	2.70	75202004	294	2.60
58291000	230	139.90	60127183	476	136.80	73650260	386	4.90	75202005	294	2.60
58292003	175	329.90	60127253	476	143.10	73651070	379	2.20	75202024	294	2.60

Index

Item no.	Page	Price in €	Item no.	Page	Price in €	Item no.	Page	Price in €	Item no.	Page	Price in €
75202027	294	2.60	75271009	292	4.30	76303003	310	3.80	77024078	264	819.00
75203001	336	5.50	75271027	292	4.30	76303004	310	3.80	77024083	264	619.00
75203003	296	5.50	75272003	294	3.30	76303027	310	3.80	77024084	264	619.00
75203004	296	5.50	75272004	294	3.30	76304003	312	5.40	77024088	264	819.00
75203005	296	5.50	75272005	294	3.30	76304004	312	5.40	77024693	264	619.00
75203020	334	2.70	75272027	294	3.30	76304027	312	5.40	77024694	264	619.00
75203024	334	2.70	75273001	336	7.90	76305003	314	5.20	77024698	264	819.00
75203027	296	5.50	75273003	296	7.90	76305004	314	5.20	77033073	264	349.00
75203028	334	2.70	75273004	296	7.90	76305027	314	5.20	77033074	264	369.00
75203030	334	2.70	75273005	296	7.90	77003073	264	329.00	77033078	264	549.00
75203038	334	2.70	75273027	296	7.90	77003074	264	329.00	77033083	264	349.00
75203040	334	2.70	75275004	332	6.50	77003083	264	329.00	77033084	264	369.00
75205003	298	2.10	75279001	338	4.30	77003084	264	329.00	77033088	264	549.00
75205004	298	2.10	75311003	326	1.60	77003693	264	329.00	77033693	264	349.00
75205005	298	2.10	75311004	326	1.60	77003694	264	329.00	77033694	264	369.00
75205027	298	2.10	75311027	326	1.60	77004073	264	539.00	77033698	264	539.00
75206003	300	4.10	75312003	328	8.60	77004074	264	539.00	77034073	264	599.00
75206004	300	4.10	75314003	322	2.70	77004083	264	539.00	77034074	264	599.00
75206005	300	4.10	75314004	322	2.70	77004084	264	539.00	77034078	264	789.00
75206027	300	4.10	75314027	322	2.70	77004693	264	539.00	77034083	264	599.00
75209001	338	3.90	75317003	318	2.75	77004694	264	539.00	77034084	264	599.00
75215004	332	5.30	75317004	318	2.75	77013073	264	309.00	77034088	264	789.00
75216004	330	7.70	75317027	318	2.75	77013074	264	309.00	77034693	264	599.00
75221003	292	3.70	75362003	328	9.50	77013083	264	309.00	77034694	264	599.00
75221004	292	3.70	75503002	340	12.00	77013084	264	309.00	77034698	264	789.00
75221005	292	3.70	75504002	342	7.60	77013693	264	309.00	77113083	265	289.00
75221027	292	3.70	75506002	344	8.30	77013694	264	309.00	77113084	265	289.00
75222003	294	3.00	75523002	340	13.90	77014073	264	509.00	77113693	265	289.00
75222004	294	3.00	75524002	342	8.20	77014074	264	509.00	77113694	265	289.00
75222005	294	3.00	75526002	344	9.20	77014083	264	509.00	77114083	265	499.00
75222027	294	3.00	75573002	340	14.30	77014084	264	509.00	77114084	265	499.00
75223001	336	7.00	75574002	342	8.70	77014693	264	509.00	77114693	265	499.00
75223003	296	7.00	75576002	344	9.90	77014694	264	509.00	77114694	265	499.00
75223004	296	7.00	75998000	292 - 344	11.90	77023073	264	369.00	77123083	265	279.00
75223005	296	7.00	75999000	292 - 344	17.90	77023074	264	369.00	77123084	265	279.00
75223027	296	7.00	76300003	304	4.60	77023078	264	559.00	77123693	265	279.00
75225004	332	6.20	76300004	304	4.60	77023083	264	369.00	77123694	265	279.00
75226004	330	8.70	76300027	304	4.60	77023084	264	369.00	77124083	265	479.00
75271003	292	4.30	76301003	306	4.60	77023088	264	559.00	77124084	265	479.00
75271004	292	4.30	76301004	306	4.60	77023693	264	369.00	77124693	265	479.00
75271005	292	4.30	76301027	306	4.60	77023694	264	369.00	77124694	265	479.00
75271006	292	4.30	76302003	308	4.90	77023698	264	559.00	77133083	265	329.00
75271007	292	4.30	76302004	308	4.90	77024073	264	619.00	77133084	265	329.00
75271008	292	4.30	76302027	308	4.90	77024074	264	619.00	77133088	265	529.00

Item no.	Page	Price in €	Item no.	Page	Price in €	Item no.	Page	Price in €	Item no.	Page	Price in €
77133693	265	329.00	77234084	266	689.00	77334698	267	1,179.00	81007150	558	59.90
77133694	265	329.00	77234088	266	889.00	77353083	267	519.00	81008020	558	65.50
77133698	265	529.00	77234693	266	689.00	77353084	267	519.00	81008070	558	32.00
77134083	265	589.00	77234694	266	689.00	77353088	267	679.00	81008080	558	32.00
77134084	265	589.00	77234698	266	889.00	77353693	267	519.00	81008150	558	64.90
77134088	265	779.00	77243083	266	419.00	77353694	267	519.00	81009020	558	76.00
77134693	265	589.00	77243084	266	419.00	77353698	267	679.00	81009070	558	34.90
77134694	265	589.00	77243088	266	589.00	77354083	267	849.00	81009080	558	34.90
77134698	265	779.00	77243693	266	419.00	77354084	267	849.00	81009150	558	73.90
77143083	265	319.00	77243694	266	419.00	77354088	267	1,149.00	81011060	421	4.90
77143084	265	319.00	77243698	266	589.00	77354693	267	849.00	81011120	421	6.90
77143088	265	519.00	77244083	266	669.00	77354694	267	849.00	81011150	421	8.90
77143693	265	319.00	77244084	266	669.00	77354698	267	1,149.00	81014020	559	65.90
77143694	265	319.00	77244088	266	859.00	77401694	414	1,199.00	81014070	559	32.00
77143698	265	519.00	77244693	266	669.00	77402694	414	949.00	81014080	559	32.00
77144083	265	559.00	77244694	266	669.00	78011114	421	50.40	81014150	559	64.90
77144084	265	559.00	77244698	266	859.00	78012114	421	67.40	81015020	559	76.00
77144088	265	759.00	77313083	267	479.00	78013114	421	82.20	81015070	559	34.90
77144693	265	559.00	77313084	267	479.00	78014114	421	75.80	81015080	559	34.90
77144694	265	559.00	77313693	267	479.00	78015114	421	92.80	81015150	559	73.90
77144698	265	759.00	77313694	267	479.00	78310084	424	229.00	81016020	559	85.00
77213083	266	389.00	77314083	267	779.00	78311084	424	259.00	81016070	559	38.90
77213084	266	389.00	77314084	267	779.00	78312084	424	299.00	81016080	559	38.90
77213693	266	389.00	77314693	267	779.00	79030004	443	159.00	81016150	559	83.90
77213694	266	389.00	77314694	267	779.00	79031004	443	149.00	81017000	495	6.10
77214083	266	609.00	77323083	267	469.00	79130004	443	139.00	81018070	163	31.70
77214084	266	609.00	77323084	267	469.00	79230264	445	229.00	81019020	154	9.75
77214693	266	609.00	77323693	267	469.00	79231264	445	189.00	81019150	154	9.75
77214694	266	609.00	77323694	267	469.00	81001070	560	32.90	81020502	143 + 195	13.70
77223083	266	379.00	77324083	267	759.00	81004020	557	55.10	81020508	143 + 195	13.70
77223084	266	379.00	77324084	267	759.00	81004070	557	29.90	81020515	143 + 195	13.70
77223693	266	379.00	77324693	267	759.00	81004080	557	29.90	81020602	143 + 195	15.80
77223694	266	379.00	77324694	267	759.00	81004150	557	59.90	81020608	143 + 195	15.80
77224083	266	579.00	77333083	267	529.00	81005020	557	65.90	81020615	143 + 195	15.80
77224084	266	579.00	77333084	267	529.00	81005070	557	32.00	81020702	143 + 195	21.10
77224693	266	579.00	77333088	267	689.00	81005080	557	32.00	81020708	143 + 195	21.10
77224694	266	579.00	77333693	267	529.00	81005150	557	82.90	81020715	143 + 195	21.10
77233083	266	439.00	77333694	267	529.00	81006020	557	76.00	81020806	163	10.50
77233084	266	439.00	77333698	267	689.00	81006070	557	34.90	81020808	163	10.50
77233088	266	599.00	77334083	267	879.00	81006080	557	34.90	81020809	163	10.50
77233693	266	439.00	77334084	267	879.00	81006150	557	99.90	81020906	163	14.80
77233694	266	439.00	77334088	267	1,179.00	81007020	558	55.10	81020908	163	14.80
77233698	266	599.00	77334693	267	879.00	81007070	558	29.90	81020909	163	14.80
77234083	266	689.00	77334694	267	879.00	81007080	558	29.90	81021000	495	10.50

Index

Item no.	Page	Price in €	Item no.	Page	Price in €	Item no.	Page	Price in €	Item no.	Page	Price in €
81022000	495	61.50	81393170	250	26.40	88123070	255	16.70	88163080	254	145.10
81023000	495	23.50	81393171	250	24.30	88123080	255	16.70	88163250	254	145.10
81029020	155	13.65	81393180	250	26.40	88123680	255	16.70	88164070	254	194.80
81029150	155	13.65	81393181	250	24.30	88124070	255	33.60	88164080	254	194.80
81032040	144	49.90	81393182	250	15.10	88124080	255	33.60	88164250	254	194.80
81032042	144	16.50	81393680	250	26.40	88124680	255	33.60	88166070	255	19.30
81036070	144	121.80	81393681	250	24.30	88125070	255	7.50	88166080	255	19.30
81037070	145	127.10	81397170	251	29.60	88125080	255	7.50	88166680	255	19.30
81039020	156	16.30	81397171	251	26.40	88126070	255	37.10	88167070	255	19.30
81039150	156	16.30	81397180	251	29.60	88126080	255	37.10	88167080	255	19.30
81044080	424	25.00	81397181	251	26.40	88126680	255	37.10	88167680	255	19.30
81045250	424	27.00	81397182	251	17.20	88127070	255	37.10	88203020	334	275.00
81046250	424	31.00	81397680	251	29.60	88127080	255	37.10	88203024	334	275.00
81048000	424	65.00	81397681	251	26.40	88127680	255	37.10	88203028	334	275.00
81049080	424	27.00	82030170	90	13.10	88128070	255	57.00	88203030	334	275.00
81050000	424	16.90	82032170	90	23.10	88128080	255	57.00	88203038	334	275.00
81051000	424	9.00	82040170	90	13.10	88128680	255	57.00	88203040	334	275.00
81052000	424	18.00	82041170	90	24.20	88129070	255	57.00	88373173	252	189.00
81053000	424	27.00	82042170	90	25.60	88129080	255	57.00	88373174	252	189.00
81055000	424	45.00	82043170	90	44.00	88129680	255	57.00	88373175	252	189.00
81057000	424	9.90	83330000	529	6.90	88130070	255	73.10	88373183	252	189.00
81058000	424	11.00	83331000	529	10.50	88130080	255	73.10	88373184	252	189.00
81060000	424	9.90	88101070	254	37.10	88130680	255	73.10	88373185	252	189.00
81062000	424	9.90	88101080	254	37.10	88131070	255	45.20	88377173	253	229.00
81070000	462,478,498	42.80	88101250	254	37.10	88131080	255	45.20	88377174	253	229.00
81077000	173	10.50	88102070	254	70.80	88131680	255	45.20	88377175	253	229.00
81089000	145	30.00	88102080	254	70.80	88132070	255	2.30	88377183	253	229.00
81090000	424	9.90	88102250	254	70.80	88132080	255	2.30	88377184	253	229.00
81091170	10	14.40	88103070	254	102.70	88132680	255	2.30	88377185	253	229.00
81092000	424	9.90	88103080	254	102.70	88133070	255	10.40	88387173	249	199.00
81100640	503	99.90	88103250	254	102.70	88133080	255	10.40	88387174	249	199.00
81101640	503	99.90	88104070	254	136.40	88134070	255	57.10	88387175	249	199.00
81102640	503	99.90	88104080	254	136.40	88134080	255	57.10	88387183	249	199.00
81110640	503	34.00	88104250	254	136.40	88134680	255	57.10	88387184	249	199.00
81111640	503	52.00	88114070	255	11.50	88135000	255	21.80	88387185	249	199.00
81112640	503	69.00	88114080	255	11.50	88136000	255	30.10	88393173	250	139.00
81170030	445	37.60	88114680	255	11.50	88137000	255	38.30	88393174	250	139.00
81170050	445	41.00	88115070	255	7.50	88161070	254	54.00	88393175	250	139.00
81170100	445	44.40	88115080	255	7.50	88161080	254	54.00	88393183	250	139.00
81171000	445	61.50	88116250	255	9.30	88161250	254	54.00	88393184	250	139.00
81171001	445	61.50	88119250	255	7.80	88162070	254	97.50	88393185	250	139.00
81172050	443	54.70	88122070	255	16.70	88162080	254	97.50	88393683	250	139.00
81172100	443	61.50	88122080	255	16.70	88162250	254	97.50	88393684	250	139.00
81173000	443	82.00	88122680	255	16.70	88163070	254	145.10	88393685	250	139.00

Item no.	Page	Price in €	Item no.	Page	Price in €
88397173	251	149.00	9510W	428	189.90
88397174	251	149.00	9510WW	428	189.90
88397175	251	149.00	9513W	428	159.90
88397183	251	149.00	9513WW	428	159.90
88397184	251	149.00	9728.03	437	17.00
88397185	251	149.00	9728.05	437	18.30
88397683	251	149.00	9728.15	437	17.00
88397684	251	149.00	9730.03	437	20.40
88397685	251	149.00	9730.05	437	20.40
88673173	80	150.00	9730.15	437	20.40
88673174	80	150.00	9731.03	437	23.20
88673175	80	150.00	9731.05	437	23.20
88673183	80	150.00	9731.15	437	23.20
88673184	80	150.00	9733.03	438	31.00
88673185	80	150.00	9733.05	438	31.00
88677173	81	239.00	9733.15	438	31.00
88677174	81	239.00	973500	437	8.40
88677175	81	239.00	975100	436	2.00
88677183	81	239.00	975400	436	2.20
88677184	81	239.00	9760.02	436	10.60
88677185	81	239.00	9761.02	436	11.40
88681173	83	155.00	H1996.02	63	35.50
88681174	83	155.00	H1996.07	63	32.50
88681175	83	155.00	H1996.15	63	42.00
88681183	83	155.00	H1996.22	63	56.90
88681184	83	155.00	H2191.07	64	37.70
88681185	83	155.00	H2191.20	64	37.70
88687173	85	165.00	H2191.22	64	35.30
88687174	85	165.00	P3605WW	148	29.00
88687175	85	165.00	P3653WW	148	34.10
88687183	85	165.00	P3654WW	148	34.10
88687184	85	165.00	P3659WW	151	89.20
88687185	85	165.00	P3729WW	219	62.80
900000	434	256.50	P3730WW	219	75.90
90199	438	159.90	P3817WW	486	126.70
910000	434	1.50	P3930WW	217	125.90
910100	435	9.20	P3937WW	217	125.10
910200	434	7.20	R3928WW	215	114.80
910300	435	12.10	R3929WW	215	136.80
910400	434	15.50	R3940WW	216	122.00
910500	435	22.80	R3941WW	216	122.20
910800	435	50.70			
9419W	433	295.00			
9419WW	433	295.00			

Note: The items marked in red are subject to discount group 2.

General Terms and Conditions of Sale

1. General information - scope of application

1.1 Our Terms and Conditions of Sale shall apply exclusively; we shall not recognize any terms and conditions of the customer that conflict with or deviate from our Terms and Conditions of Sale unless we have expressly agreed to their validity in writing. Our Terms and Conditions of Sale shall also apply if we carry out the delivery to the customer without reservation in the knowledge that the customer's terms and conditions conflict with or deviate from our Terms and Conditions of Sale.

1.2 Our written offer and, if we issue an order confirmation, our written order confirmation shall be decisive for the content and scope of deliveries and services.

1.3 Our Terms and Conditions of Sale shall apply only to entrepreneurs within the meaning of § 310 (1) of the German Civil Code (BGB).

1.4 The following business conditions shall take precedence over any terms and conditions of the customer that deviate in content. The customer's waiver of the validity of any terms and conditions of his own shall also not be eliminated by our silence or our performance. Any deviation from the following terms and conditions requires our written confirmation in individual cases.

1.5 All technical data of our catalogs and other sales documents, lists and drawings as well as weight, dimension and mixture data have been carefully prepared; in case of errors, we reserve the right to make subsequent corrections.

1.6 It is the responsibility of the customer to check whether our product is suitable for the purpose specified by him/her.

1.7 As far as declarations according to these terms and conditions have to be made in writing, this is also complied with by the text form according to § 126 b of the BGB.

2. Offer - offer documents

2.1 If the order is to be qualified as an offer according to § 145 BGB, we may accept it within four weeks.

2.2 We reserve the property rights and copyrights to illustrations, drawings, calculations and documents; they may not be made accessible to third parties. This shall also apply to such written documents which are designated as "confidential". The customer must obtain our express written consent before passing them on to third parties. Offers shall only be valid in written form. The prices quoted are subject to the proviso that the order data on which the quotation was based remain unchanged.

2.3 We shall only produce initial samples and initial sample test reports upon express written agreement and against payment of a fee based on time and material.

2.4 For the products commissioned to us by the customer on the basis of drawings or samples, the customer shall be obligated to check for any third-party property rights and not to infringe them. If, in the event of non-compliance with this obligation, we are prohibited from manufacturing by a third party invoking an industrial property right belonging to it or if the product cannot be used due to the infringement of the industrial property right, we shall be entitled - without examining the legal situation and to the exclusion of all claims for damages on the part of the customer, irrespective of the legal grounds - to discontinue manufacture and delivery until the facts of the case have been clarified and to demand compensation from the customer, at least in the amount of 15% of the invoice value for the ordered product. The customer shall already now indemnify us against damages and other claims for compensation by third parties, in particular by holders of rights, upon first request. The scope of damages shall also include such costs as we incur in defending ourselves against third party claims.

3. Price - Payment terms

3.1 Unless otherwise stated in the order confirmation, our prices shall apply "ex works", including the packaging normally used by us for our products plus the value added tax applicable on the date of invoicing. Requested special packaging or repackaging or special small packaging will be charged to the customer. The prices apply in each case only to the contractually agreed quantity and design. If the customer requests changes that require more processing than is based on the contract or the usual production process, we reserve the right to make reasonable changes to the prices. We reserve the right, if after conclusion of the contract, our costs increase unforeseeably, in particular due to collective wage agreements, material price increases, in particular raw material price increases or energy cost increases, to adjust our prices by the amount of the cost increase thereby incurred.

3.2 The statutory value added tax is not included in our prices; it will be shown separately in the invoice at the statutory rate applicable on the day of invoicing.

3.3 The deduction of a cash discount shall require a special written agreement.

3.4 Unless otherwise stated in the order confirmation, the net purchase price (without deductions) shall be paid free of charge to the place of payment and shall be due for payment within 10 days of the invoice date. If the customer is in default of payment, we shall be entitled to claim default interest in the amount of 9 percentage points above the statutory base interest rate per annum. If we are able to prove higher damages caused by default, we shall be entitled to claim such damages. However, the customer shall be entitled to prove to us that we have incurred no or less damage as a result of the default in payment.

3.5 The customer shall only be entitled to set-off rights if his counterclaims have been legally established, are undisputed or acknowledged by us, or if they are in a reciprocal relationship (synallagmatic contractual relation) to the main claim. The customer shall only be entitled to a right of retention due to counterclaims which have been established, are undisputed, recognized by us or are in a reciprocal relationship (synallagma) to the main claim. In addition, the customer shall be entitled to exercise a right of retention insofar as the customer's counterclaim is based on the same contractual relationship.

3.6 Credit notes shall be issued expressly for the purpose of set-off. A claim for payment does not exist.

3.7 If there are doubts about the solvency of the customer, we reserve the right to demand advance payments or securities. If it becomes known to us that the customer has been seized without success or if we receive indications of the customer's financial collapse, we shall be entitled to withdraw from the contract, setting off the expenses incurred.

4. Delivery time - delivery conditions

4.1 The start of the delivery period stated by us or agreed with us shall be subject to the clarification of all technical questions, documents to be provided by the customer, necessary permits and releases, especially of plans, as well as the compliance with the agreed terms of payment and the fulfillment of other cooperative acts by the customer.

4.2 Compliance with our delivery obligation further presupposes the timely and proper fulfillment of the customer's obligation as well as our proper supply with the raw materials required for the manufacture of the delivery product. The defense of non-performance of the contract remains reserved.

4.3 If non-compliance with delivery deadlines is due to force majeure, e.g. strike, pandemic, lockout, etc., the deadlines shall be extended accordingly. Such a reasonable extension of the delivery periods shall also occur if we are not supplied correctly and on time (reservation of correct and timely self-supply).

4.4 If the customer is in default of acceptance or culpably violates other obligations to cooperate, we shall

be entitled to demand compensation for the damage incurred by us in this respect, including any additional expenses. Further claims or rights remain reserved. If the delivery, shipment or provision is postponed at the request of the customer, we may charge the customer a storage fee of 0.05% of the invoice amount for each month or part thereof, but not more than 5% of the invoice amount, 10 days after we have notified the customer that the goods are ready for shipment. Both contracting parties reserve the right to prove higher or lower expenses.

4.5 Insofar as the prerequisites in section 4.4 exist, the risk of accidental loss or accidental deterioration of the object of sale shall pass to the customer at the point in time at which the customer has fallen into acceptance or debtor's default.

4.6 We shall be liable in accordance with the statutory provisions insofar as the underlying purchase contract is a transaction for delivery by a fixed date within the meaning of § 286 (2) No. 4 of the BGB or § 376 of the German Commercial Code (HGB). We shall also be liable in accordance with the statutory provisions if, as a consequence of a delay in delivery for which we are responsible, the customer justifiably asserts that it is not interested in continuing the contract.

4.7 We shall also be liable in accordance with the statutory provisions insofar as the delay in delivery is due to an intentional or grossly negligent breach of contract for which we are responsible; fault on the part of our representatives or vicarious agents shall be attributed to us. In the event of force majeure in accordance with Section 4.3, our representatives or vicarious agents shall not be deemed to be at fault. If the delay in delivery is due to a grossly negligent breach of contract for which we are responsible, our liability for damages shall be limited to the foreseeable, typically occurring damage.

4.8 We shall also be liable in accordance with the statutory provisions if the delay in delivery for which we are responsible is due to a culpable breach of a material contractual obligation; in this case, however, our liability for damages shall be limited to the foreseeable, typically occurring damage.

4.9 We shall be entitled to make partial deliveries to a reasonable extent. Deviations with regard to the dimensions, weight, technical design, manufacture and scope of the goods to be delivered are permissible within the customary product-specific tolerances. In addition, changes which serve the technical improvement of our products shall be deemed to have been approved by the customer.

5. Transfer of risk - packaging costs

5.1 Unless otherwise stated in the order confirmation, delivery "ex works" is deemed agreed.

5.2 Separate agreements shall apply to the return of packaging.

5.3 If the customer so desires, we shall cover the delivery by transport insurance; the costs incurred in this respect shall be borne by the customer.

5.4 Within a reasonable period of time prior to delivery of the goods, the customer shall be obligated to name one or more persons who are authorized to accept the goods and the accompanying documents and to sign the delivery documents and accompanying documents by the customer. This shall apply in particular if the goods are to be delivered to a place other than the customer's registered office. If such information is not provided, those persons who have actually taken delivery of the goods shall be deemed to be authorized to take delivery of the goods and to sign the transfer documents (delivery bill and other accompanying documents).

5.5 If no person designated by the customer is present at the specified place on the agreed date or if this person or other persons are not prepared to accept the goods, the customer shall be in default of acceptance with the consequence that the risk shall pass to the customer. Furthermore, the customer shall bear

the additional costs arising from the fact that a new delivery is made.

5.6 The customer may not refuse to accept deliveries on account of insignificant defects.

6. Liability for defects

6.1 Claims for defects on the part of the customer shall be subject to the condition that the customer has duly complied with its obligations to inspect the goods and to give notice of defects pursuant to § 377 of the German Commercial Code (HGB).

6.2 Insofar as the purchased item is defective, we shall be entitled, at our discretion, to subsequent performance in the form of rectification of the defect or delivery of a new item free of defects. In the event of rectification of defects, we shall be obliged to bear all expenses necessary for the purpose of subsequent performance, in particular transport, travel, labor and material costs as well as the expenses for removing the defective item and installing or mounting the rectified or delivered non-defective item, unless these are increased by the fact that the purchased item was transported to a place other than the place of performance, unless the transport corresponds to its intended use. We may refuse subsequent performance if the expenses for remedying the defect are likely to exceed the purchase price.

6.3 We shall bear the installation and removal costs only if the item has been installed in another item or attached to another item in accordance with its type and intended use and we are responsible for the defect which is the cause for the assertion of the claim for subsequent performance.

6.4 If the subsequent performance fails, the customer shall be entitled, at his/her discretion, to demand withdrawal from the contract or a reduction in the purchase price.

6.5 We shall be liable in accordance with the statutory provisions if the customer asserts claims for damages based on intent or gross negligence, including intent or gross negligence on the part of our representatives or vicarious agents. Insofar as we are not accused of intentional breach of contract, the liability for damages shall be limited to the foreseeable, typically occurring damage.

6.6 We shall be liable in accordance with the statutory provisions insofar as we culpably breach a material contractual obligation; in this case, too, however, liability for damages shall be limited to the foreseeable, typically occurring damage. A material contractual obligation exists if the breach of duty relates to an obligation that the customer has relied on and was entitled to rely on.

6.7 Liability for culpable injury to life, limb or health shall remain unaffected; this shall also apply to mandatory liability under the Product Liability Act.

6.8 Unless otherwise stipulated above, liability is excluded.

6.9 The limitation period for claims for defects shall be 12 months, calculated from the transfer of risk.

7. Total liability

7.1 Any further liability for damages than provided for in clause 6 and clause 4 shall be excluded - irrespective of the legal nature of the asserted claim. This applies in particular to claims for damages arising from faults at the conclusion of a contract, from other breaches of duty or from tortious claims for compensation for property damage pursuant to § 823 BGB.

7.2 An exclusion period of 18 months shall apply to the limitation of all claims which are not subject to the limitation period due to a defect in the item. It shall commence as of knowledge of the damage and the person causing the damage.

7.3 The limitation according to clause 7.1 shall also apply insofar as the customer demands compensation for useless expenses instead of a claim for damages in lieu of performance.

7.4 Insofar as our liability for damages is excluded or limited, this shall also apply with regard to the personal liability for damages of our employees, representatives and vicarious agents.

8. Retention of title

8.1 We retain title to the purchased goods until receipt of all payments arising from the business relationship with the customer. If the customer breaches his/her contractual obligations or defaults on payment, we may withdraw from the contract if he/she fails to comply with his/her obligations after setting a reasonable deadline or if we cannot reasonably be expected to adhere to the contract even without a reminder. We can also declare the withdrawal by taking back the object of sale. After taking back the object of sale, we shall be entitled to use it at our discretion; the proceeds from such usage shall be credited against the customer's liabilities - less reasonable usage costs.

8.2 Until the final transfer of title, the customer shall be obliged to treat the object of sale with care; in particular, the customer shall be obliged to insure it adequately at its own expense against damage by fire, water and theft at its replacement value. If maintenance and inspection work is required, the customer must carry this out in good time at his/her expense.

8.3 In the event of seizures or other interventions by third parties, the customer shall notify us in writing without delay so that we can bring an action in accordance with § 771 of the German Code of Civil Procedure (ZPO). Insofar as the third party is not in a position to reimburse us for the court and out-of-court costs of a lawsuit in accordance with § 771 of the ZPO, the customer shall be liable for the loss incurred by us.

8.4 The customer shall be entitled to resell the purchased goods in the ordinary course of business; however, he/she hereby assigns to us all claims in the amount of the final invoice amount (including VAT) of our claim accruing to him/her from the resale against his/her customers or third parties, irrespective of whether the purchased goods have been resold without or after processing. The customer shall remain authorized to collect this claim even after the assignment. Our authority to collect the claim ourselves shall remain unaffected by this. However, we undertake not to collect the claim as long as the customer meets its payment obligations from the proceeds received, is not in default of payment and, in particular, has not filed for insolvency proceedings or suspended payments. If this is the case, however, we may demand that the customer inform us of the assigned claims and their debtors, provide all information required for collection, hand over the relevant documents and inform the debtors (third parties) of the assignment. The claim assigned by us in advance also relates to the recognized balance, as in the case of insolvency of the customer to the then existing causal balance.

8.5 The processing or transformation of the object of sale by the customer shall always be carried out for us. If the object of sale is processed with other objects not belonging to us, we shall acquire co-ownership of the new object in the ratio of the value of the object of sale (final invoice amount, including VAT) to the other processed objects at the time of processing. In all other respects, the same shall apply to the item created by processing as to the purchased item delivered under reservation of title.

8.6 If the object of sale is inseparably mixed with other objects not belonging to us, we shall acquire co-ownership of the new object in the ratio of the value of the object of sale (final invoice amount, including value added tax) to the other mixed objects at the time of mixing. If the mixing takes place in such a way that the customer's item is to be regarded as the main item, it shall be deemed to be agreed that the customer transfers co-ownership to us on a pro rata basis. The customer shall hold the sole ownership or co-ownership thus created in safe custody for us.

8.7 The customer also assigns to us the claims to secure our claims against him which arise against a third party as a result of the connection of the object of sale with a plot of land.

8.8 We undertake to release the securities to which we are entitled at the customer's request to the extent that the realizable value of our securities exceeds the claims to be secured by more than 10%; the selection of the securities to be released shall be incumbent on us.

9. Place of jurisdiction - place of power - severability clause

9.1 If the customer is a merchant, the place of jurisdiction for all disputes arising shall be Sundern (Sauerland), to the exclusion of other places of jurisdiction; however, we shall also be entitled to sue the customer at his/her general place of jurisdiction.

9.2 The law of the Federal Republic of Germany shall apply; the UN Convention on Contracts for the International Sale of Goods shall not apply.

9.3 Unless otherwise stated in the order confirmation, the place of power for all services and counter-services, including payments, shall be our headquarters in Sundern (Sauerland).

9.4 These General Terms and Conditions of Sale shall remain valid even if individual clauses prove to be invalid. The invalid clause shall be supplemented or reinterpreted by the parties in such a way that the economic purpose intended by the invalid provision is achieved as far as possible. The same procedure shall be followed if a gap requiring supplementation arises during the power of the contractual relationship. If the invalidity is based on a power or time provision, it shall be replaced by the legally permissible provision. If any provision of these General Terms and Conditions of Sale is or becomes invalid with regard to mandatory foreign law, the customer shall, upon request, agree with us such contractual supplements and make such declarations to third parties or authorities as will ensure the validity of the provision concerned and, if this is not possible, its economic content also under the foreign law.

9.5 The German version of the General Terms and Conditions of Sale shall be the authoritative version. It shall take precedence over the English translation in the case of translations and shall be structured in accordance with German case law.

Status: June 2021

Single-housing attachment.

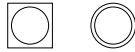

Switchable constant current converter + LED module

Power	Converter	Number of converters	LED module	Number of LED modules
3 W	17666000	1 x	12925..., 12926...	1 x
	17662000	1 x	12925..., 12926...	1 x
6 W	17662000	1 x	12923..., 12924..., 12920...	1 x

Constant current converter phase section + LED module

Power	Converter	Number of converters	LED module	Number of LED modules
6 W	17652000	1 x	12923..., 12924..., 12920...	1 x
6 W d2w	17652000	1 x	12963...	1 x

Constant current converter DALI + LED module

Power	Converter	Number of converters	LED module	Number of LED modules
3 W	17658000	1 x	12925..., 12926...	1 x
6 W	17658000	1 x	12923..., 12924..., 12920...	1 x
6 W d2w	17658000	1 x	12963...	1 x

Constant current converter white light / TunableWhite + LED module

Power	NG + controller	LED module	Number of LED modules
8 W	Outside *	12823003 (2850 K)	1 x
8 W	Outside *	12843004 (TunableWhite)	1 x

Constant current converter RGBW + LED module

Power	NG + controller	LED module	Number of LED modules
8 W	Outside *	18438002 (RGBW)	1 x

* The power supply and the controller must be provided outside the housing on the site.

Double-housing attachment.



Switchable constant current converter + LED module

Power	Converter	Number of converters	LED module	Number of LED modules
2 x 3 W	17662000	1 x	12925..., 12926...	2 x
	17613000	1 x	12925..., 12926...	2 x
2 x 6 W	17613000	1 x	12923..., 12924..., 12920...	2 x
	17621000	1 x	12923..., 12924..., 12920...	2 x

Constant current converter phase section + LED module

Power	Converter	Number of converters	LED module	Number of LED modules
2 x 3 W	17663000	1 x	12925..., 12926...	2 x
	17652000	1 x	12925..., 12926...	2 x
2 x 6 W	17664000	1 x	12923..., 12924..., 12920...	2 x
	17643000	1 x	12923..., 12924..., 12920...	2 x
2 x 6 W d2w	17664000	1 x	12963...	2 x
	17643000	1 x	12963...	2 x

Constant current converter DALI + LED module

Power	Converter	Number of converters	LED module	Number of LED modules
2 x 3 W	17683000*	1 x	12925..., 12926...	2 x
2 x 6 W	17683000*	1 x	12923..., 12924..., 12920...	2 x
2 x 6 W d2w	17683000*	1 x	12963...	2 x

* Naturally, equipment with 2 x 17658000 is also possible here.

Constant current converter 1-10 V + LED module

Power	Converter	Number of converters	LED module	Number of LED modules
2 x 3 W	17657000	1 x	12925..., 12926...	2 x
2 x 6 W	17657000	1 x	12923..., 12924..., 12920...	2 x
2 x 6 W d2w	17657000	1 x	12963...	2 x

Constant current converter white light / TunableWhite + LED module

Power	NG + controller	LED module	Number of LED modules
2 x 8 W	Outside *	12823003 (2850 K)	2 x
2 x 8 W	Outside *	12843004 (TunableWhite)	2 x

Constant current converter RGBW + LED module

Power	NG + controller	LED module	Number of LED modules
2 x 8 W	Outside *	18438002 (RGBW)	2 x

* The power supply and the controller must be provided outside the housing on the site.

Color coding



02 = chromium



17 = structural white



56 = black/white



03 = chromium matte



18 = structural black



62 = aluminum glossy brushed



05 = gold



20 = clear stainless steel powder-coated



63 = champagne matte



07 = white
27 = white powder-coated stainless steel



22 = stainless steel
42 = stainless steel V4A



64 = titanium matte



08 = black



25 = aluminum matte



68 = silver
69 = structural silver



10 = structural graphite



40 = white/chromium



73 = concrete



15 = nickel matte



55 = black/white



75 = white/gold





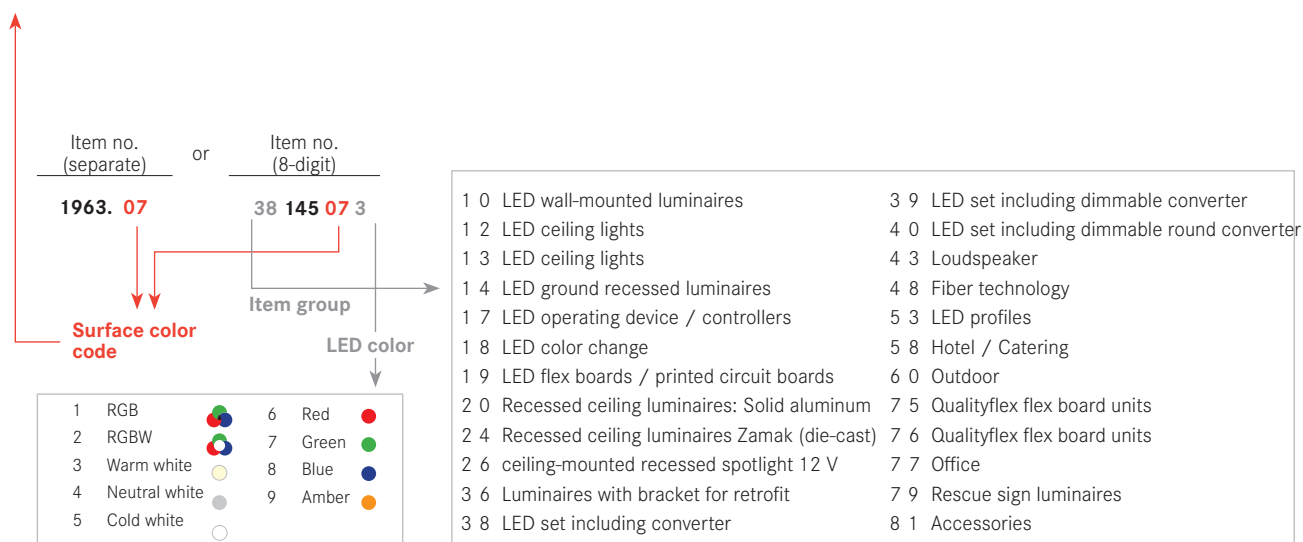









































85 = black/gold



* Special product.

Caution! The product with the red, green, blue or amber light color is a special product. This product with these light colors is used for colorful illumination. The spectral distribution of the light is used to change the appearance of illuminated scenes or illuminated objects in addition to making them visible. The product is not intended for use in other applications. The special product is not suitable for room lighting in households.

	Connected in parallel (constant voltage)		Luminaires for installation in furniture made of materials with unknown fire behavior		IP... Protection class, for explanation see below
	Connection is made as a series connection (constant current)		Not suitable for installation in device/mounting boxes		V4A The item is partly made of V4A stainless steel and appropriate for use near the coast.
	Luminaire operating current corresponds to the specified mA value (constant current)		Rotation angle of different directions in °		Moisture impregnated membrane
	Luminaire operating voltage 12 V direct current (DC)		Cardanic rotation angle in °		VDE certification
	Luminaire operating voltage 24 V direct voltage (DC)		Swivel angle in °		ENEC - Certification
	Luminaire operating voltage 230 V alternating voltage (AC)		IK... Protection against mechanical shock / mechanical stress		Load capacity in kg
	Lights installation depth in mm The specified installation depth is the mechanical installation depth (pure luminaire dimension)! Please refer to the installation instructions for the actual installation depth.		Illuminant mounting WITHOUT visible circlip		The item should not be covered with thermal insulation material
	Round ceiling (Ø) or square ceiling cut-out in mm		Specification of the usable bracket for the item. Caution: LV luminaires are generally supplied WITHOUT bracket. Please order if required!		Not suitable for use with cold-light mirror lamps larger than 35 W
	Dimmable via phase control and/or sectional dimmer		The item is equipped with our Plug&Play connector systems for easy wiring. Incorrect wiring is no longer possible.		Maximum luminous flux in lumen. The exact values are available on request. Measurement according to DIN EN 13032: this standard regulates, among other things, methods of measurement (e.g. by goniophotometer) and the presentation of photometric data (light distribution curve) for lights and lamps.
	Protection class I: with protective earth (PE)		Dimmable via 1-10 V interface		You can operate this item using Bluetooth.
	Protection class II: with protective insulation (e.g. plastic housing or reinforced or double insulation)		Dimmable via DALI-BUS		You can download the light distribution curves for these items from www.brumberg.com.
	Protection class III: Protective extra-low voltage: Voltages <= 50 V AC; <= 120 V DC		Dimmable via DALI-BUS 2		Short pitch: Distance from LED chip center to LED chip center (LED flex boards)
	Maximum length, one roll (LED flex boards)		Luminares are also compatible with all other MR16 from page 506 onwards.		Solder the connection cable (LED flex boards)
	Ambient temperature (LED flex boards)		Number of LEDs per meter (LED flex boards)		Dimmable (LED flex boards)
	Nominal operating duration at BLF 100% (rescue sign luminaires)		Nominal operating duration at BLF 40% Rescue sign luminaires		Detection distance in m Rescue sign luminaires

Protection classes

The **protection class** of a luminaires indicates the protection against penetration of foreign bodies and moisture. The designation follows the following schema: IP XX
The letters IP stand for protection class and the placeholders are replaced as follows. 1. Digit: Foreign body protection, 2. Digit: Water protection

Code numbers for contact protection / foreign body protection

IP 0X	Unprotected
IP 1X	Protected against solid foreign bodies larger than > 50 mm.
IP 2X	Protected against solid foreign bodies larger than > 12 mm.
IP 3X	Protected against solid foreign bodies larger than > 2.5 mm.
IP 4X	Protected against solid foreign bodies larger than > 1 mm.
IP 5X	Dustproof
IP 6X	Dustproof

Codes for water protection

IP X0	Not protected against water penetration
IP X1	Protected against vertically falling dripping water
IP X2	Protected against dripping water falling at an angle (15° from vertical)
IP X3	Protected against water spray (up to 60° from vertical)
IP X4	Protected against water spray
IP X5	Protected against water jets
IP X6	Protected against water penetration during temporary flooding
IP X7	Protected against water penetration during immersion
IP X8	Protected against water penetration during for an indefinite period of time

Example: IP 44 means protected against solid foreign bodies > 1 mm and against water spray.

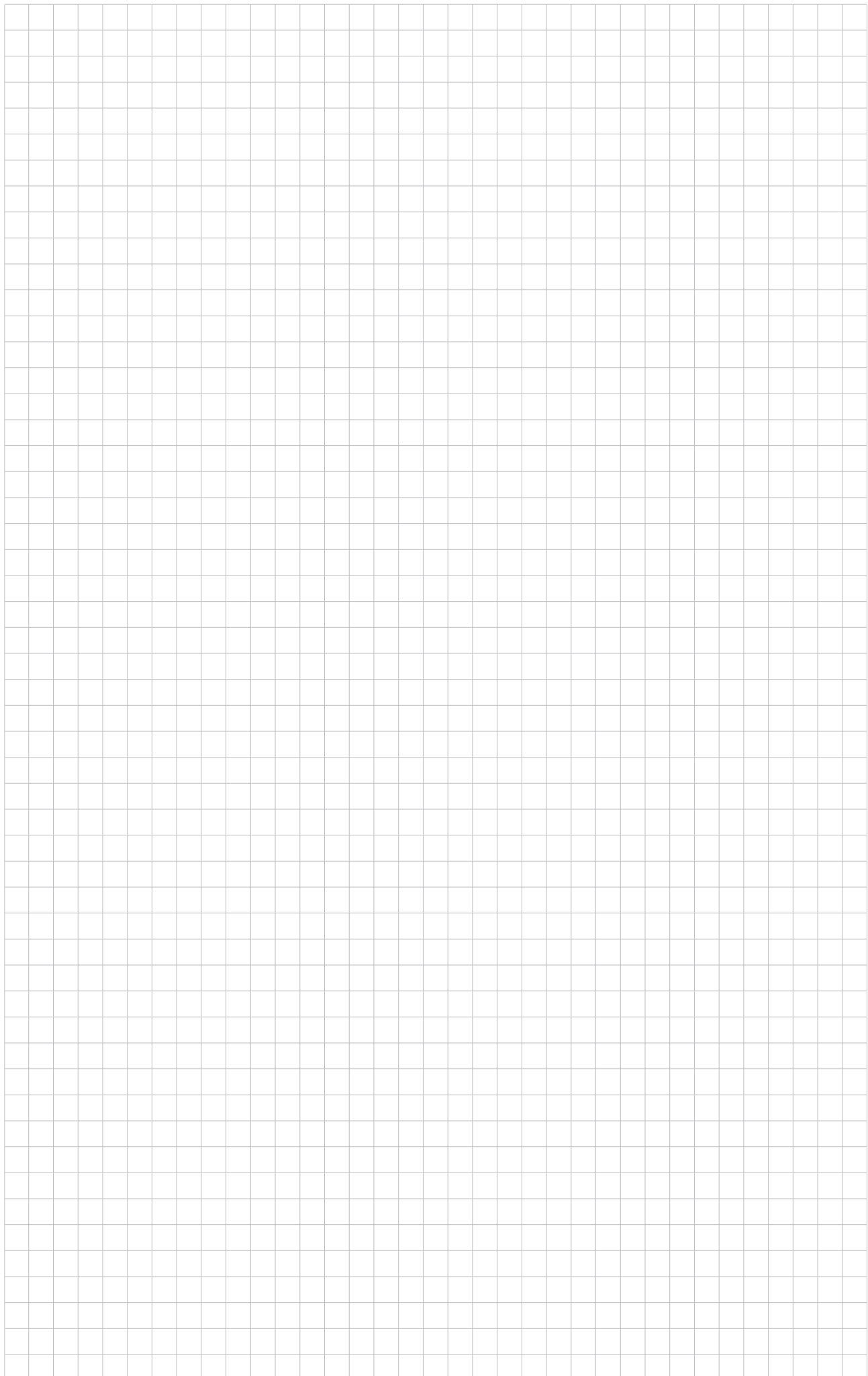

BRUMBERG

BRUMBERG Leuchten GmbH & Co. KG
Hellefelder Str. 63 | 59846 Sundern (Germany)
Fon: +49 (0) 29 34 / 96 11 0 | Fax: +49 (0) 29 34 / 96 11 96
info@brumberg.com | www.brumberg.com

PREMIUM MARKEN
Partner 

BRUMBERG Produkte erhalten Sie ausschließlich bei Ihrem Elektroinstallateur. Nach DIN VDE 0100 dürfen Einbau und Abnahmen elektrischer Geräte nur durch eine Elektro-Fachkraft erfolgen.

